

**This electronic collection of documents is provided
for the convenience of the user
and is Not a Certified Document –**

**The documents contained herein were originally issued
and sealed by the individuals whose names and license
numbers appear on each page, on the dates appearing
with their signature on that page.**

**This file or an individual page
shall not be considered a certified document.**

CROSS SECTION INDEX

X-1 CROSS SECTION INDEX

X-1A CROSS SECTION SUMMARY

X-2 THRU X-46 -L-

X-47 -Y1-

X-48 THRU X-49 -Y4-

X-50 THRU X-52 -Y6-

X-53 -Y8-

X-54 THRU X-56 -Y9-

8/23/99

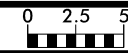

PROJ. REFERENCE NO.	SHEET NO.
W-5206AM	X-2

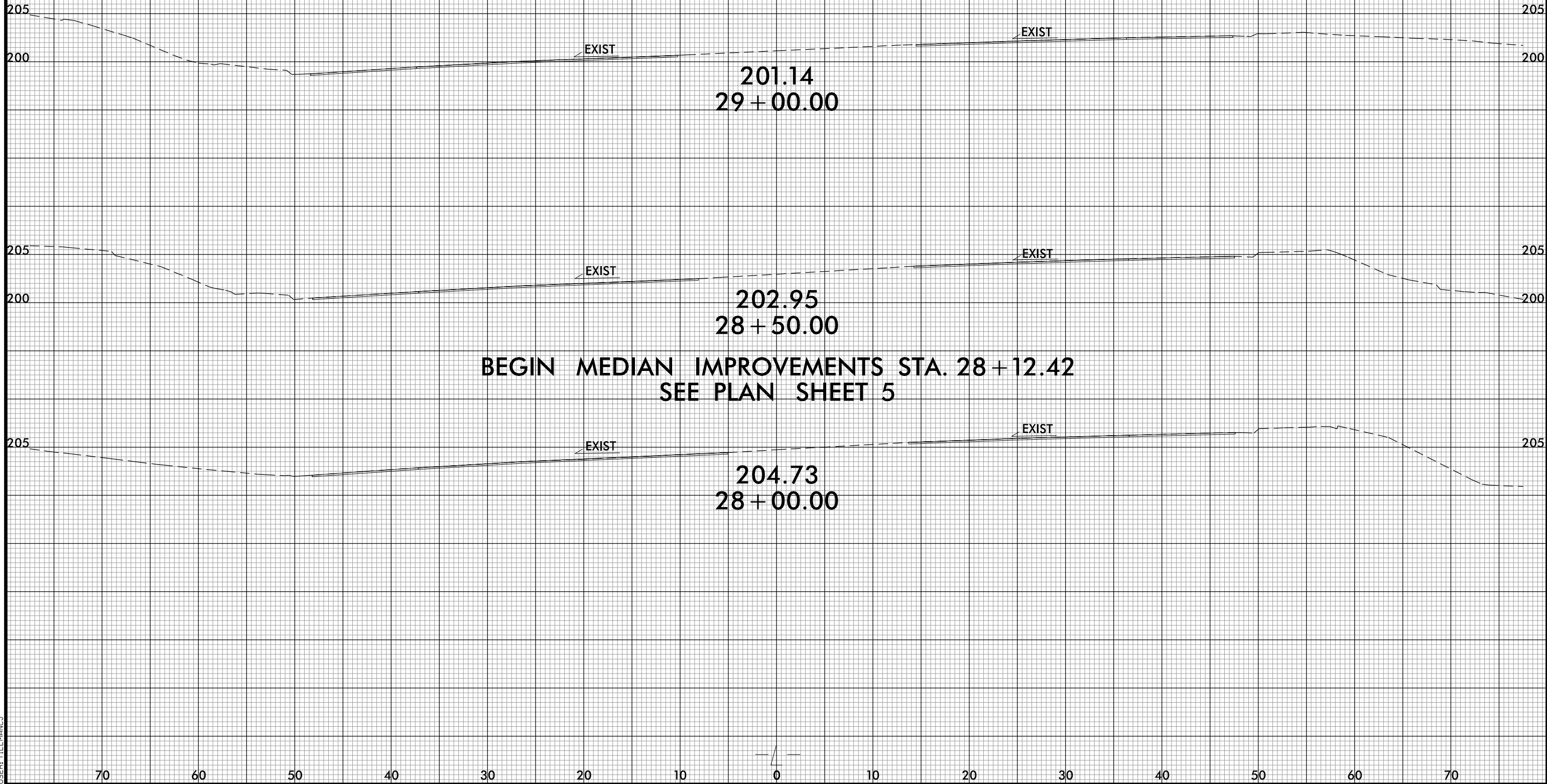

**BEGIN MEDIAN IMPROVEMENTS STA. 28 + 12.42
SEE PLAN SHEET 5**

invalid expression
USER: \\W5206AM1.Pdu...xp1.br.agg.dgn

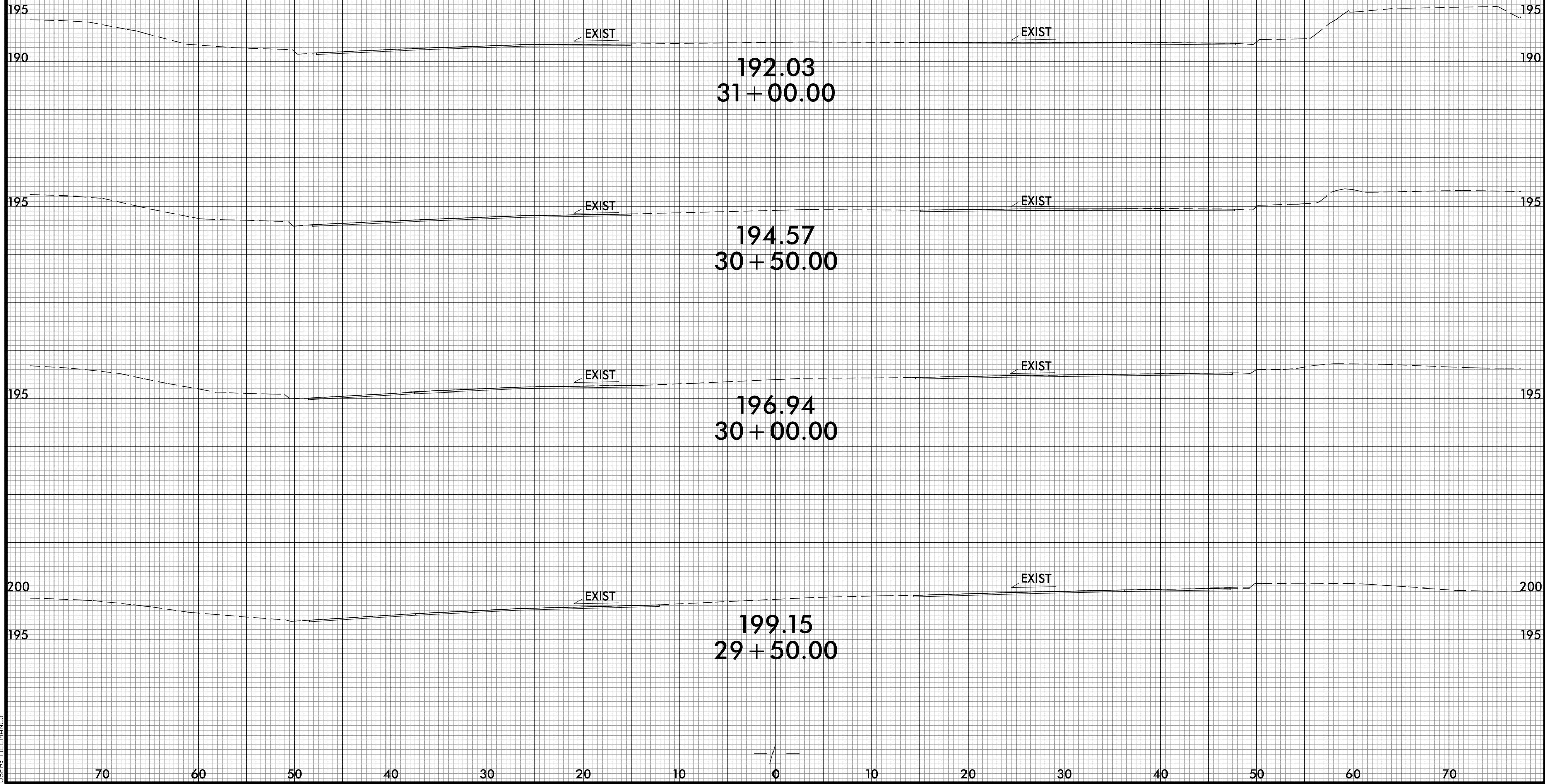

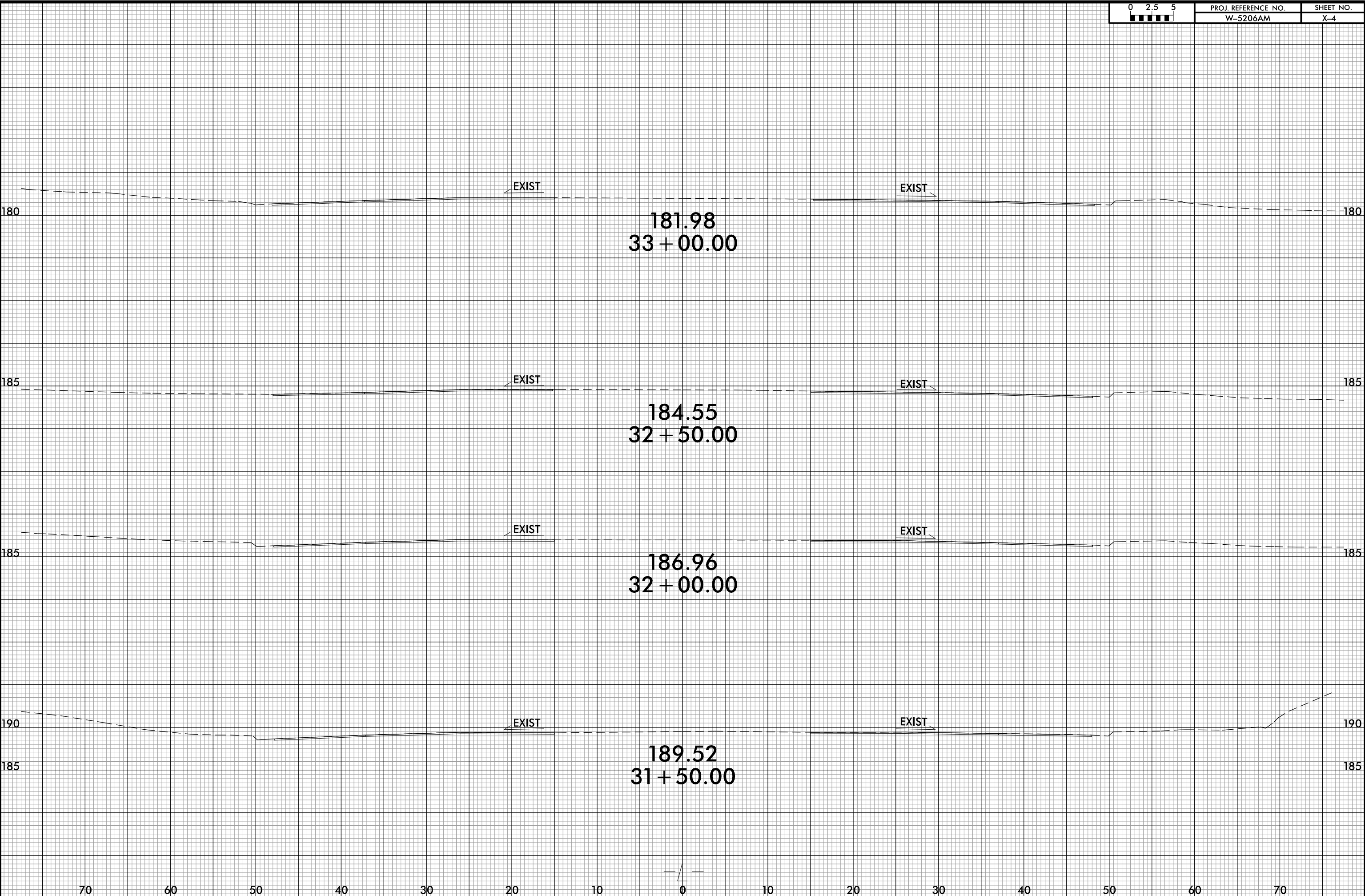

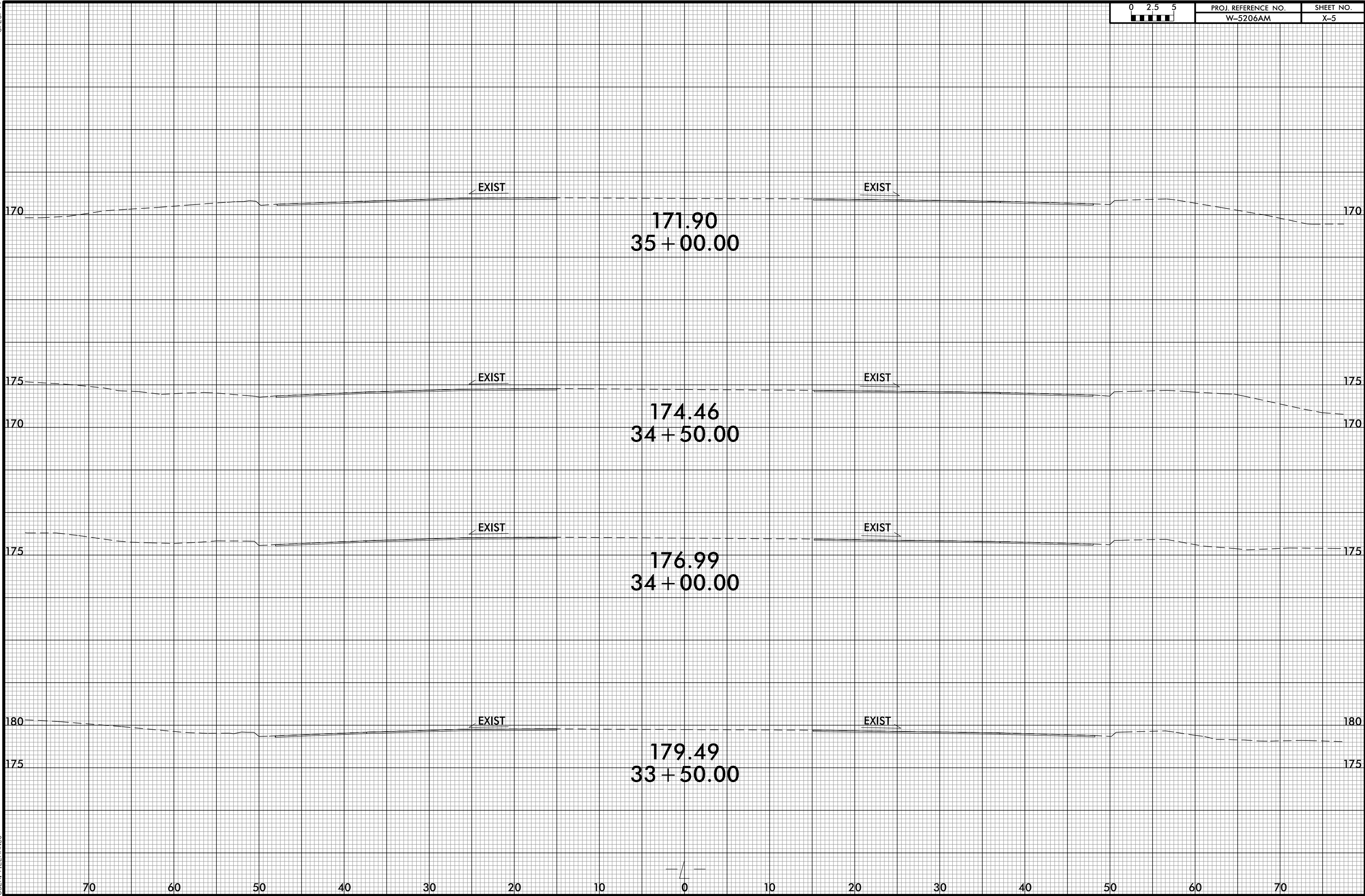

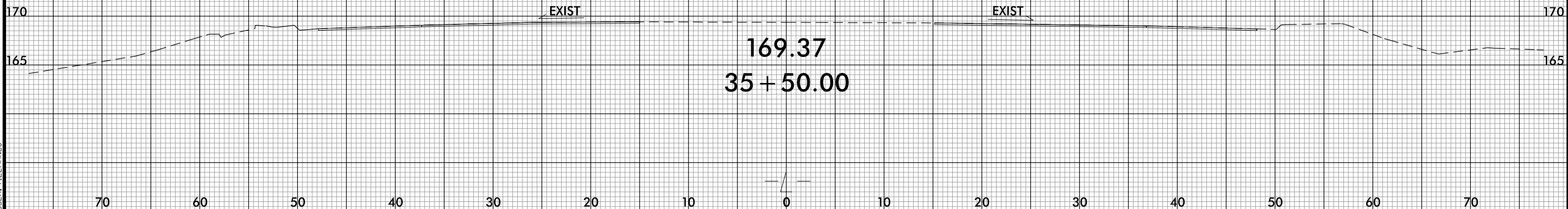
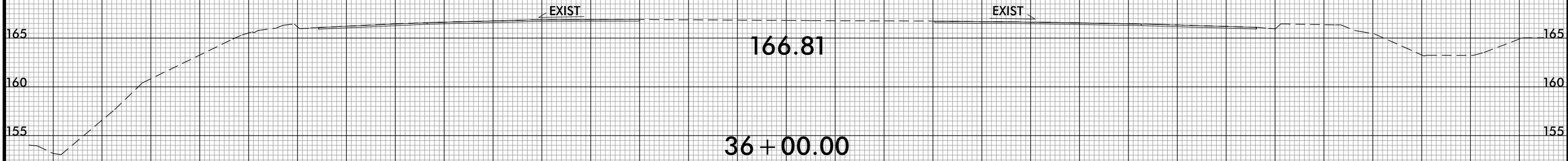
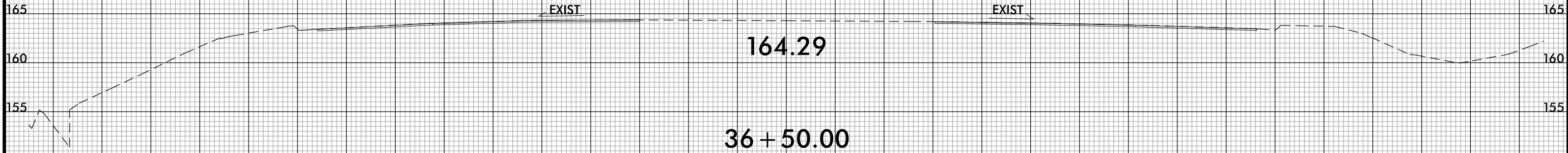

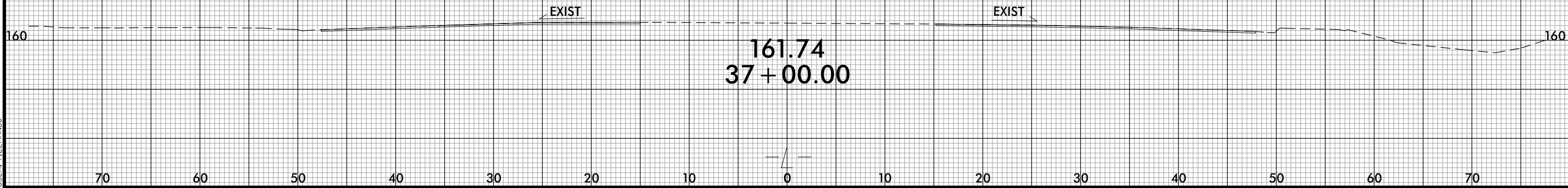
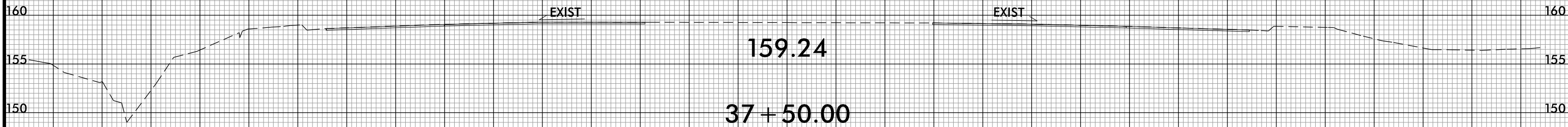
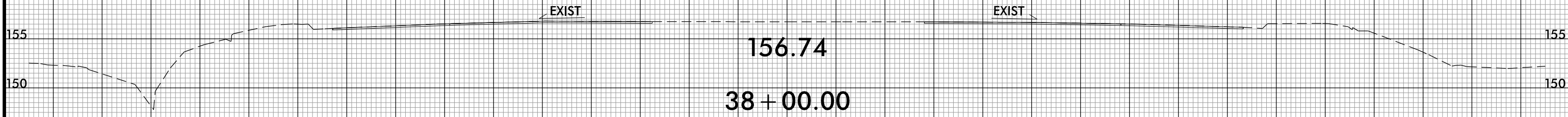
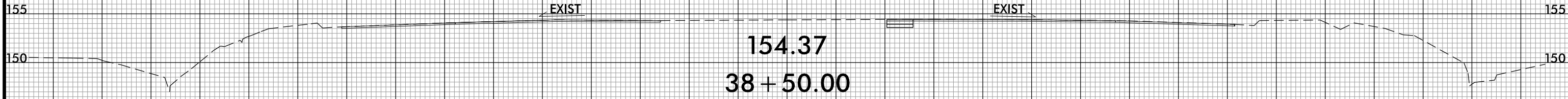
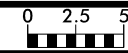

8/23/99



PROJ. REFERENCE NO.	SHEET NO.
W-5206AM	X-8

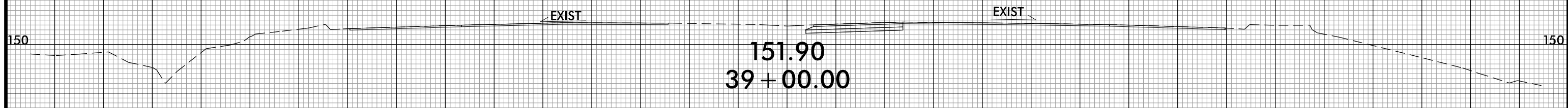
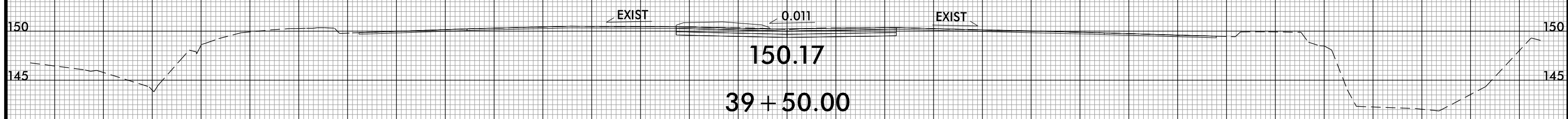
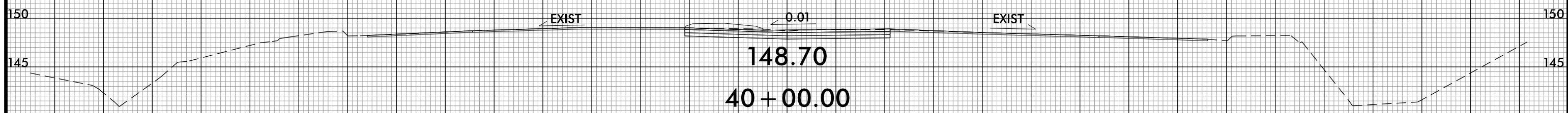
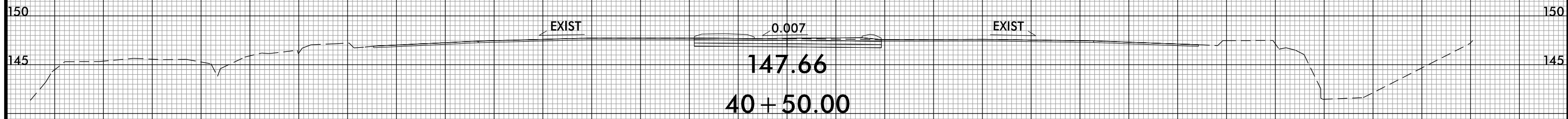

invalid expression
USER: \\W5206AM1.Pdu...xp1.br.agg.dgn

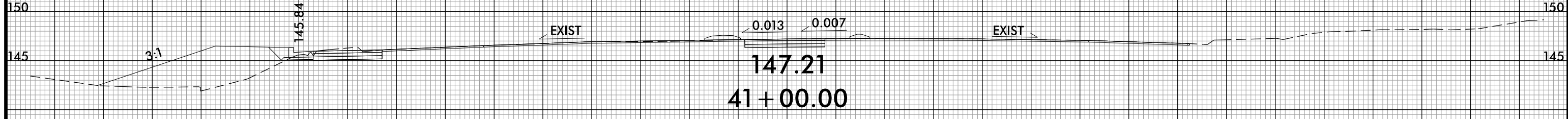
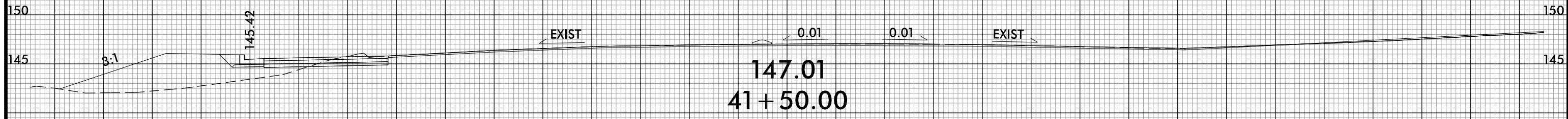
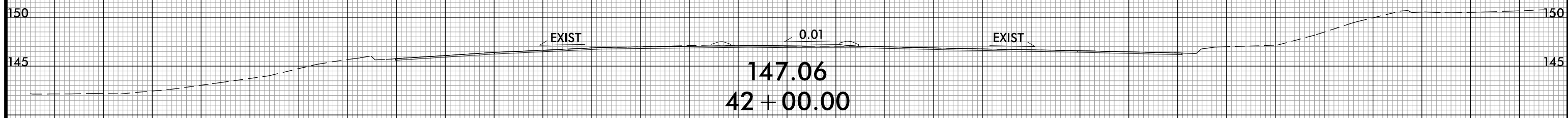
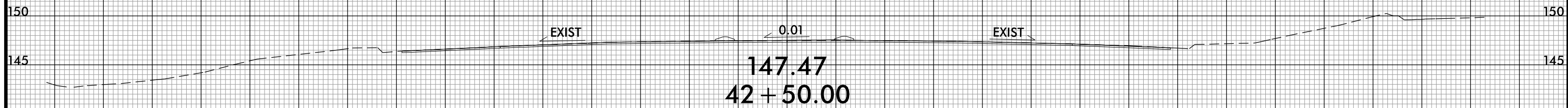

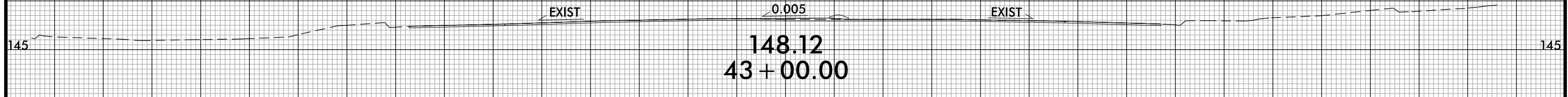
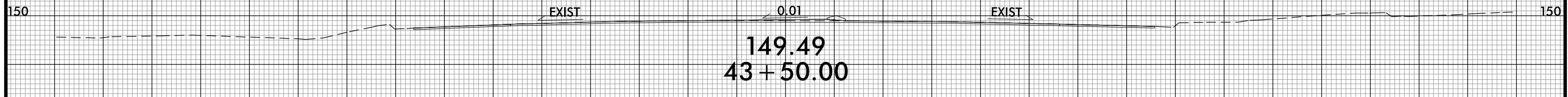
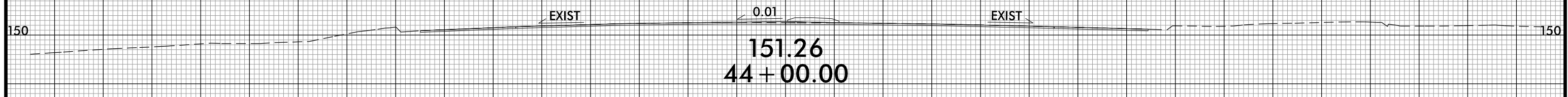
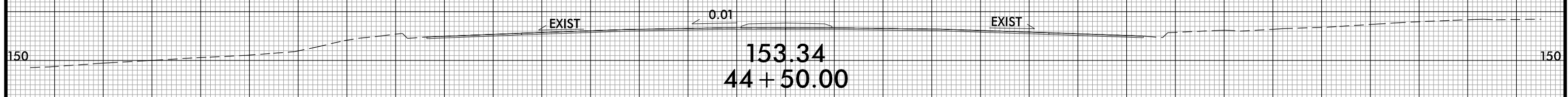

70 60 50 40 30 20 10 0 10 20 30 40 50 60 70

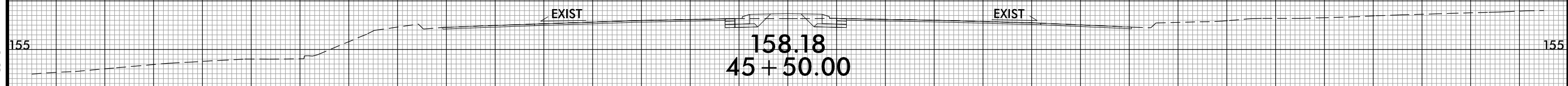
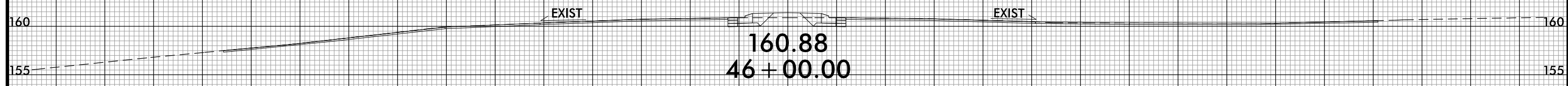
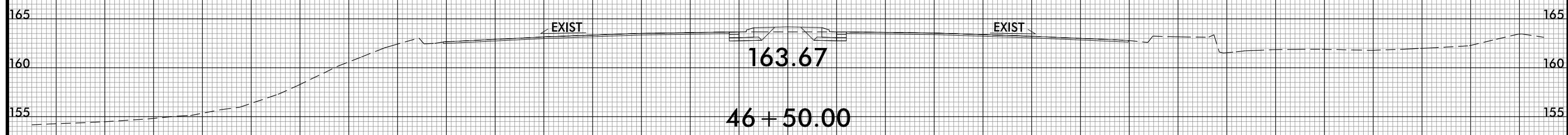
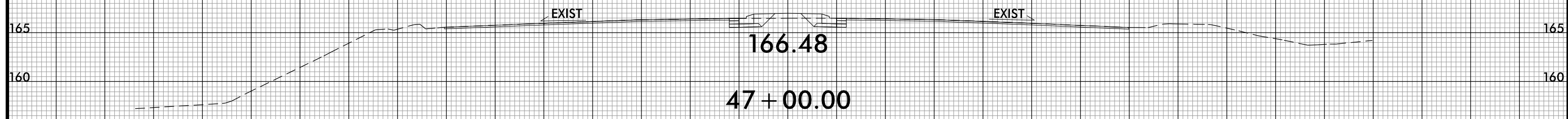

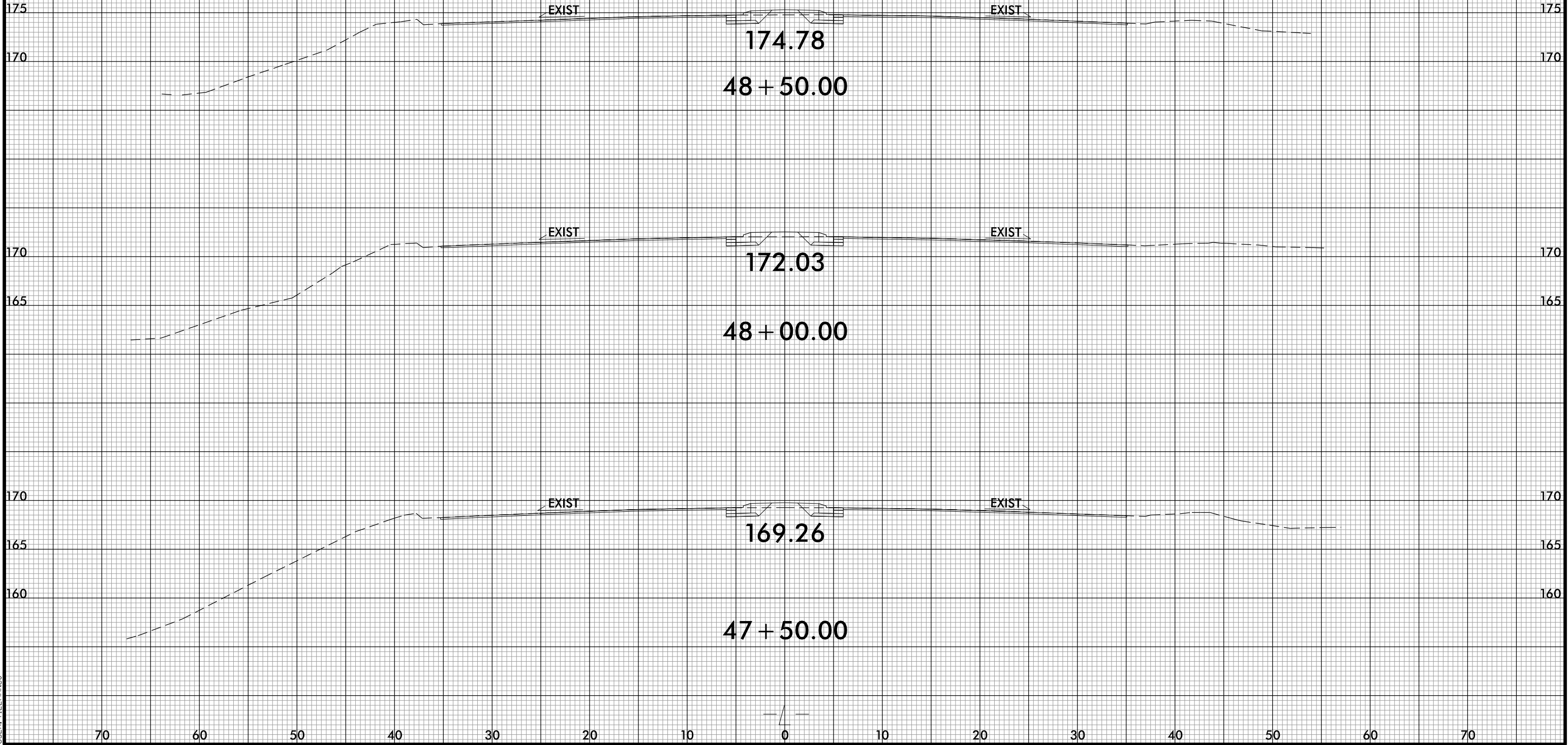

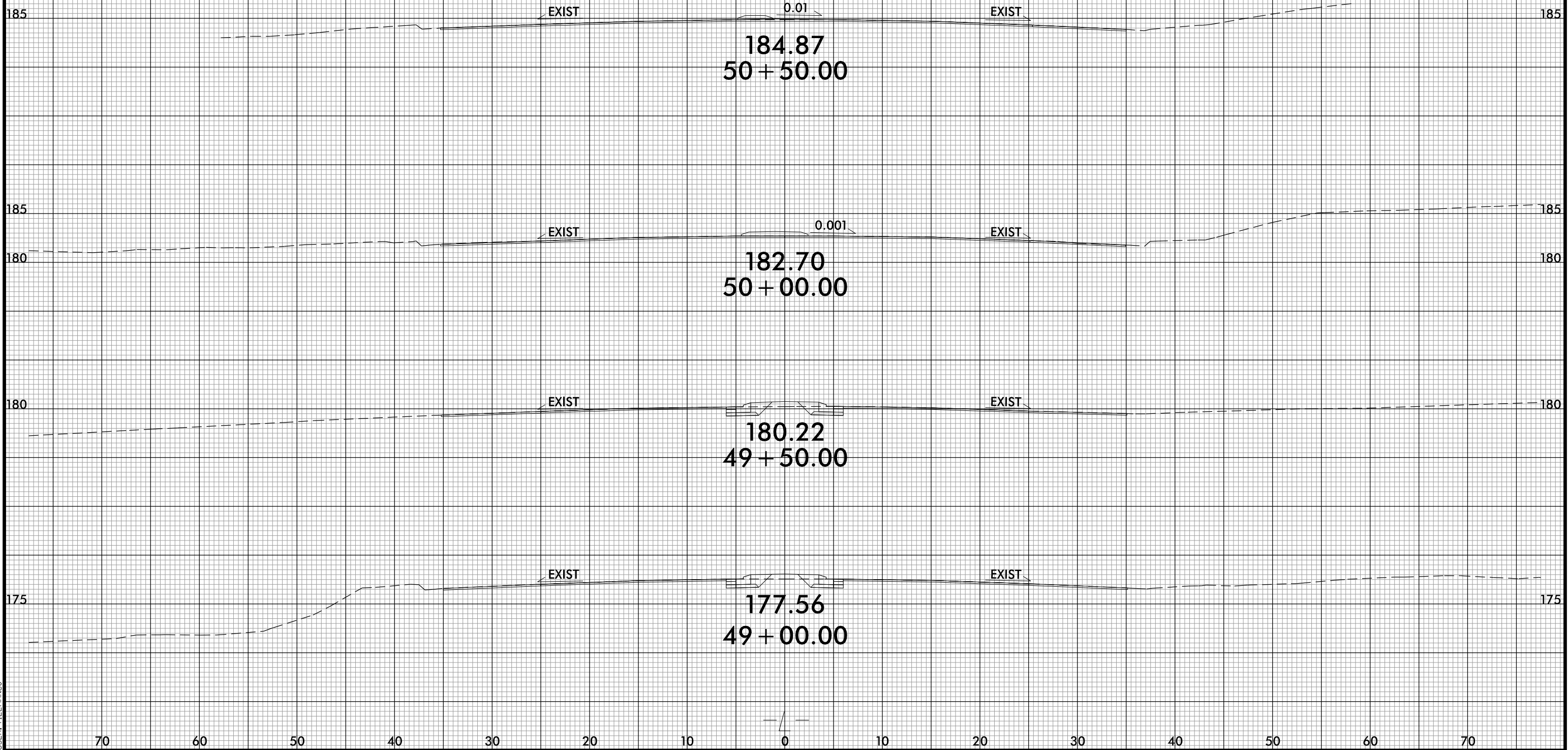
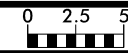

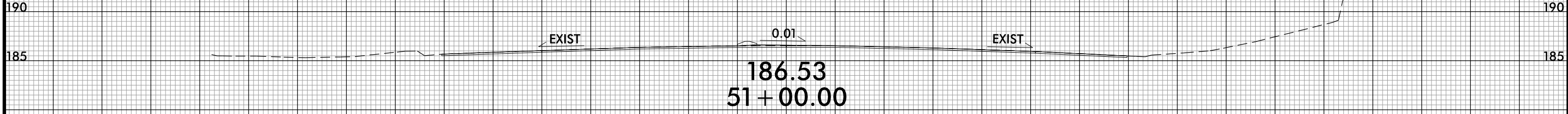
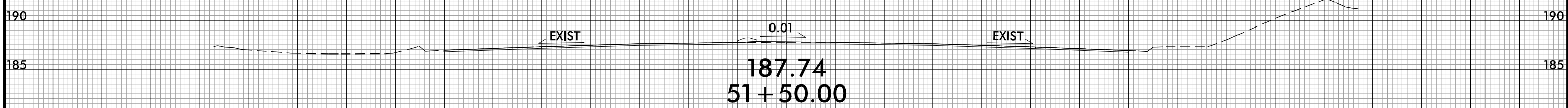
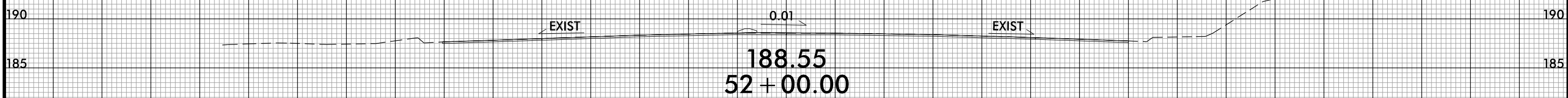
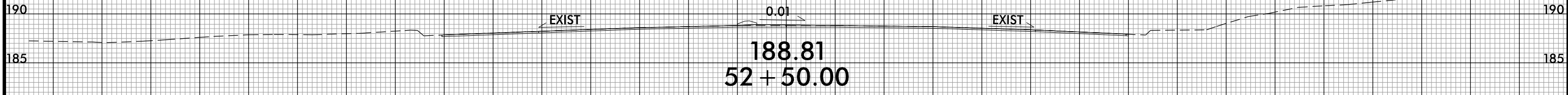

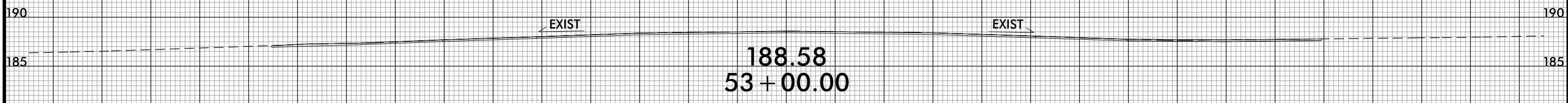
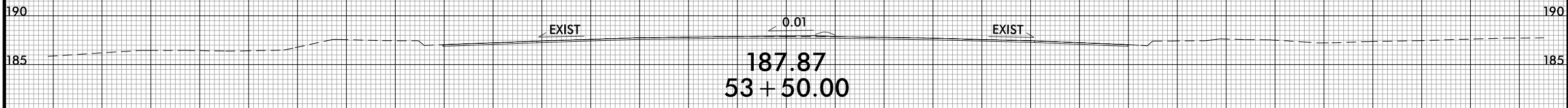
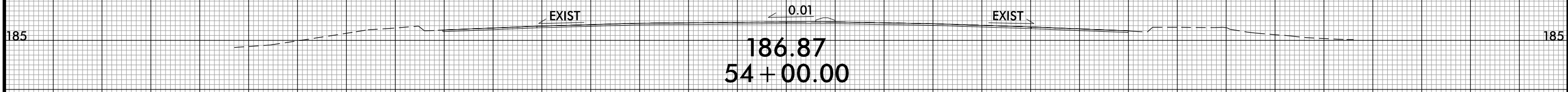
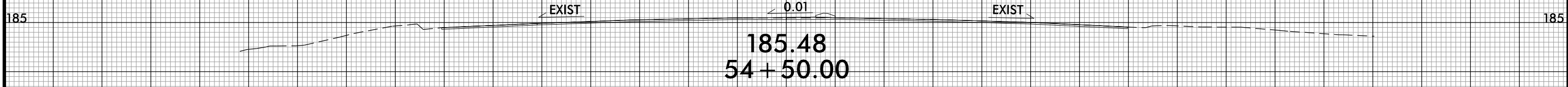

70 60 50 40 30 20 10 0 10 20 30 40 50 60 70

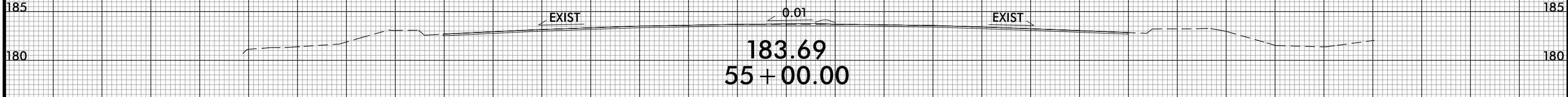
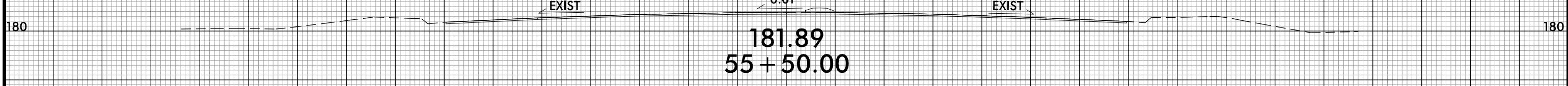
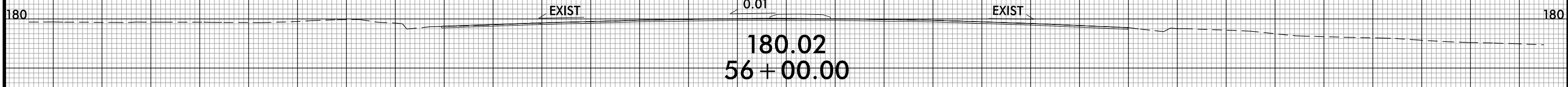
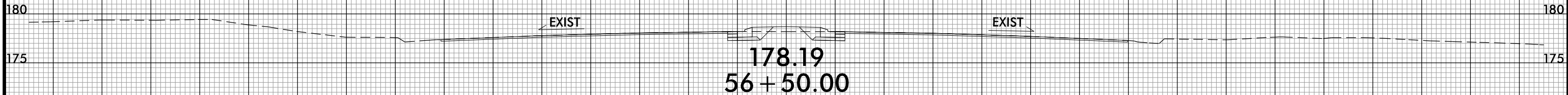

8/23/99

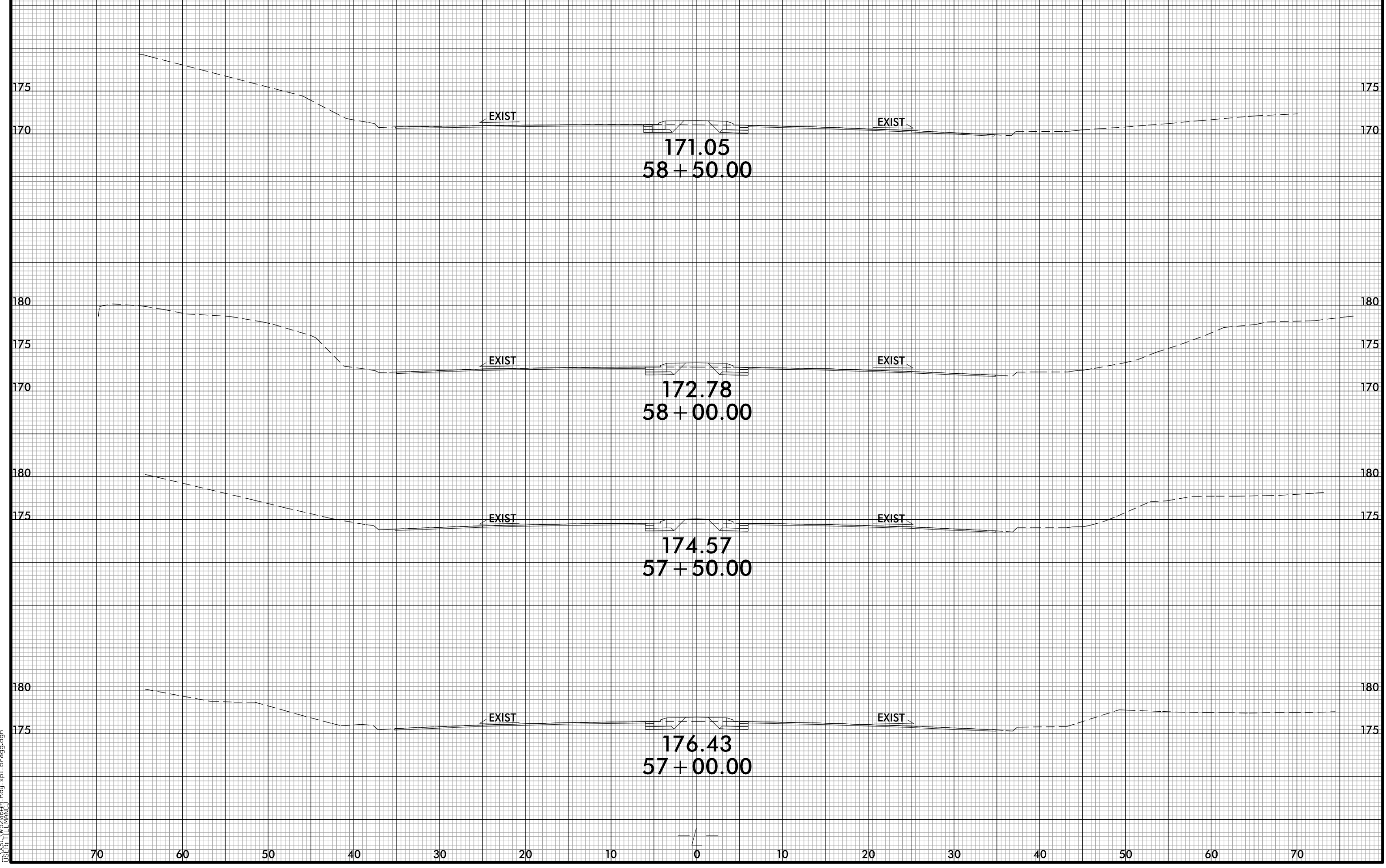

invalid expression
 \\psc-ws206am\rdy-xp1-bragg.dgn
 USER: TLLMANCJ

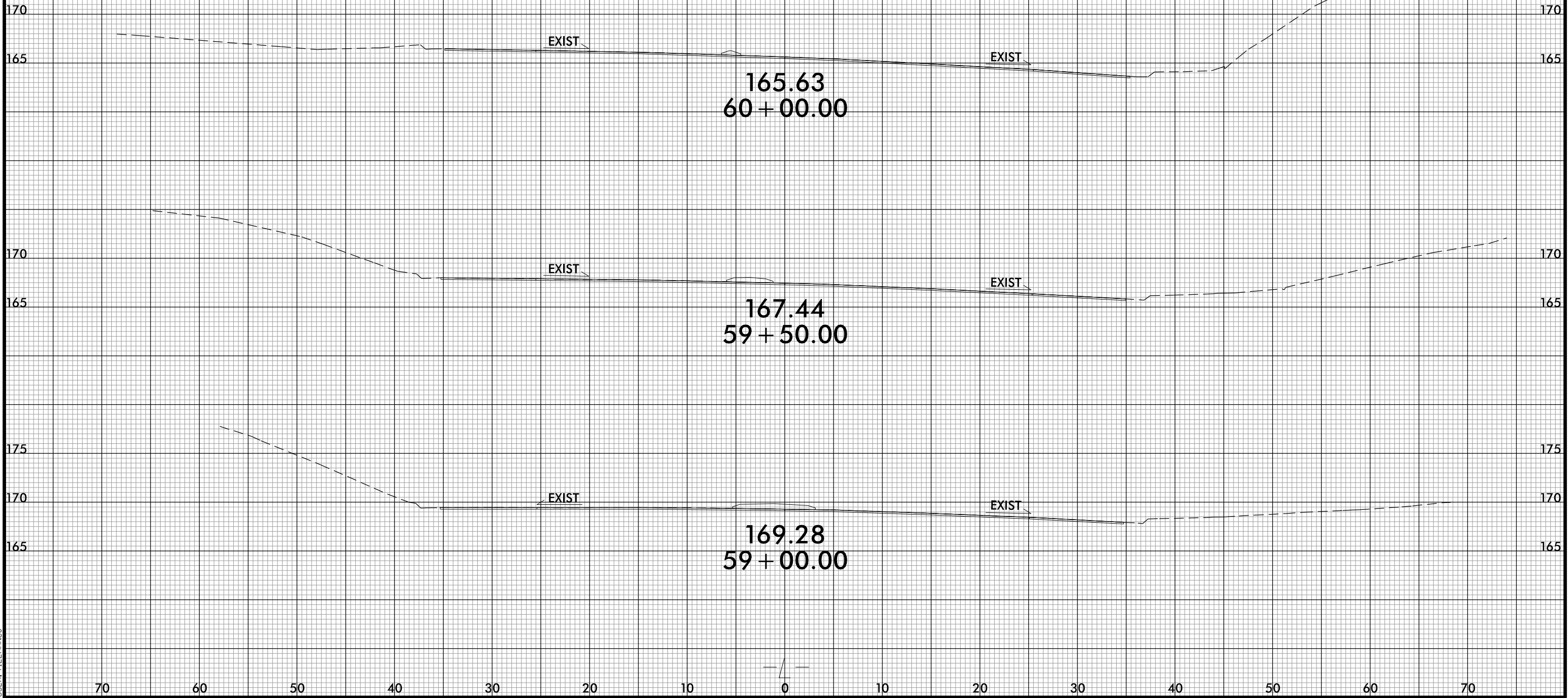
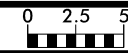

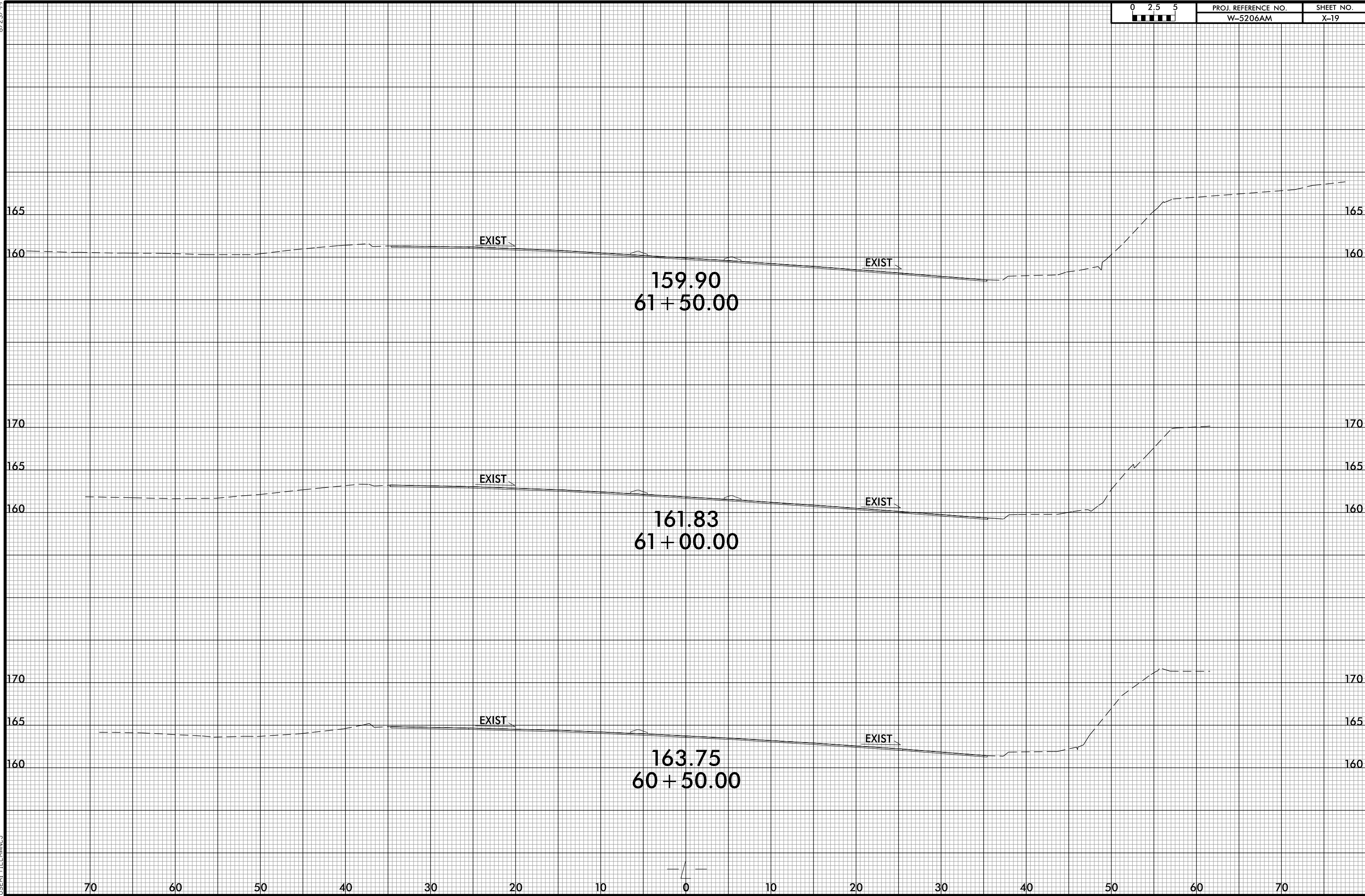
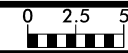

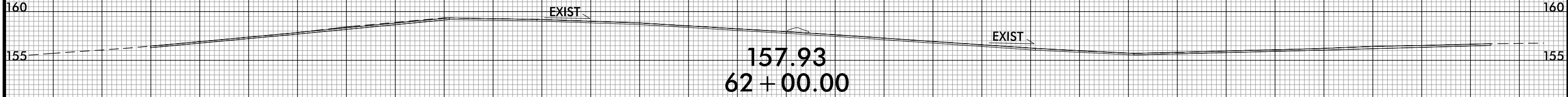
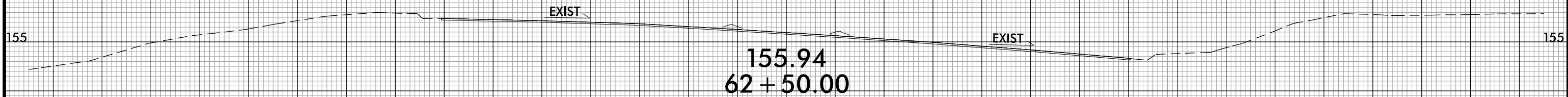
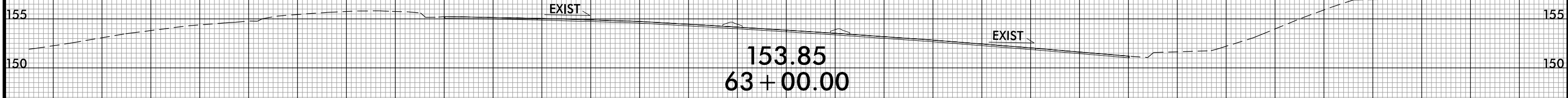
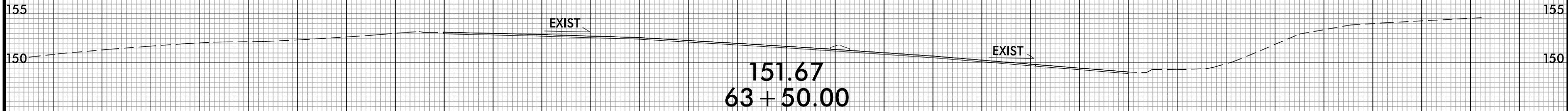

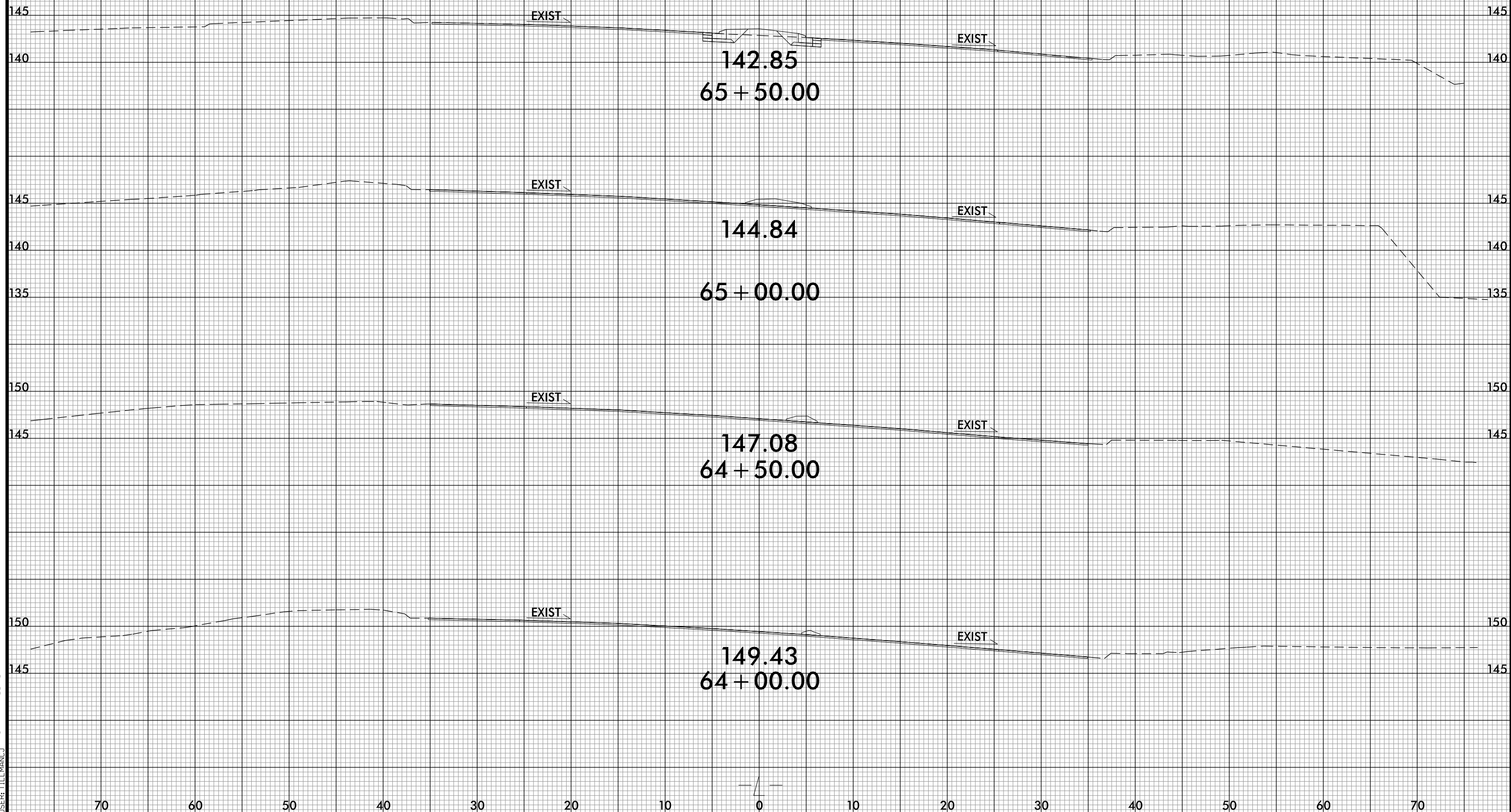
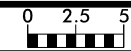

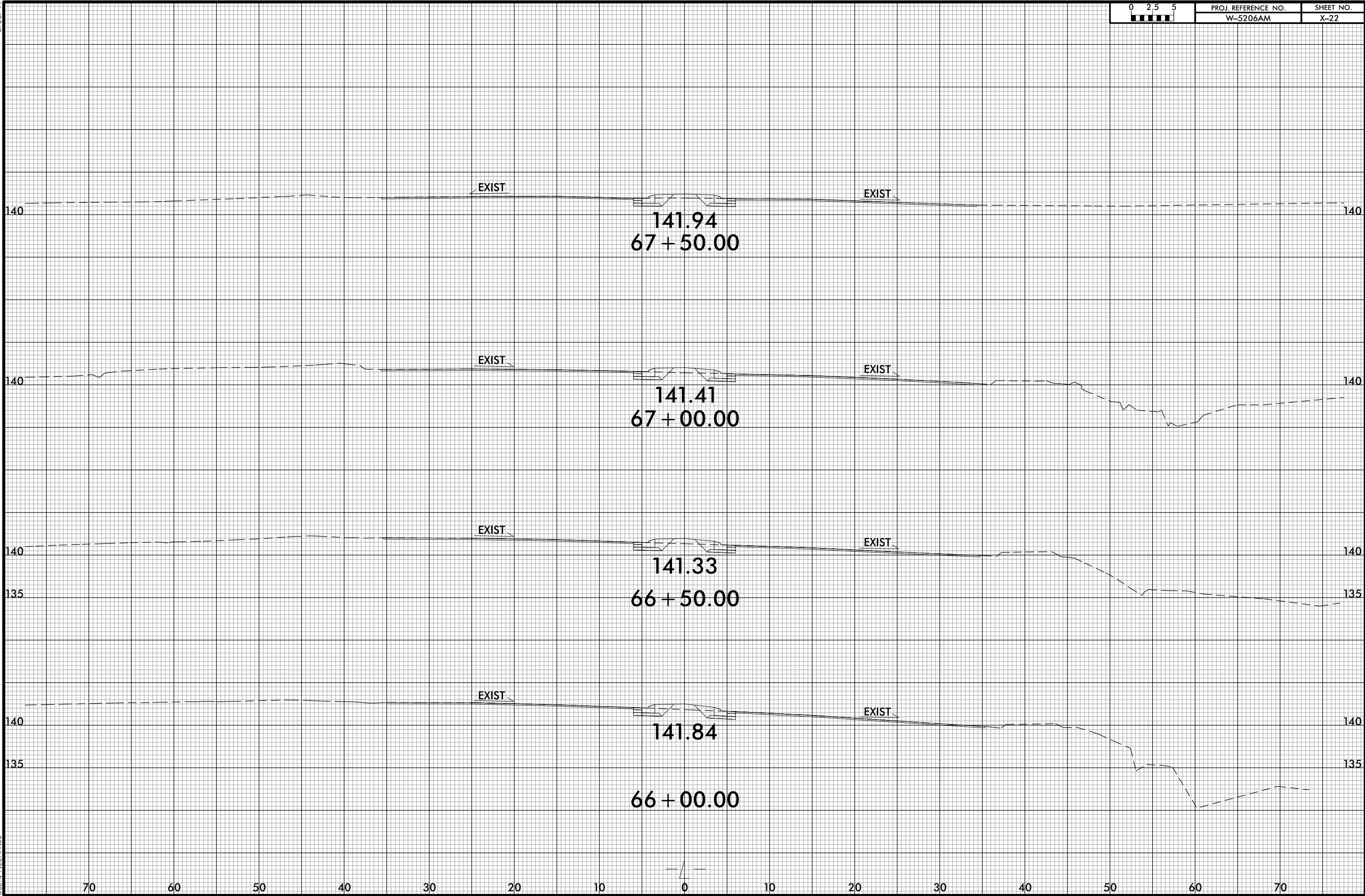

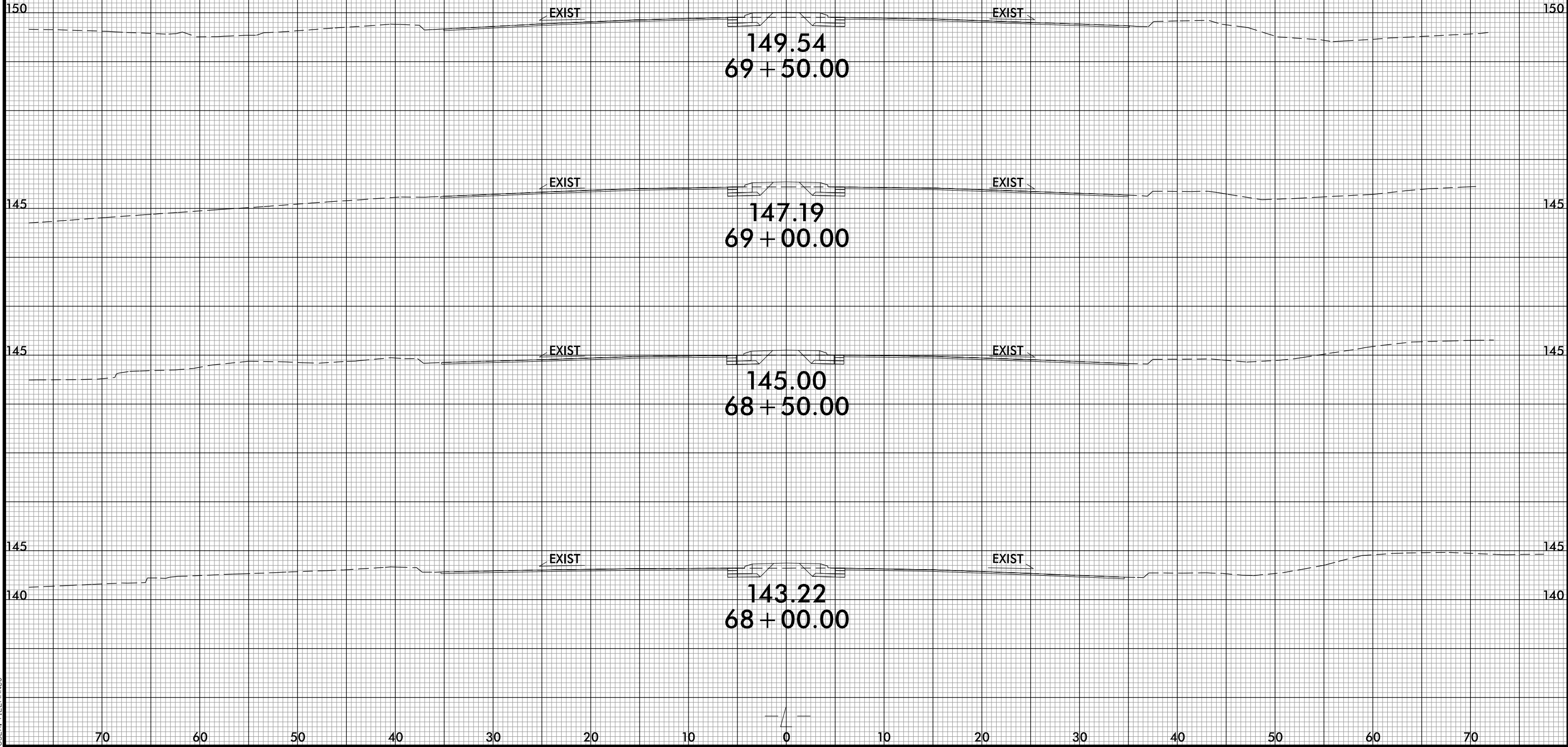

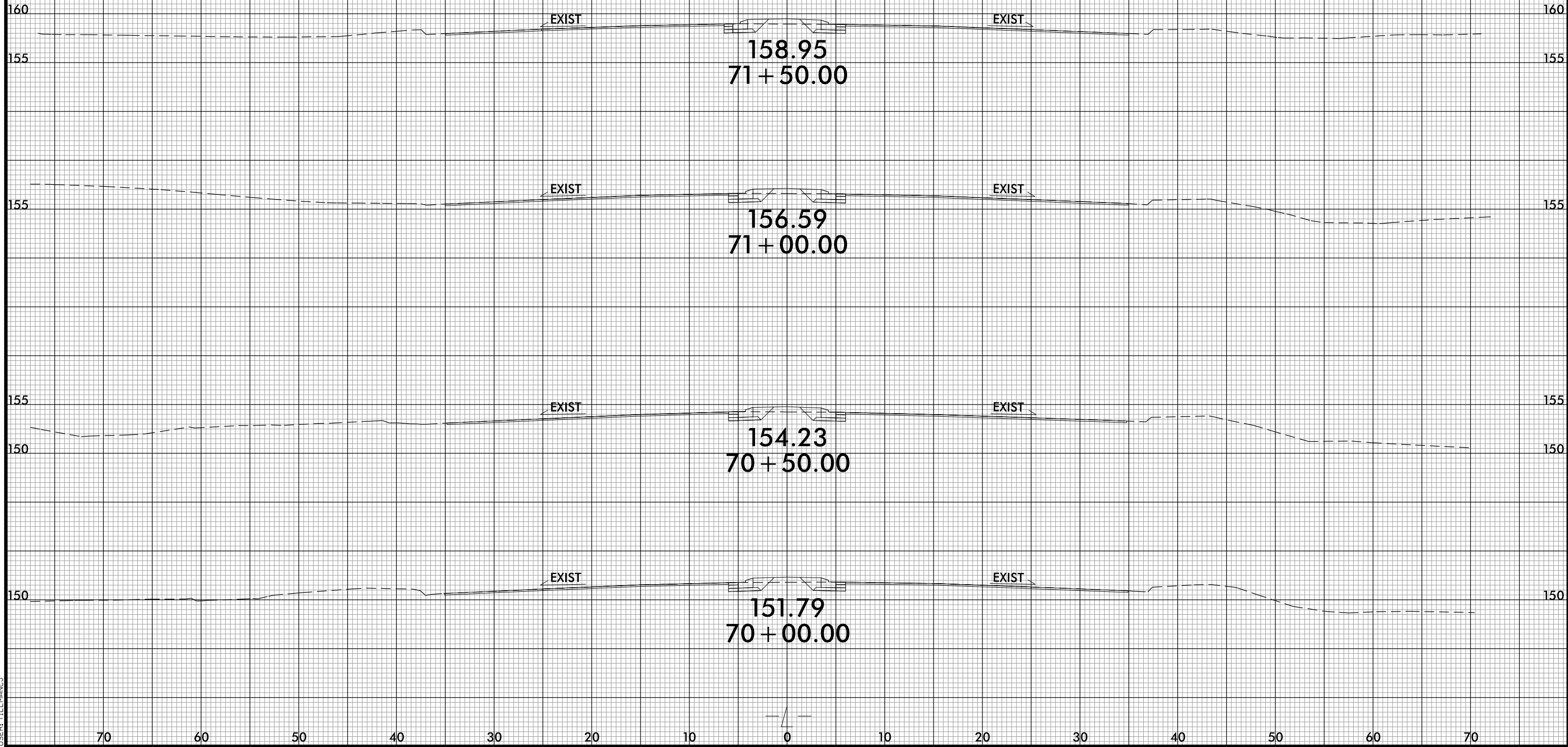

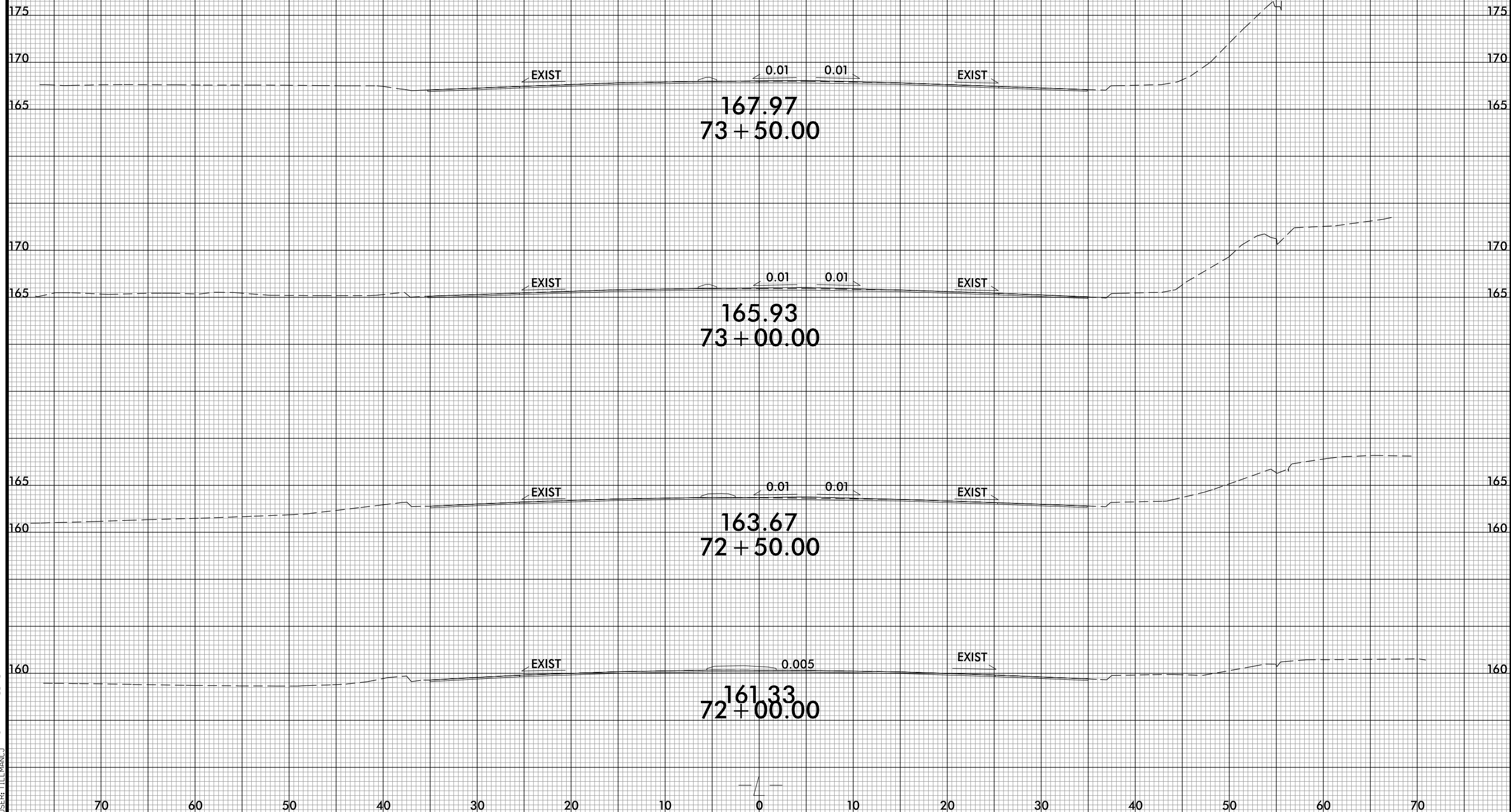

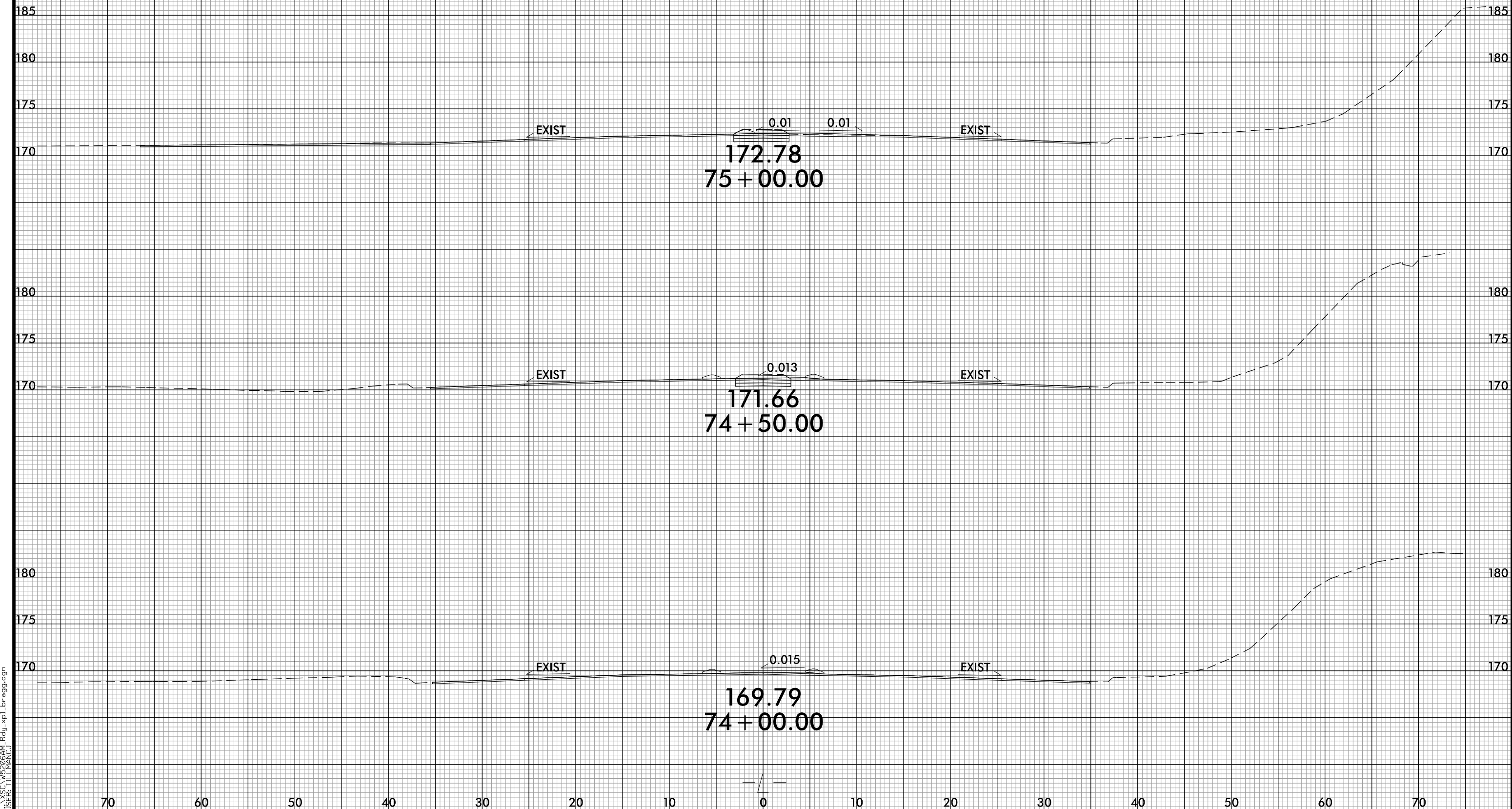

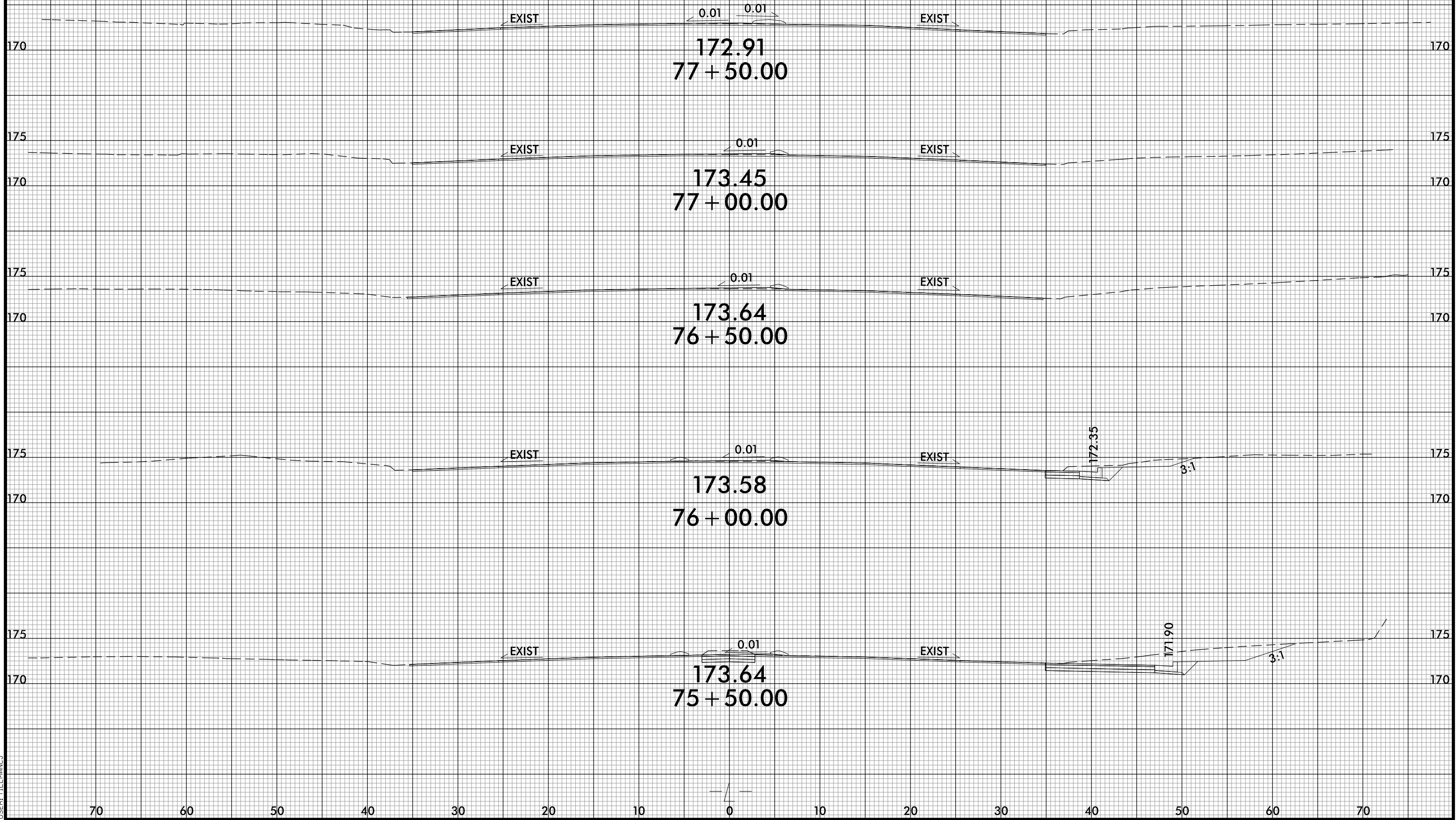

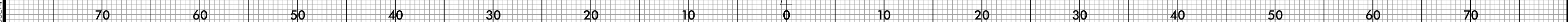
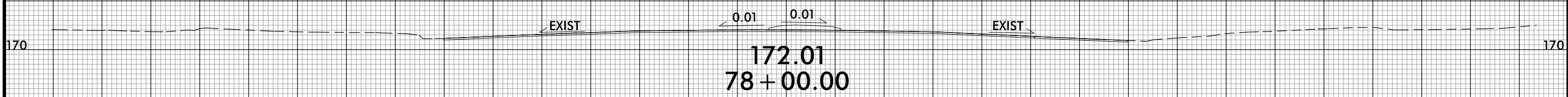
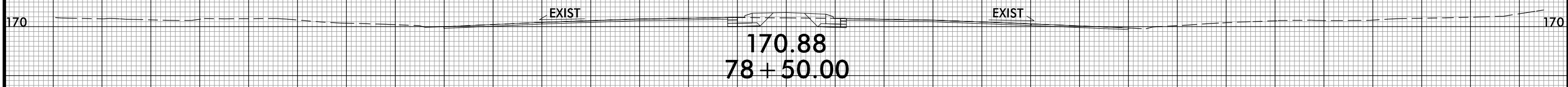
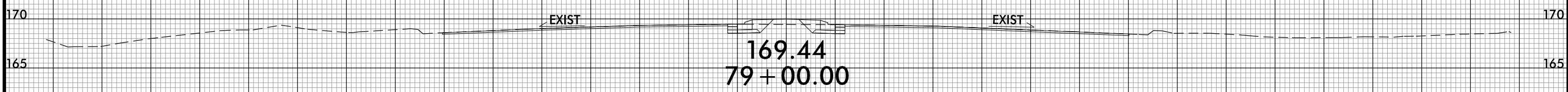
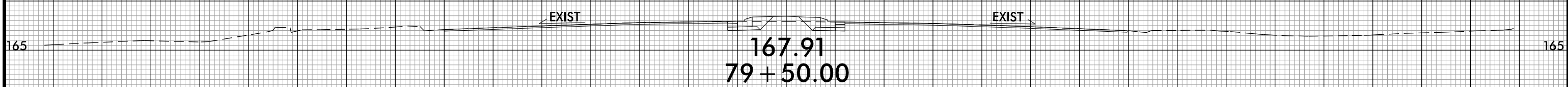
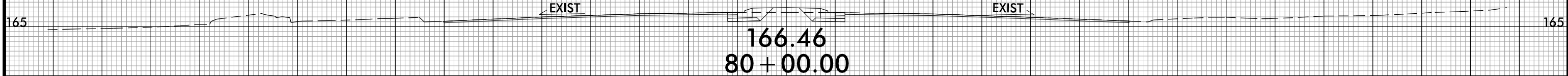

invalid expression
USER: \\W5206AM1.Pdu_xp1.br.agg.dgn

8/23/99



PROJ. REFERENCE NO.
W-5206AM

SHEET NO.
X-29

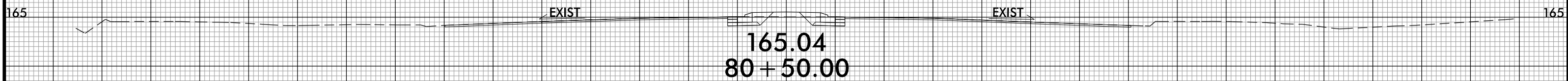
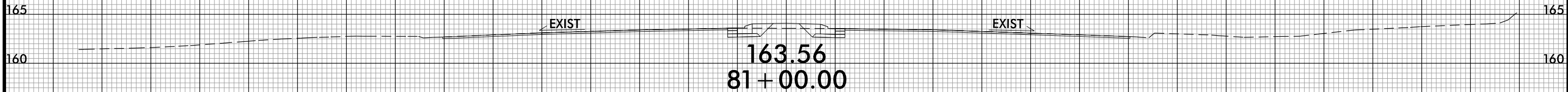
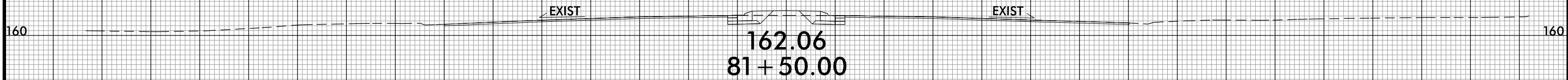
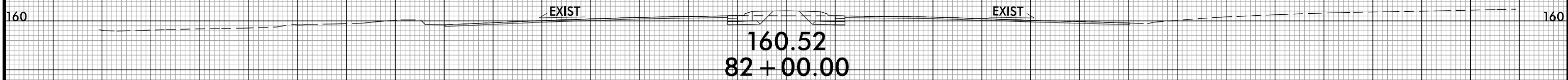
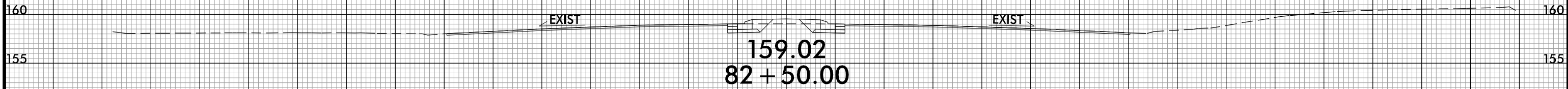

invalid expression
USER: TLEMANCJ
PROJECT: W-5206AM.P01.br.agg.dgn

70 60 50 40 30 20 10 0 10 20 30 40 50 60 70

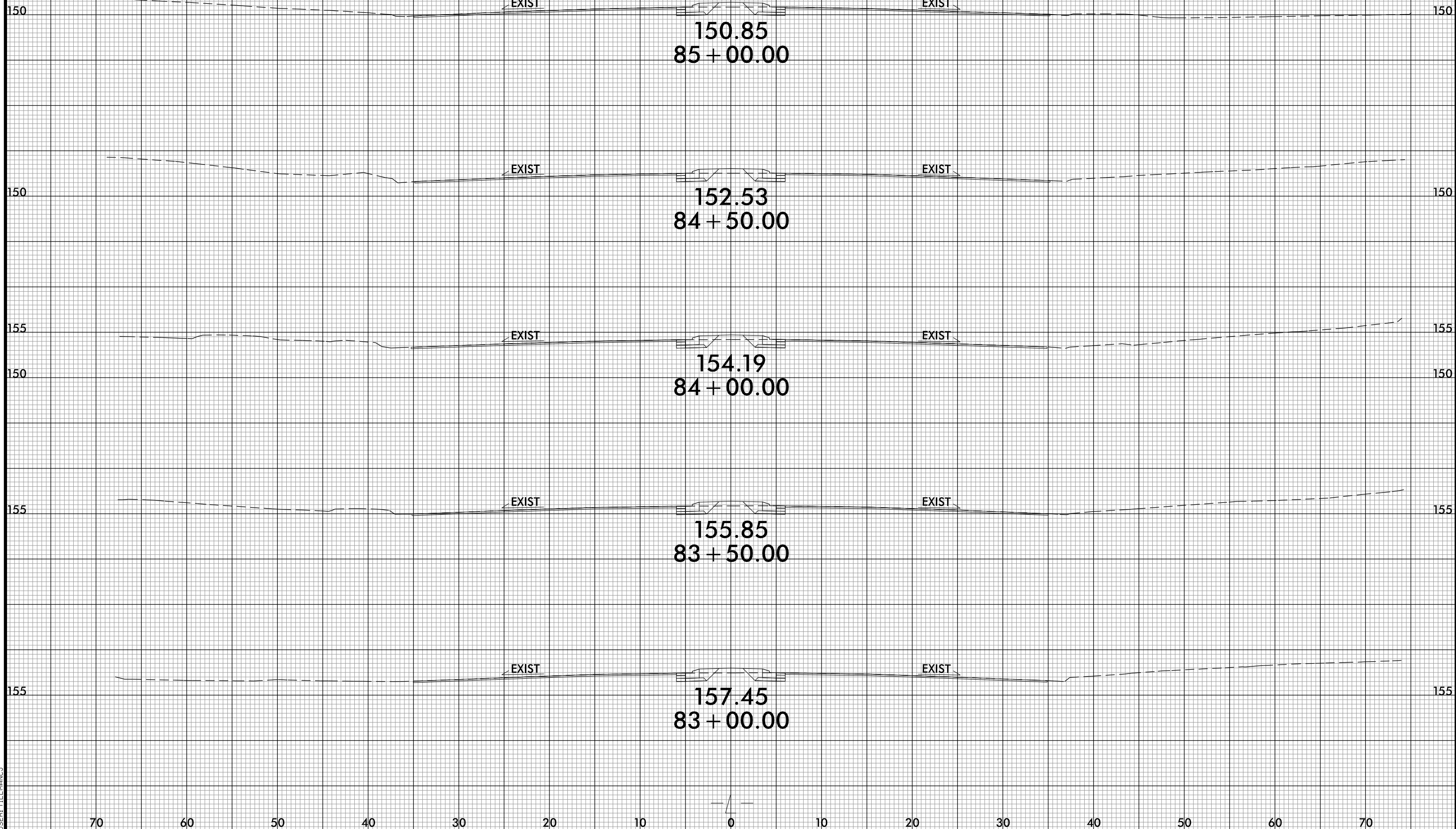

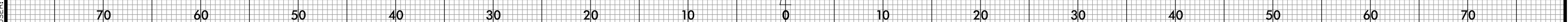
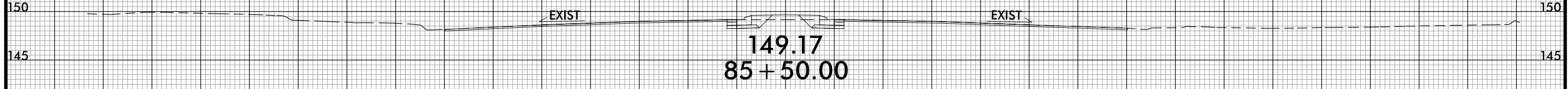
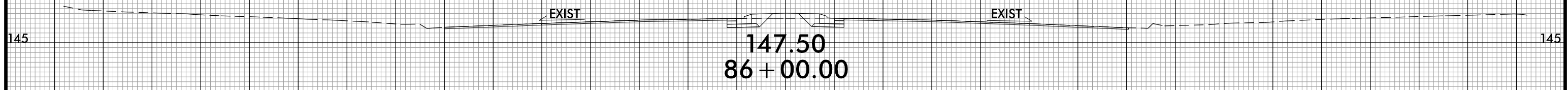
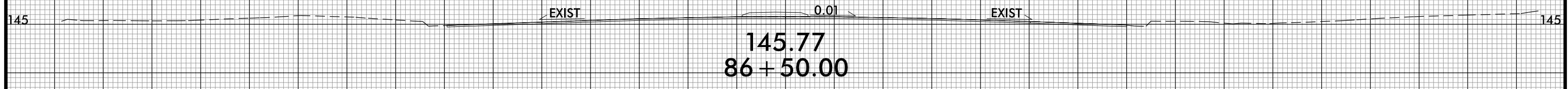
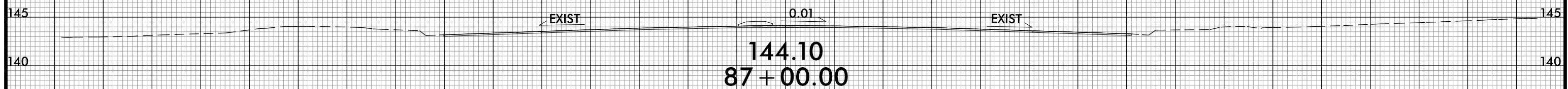
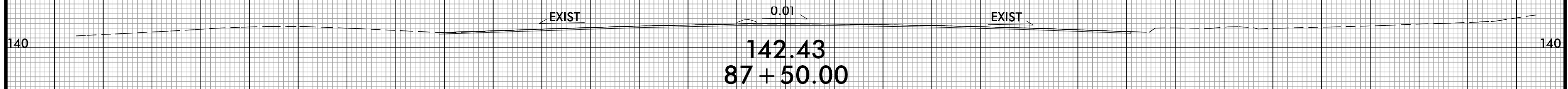

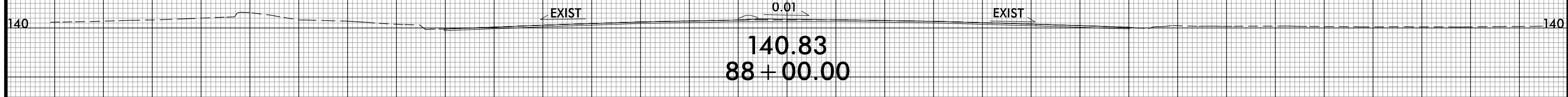
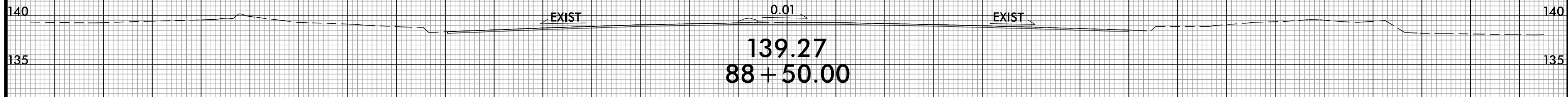
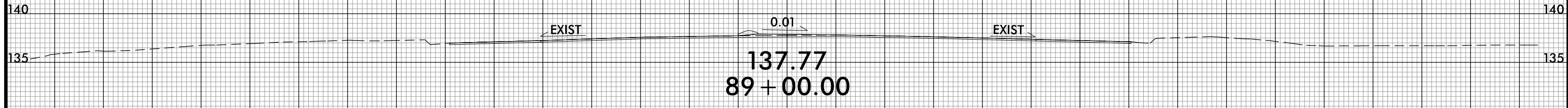
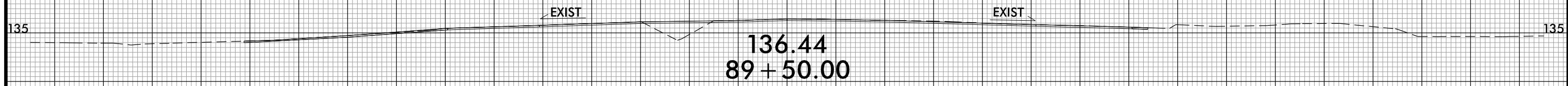

70 60 50 40 30 20 10 0 10 20 30 40 50 60 70

8/23/99

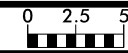

PROJ. REFERENCE NO.
W-5206AM

SHEET NO.
X-33

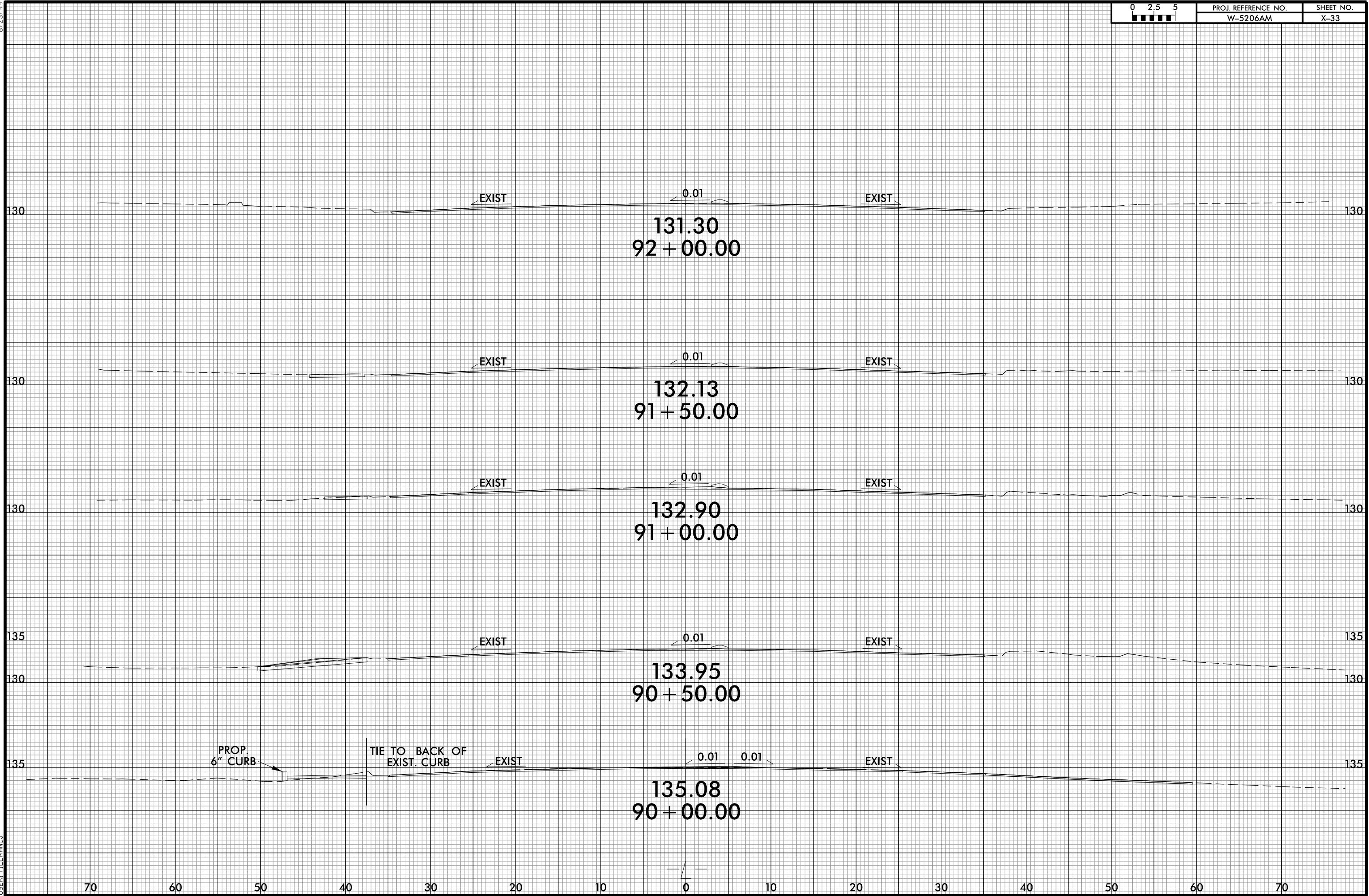

PROP.
6" CURB

TIE TO BACK OF
EXIST. CURB

EXIST

EXIST

invalid expression
USER: \\W5206AM1.Pdu...xp1.br.agg.dgn

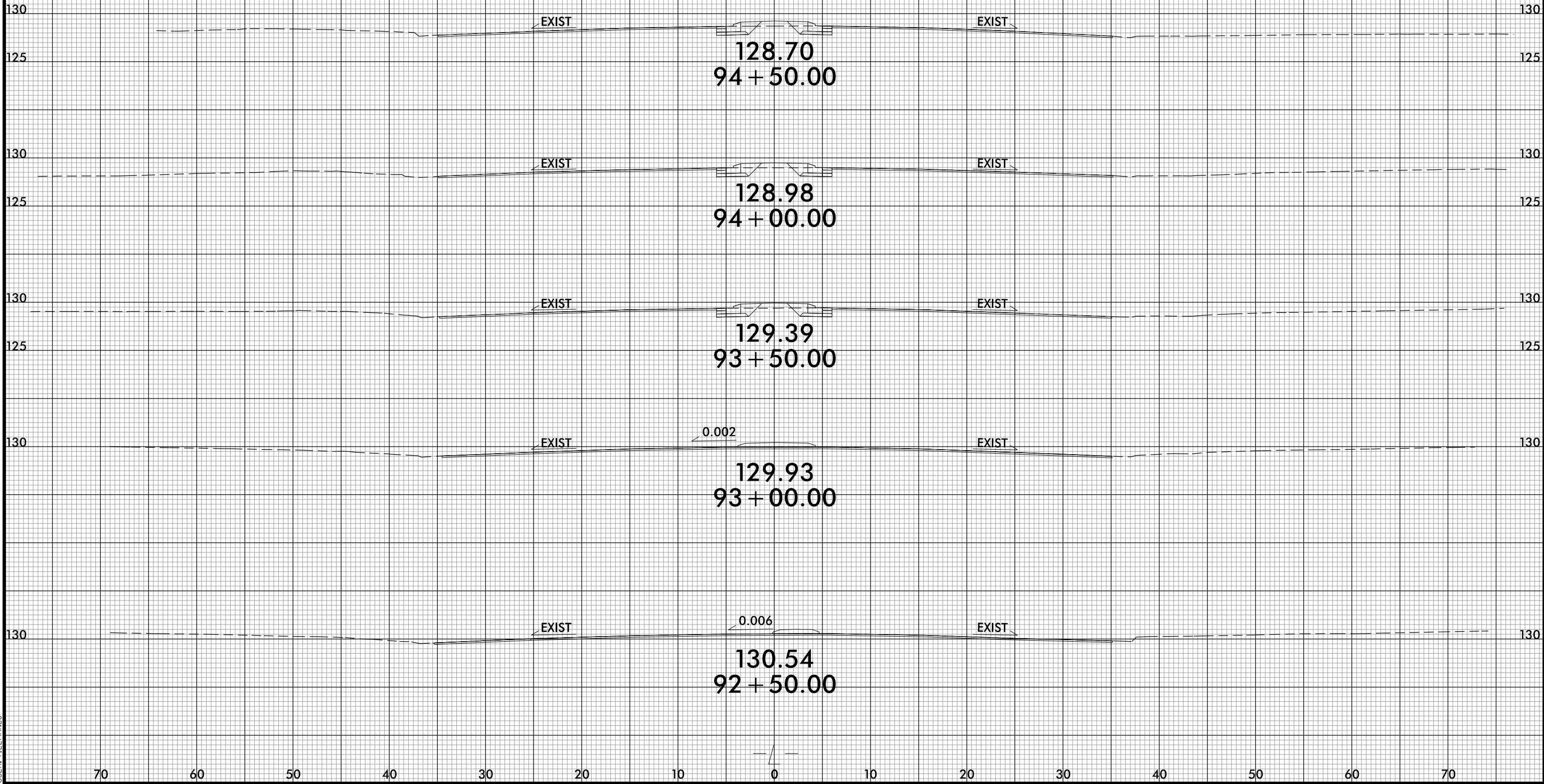

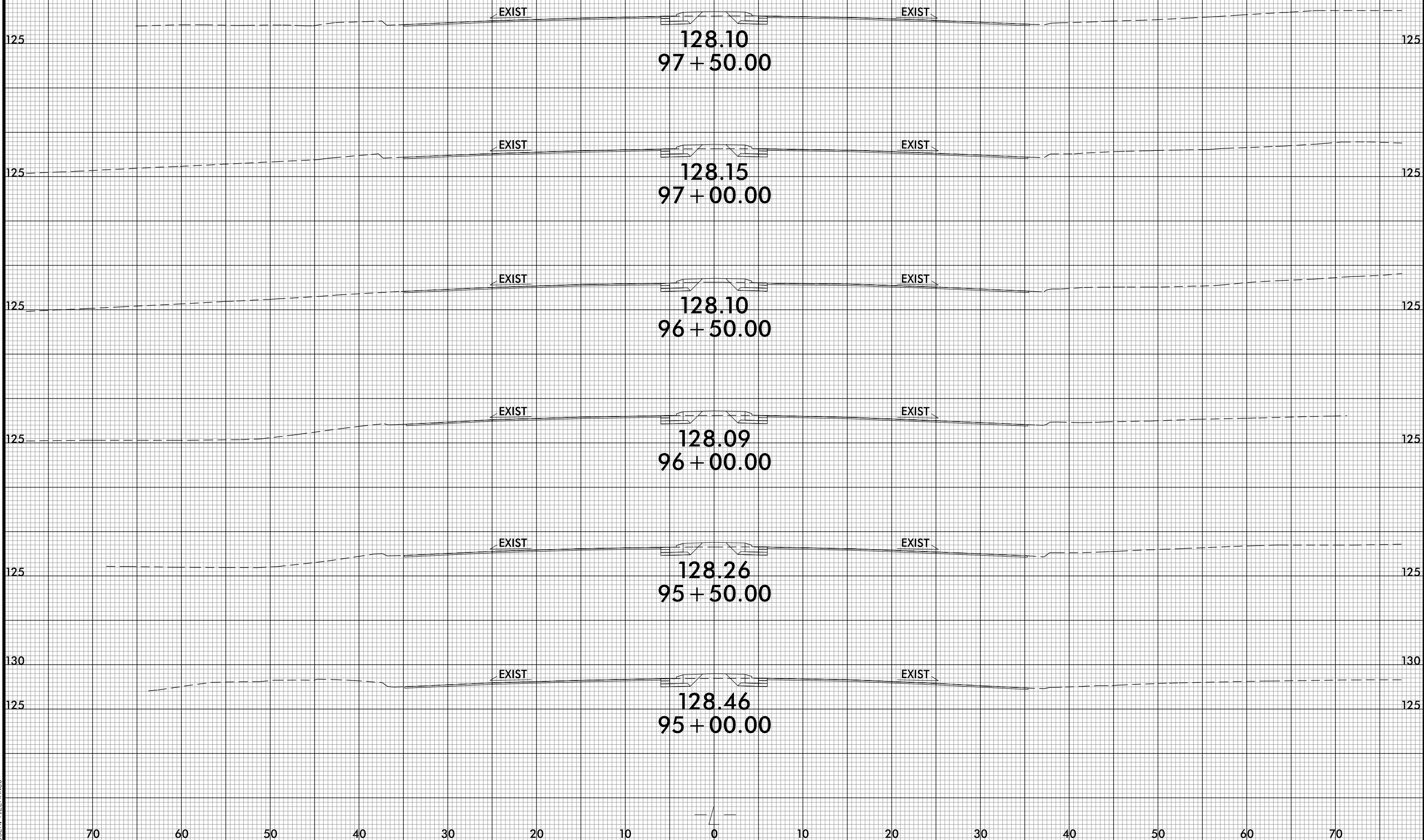

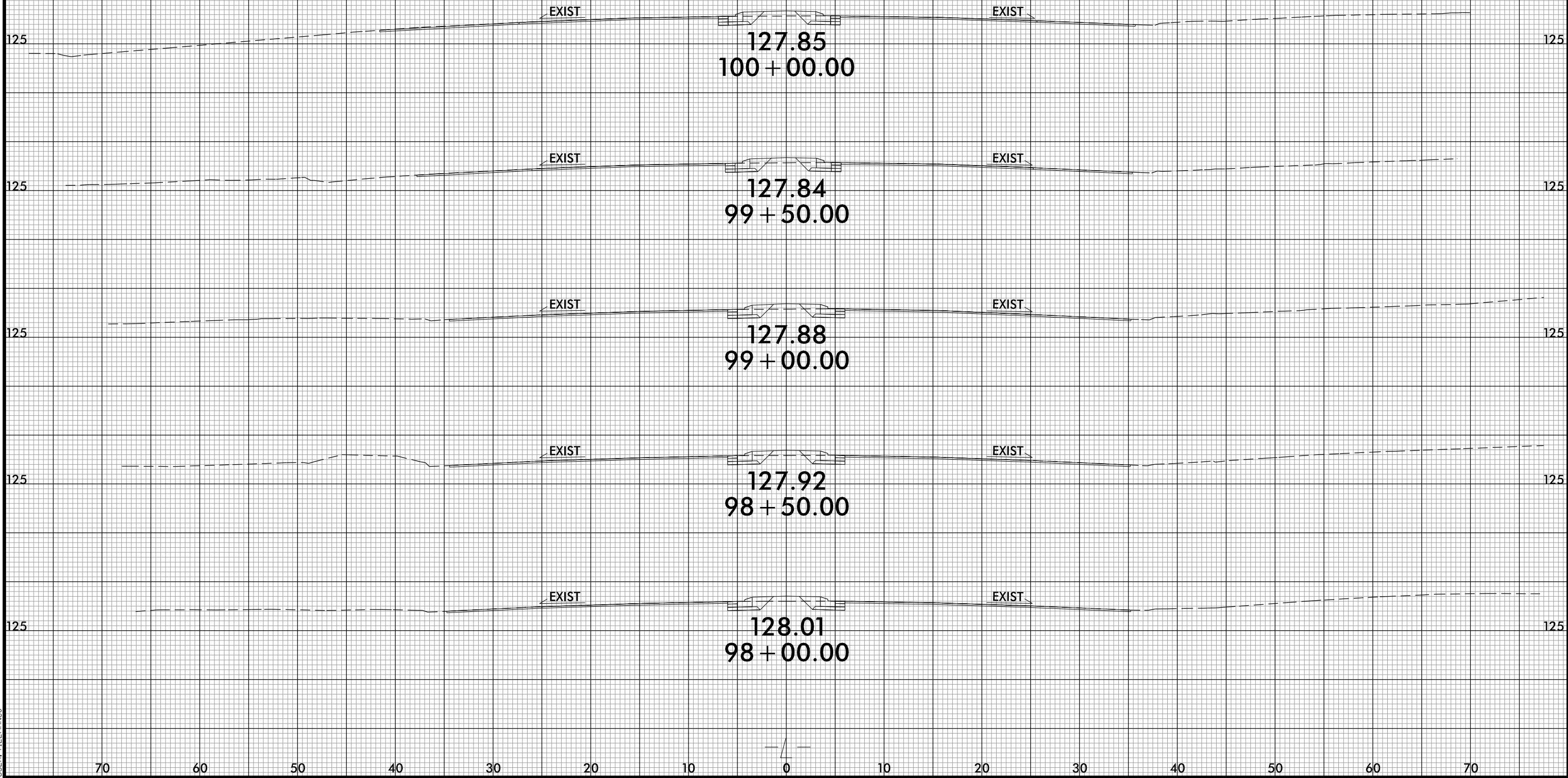

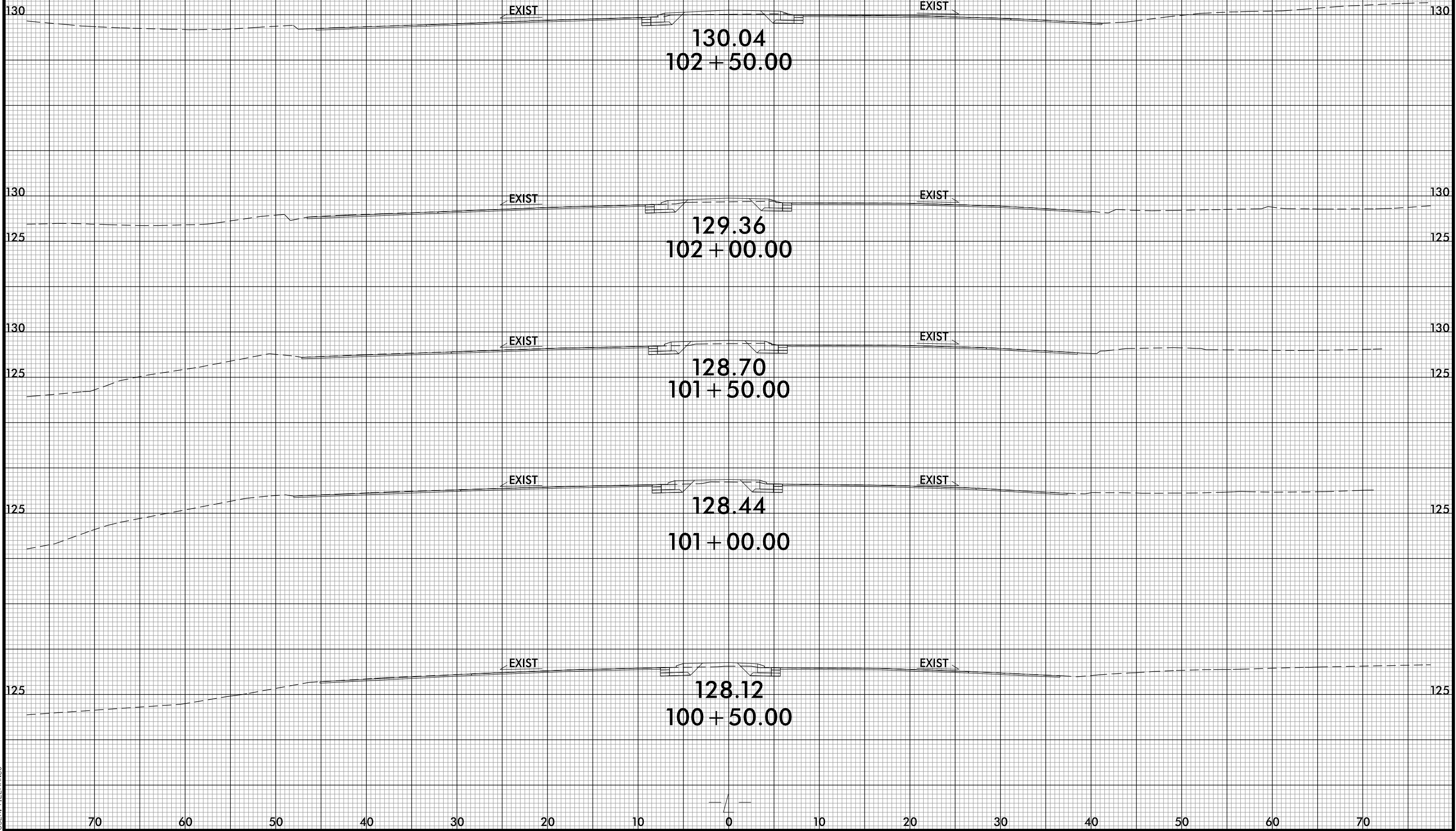

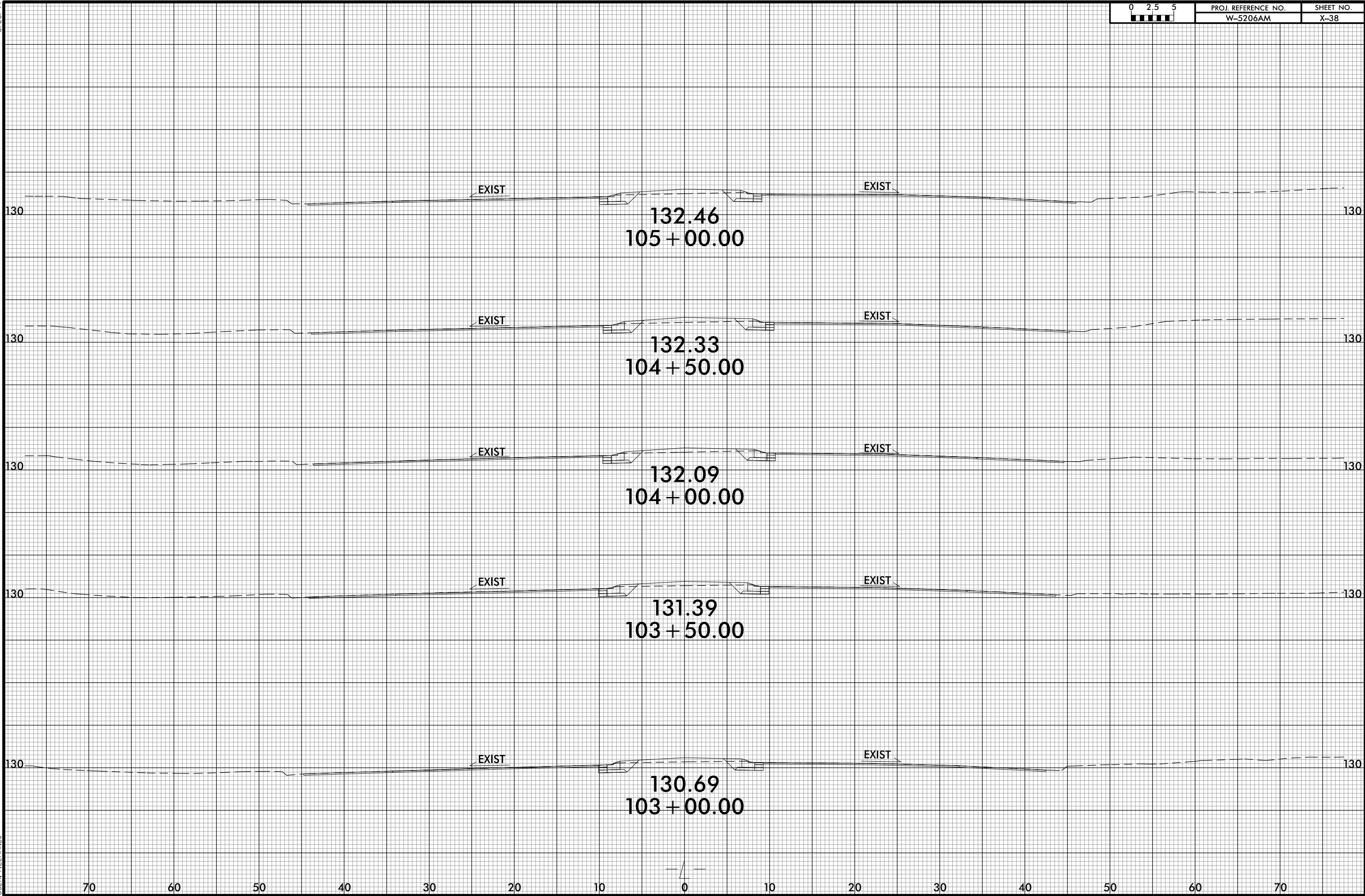

8/23/99



PROJ. REFERENCE NO.
W-5206AM

SHEET NO.
X-39

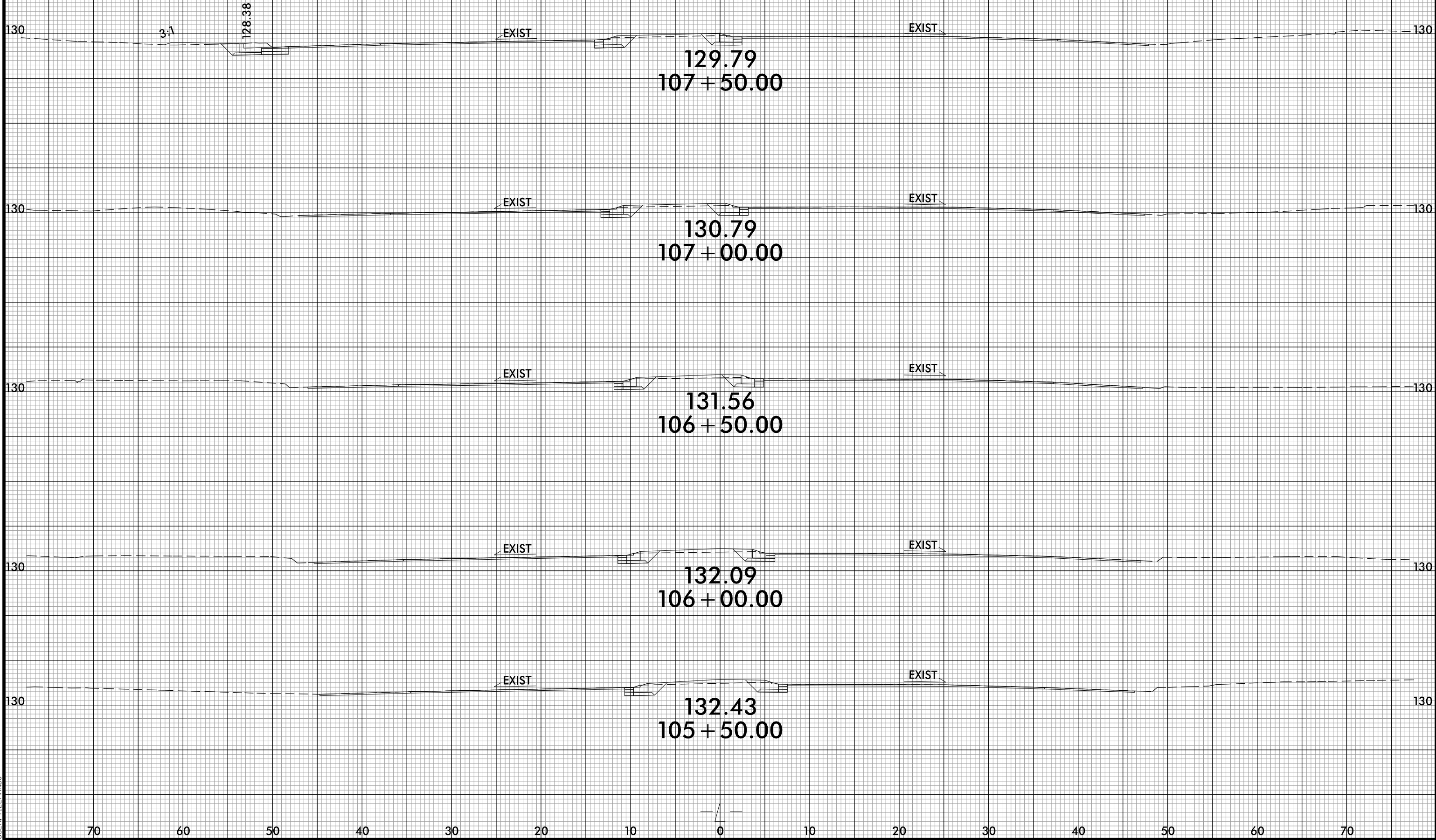

invalid expression
USER: \\W5206AM1.Pdu...xp1.br.agg.dgn

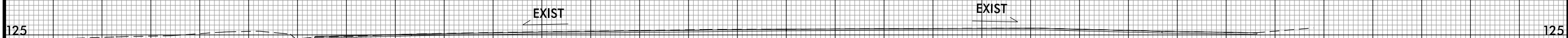

125.58
108 + 80.72



126.83
108 + 50.00

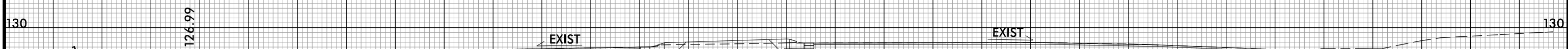

128.43
108 + 00.00

8/23/99



PROJ. REFERENCE NO.
W-5206AM

SHEET NO.
X-41

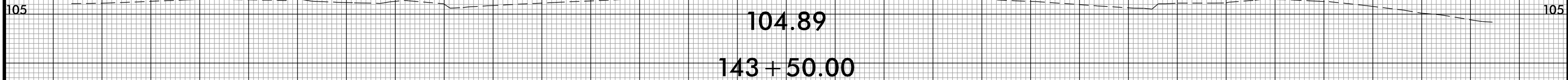
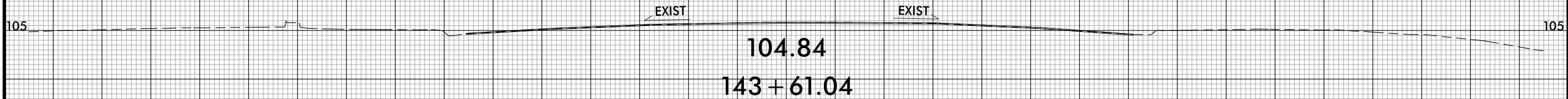
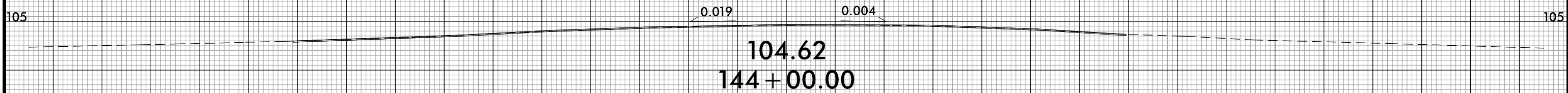
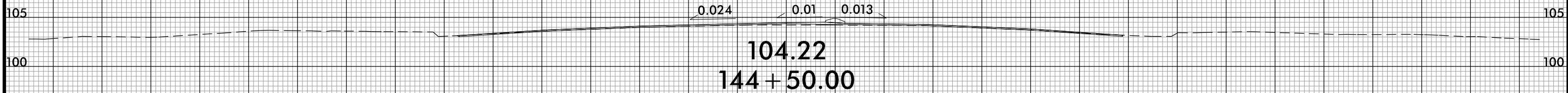
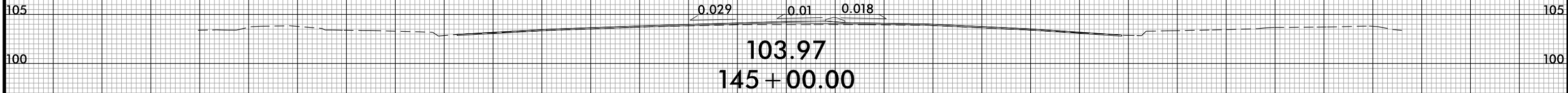

70 60 50 40 30 20 10 0 10 20 30 40 50 60 70

invalid expression
\\s:\w5206AM\1\pdu_xpl_rowan.dgn
USER: TLEMANCJ

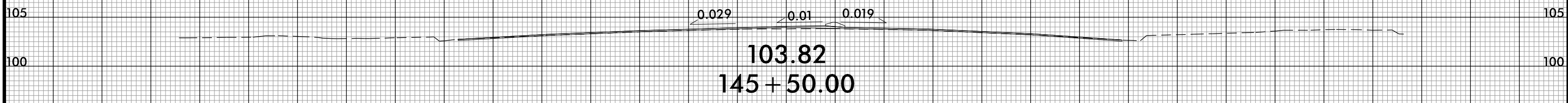
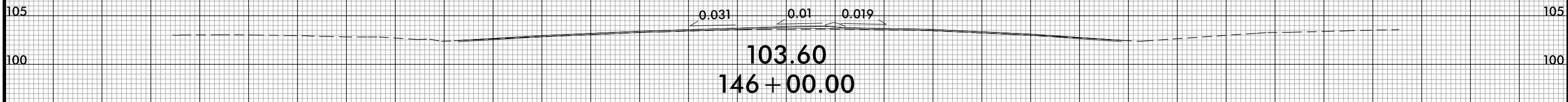
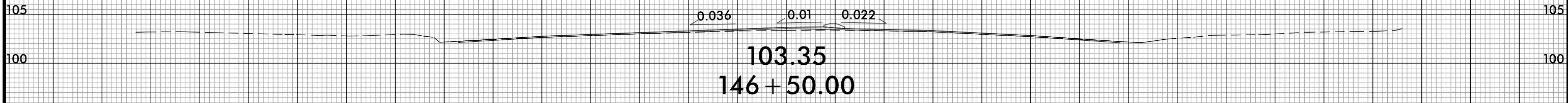
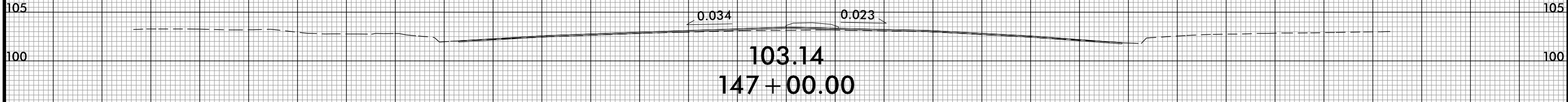
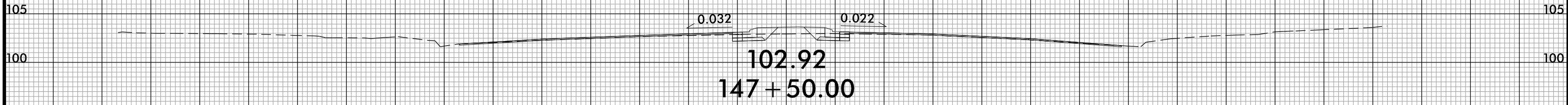

8/23/99



PROJ. REFERENCE NO.
W-5206AM

SHEET NO.
X-43

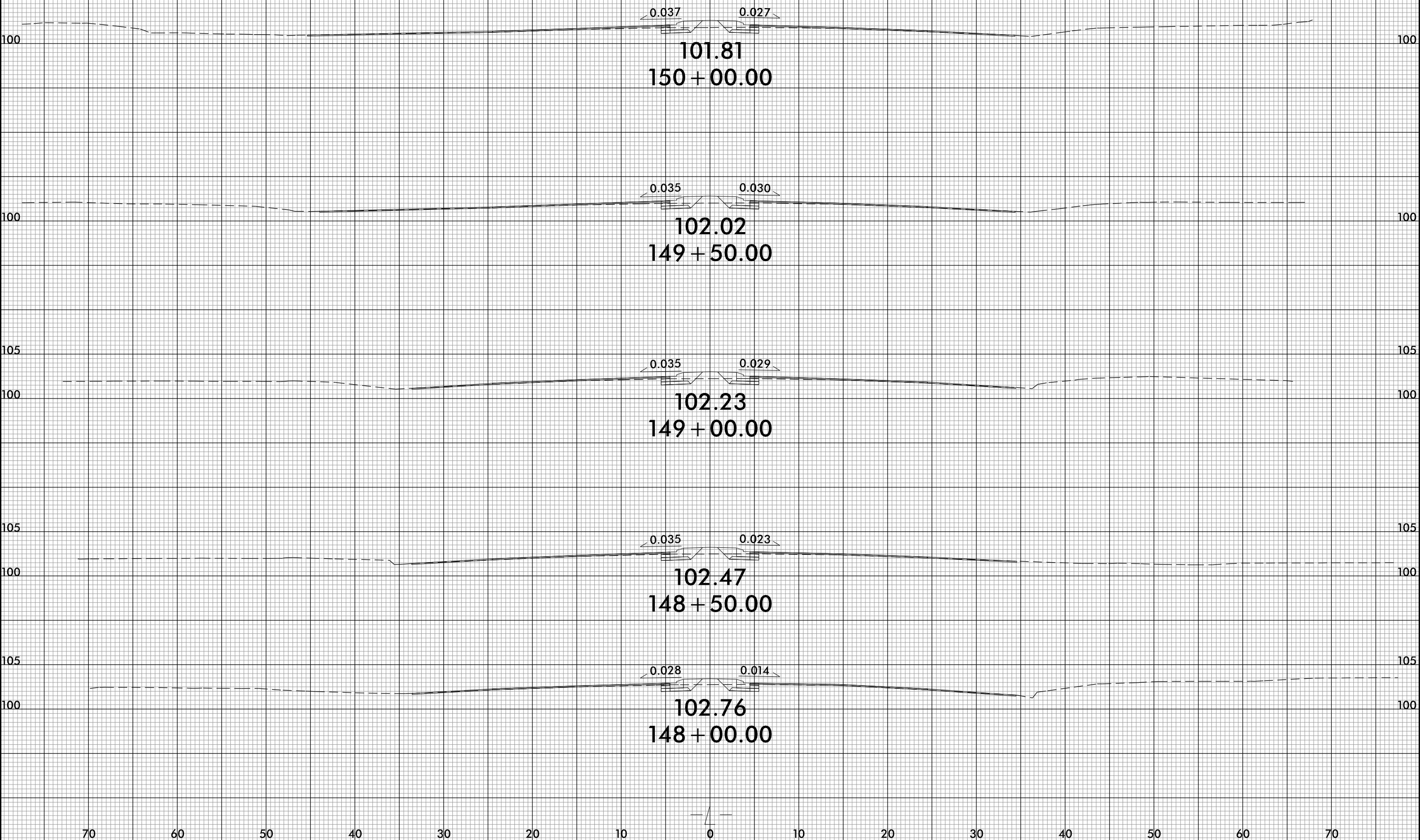

invalid expression
I:\S\5206AM\1.Rdy_xpl_rowan.dgn
USER: TLEWANG

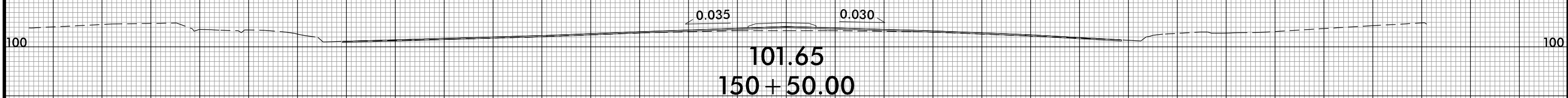
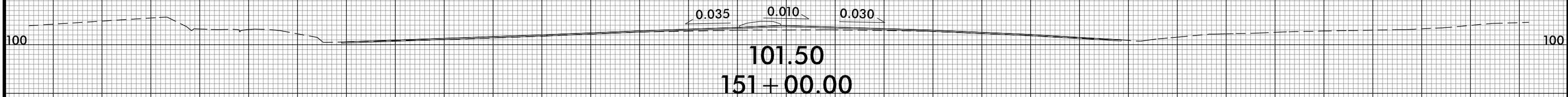
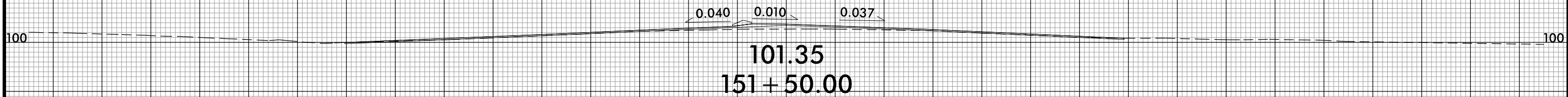
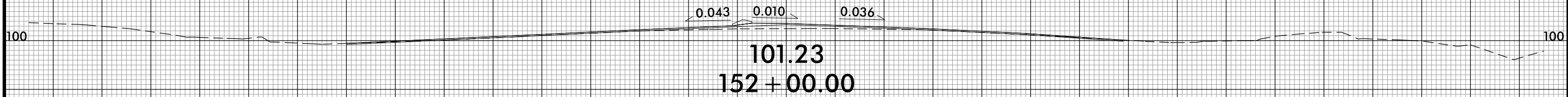

70 60 50 40 30 20 10 0 10 20 30 40 50 60 70

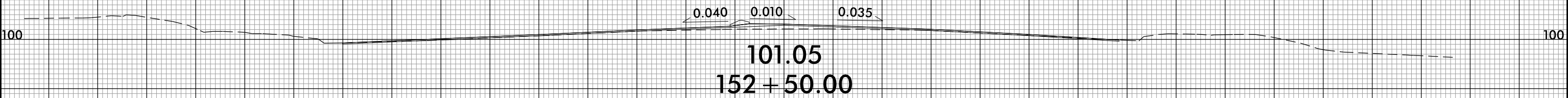
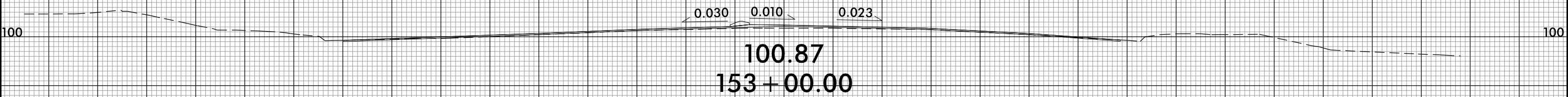
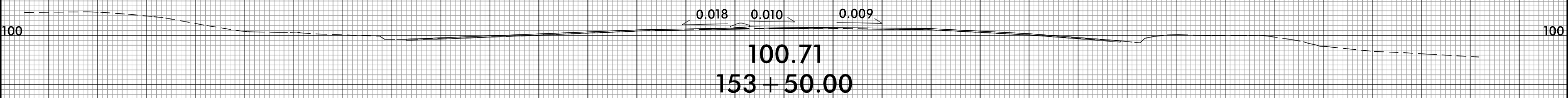
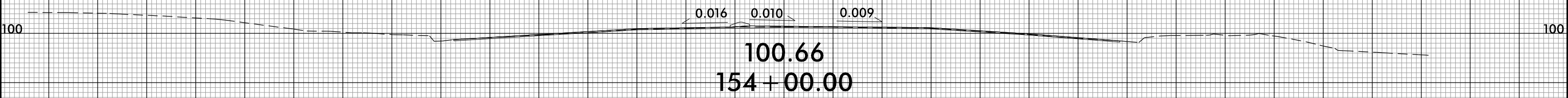

70 60 50 40 30 20 10 0 10 20 30 40 50 60 70

invalid expression
I:\S\5206AM\1.Rdy_xp1_rowan.dgn
USER: TLEWANG

8/23/99



PROJ. REFERENCE NO.
W-5206AM

SHEET NO.
X-46

100 100

101.31
155 + 00.00

100 100

101.33
154 + 90.00

100 100

101.01
154 + 50.00

100 100

100.76
154 + 25.04

0.011 0.010 0.002

70 60 50 40 30 20 10 0 10 20 30 40 50 60 70

invalid expression
USER: TLEMANCJ
I:\S\W5206AM\RDy_xpl_rowan.dgn

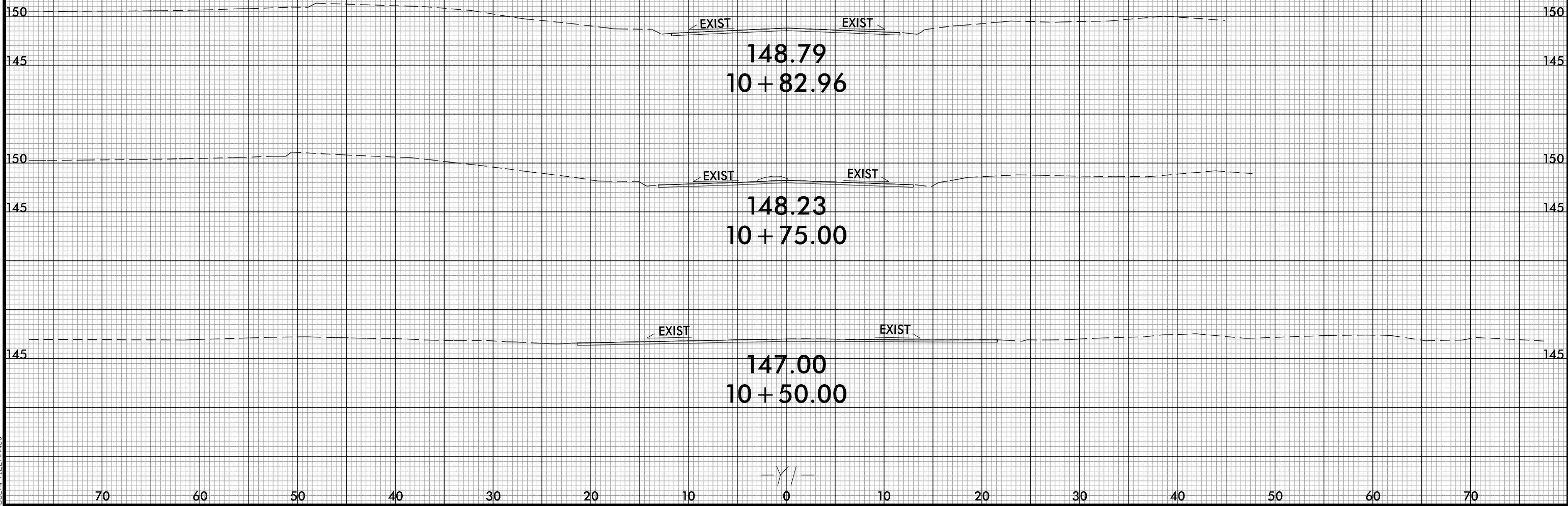

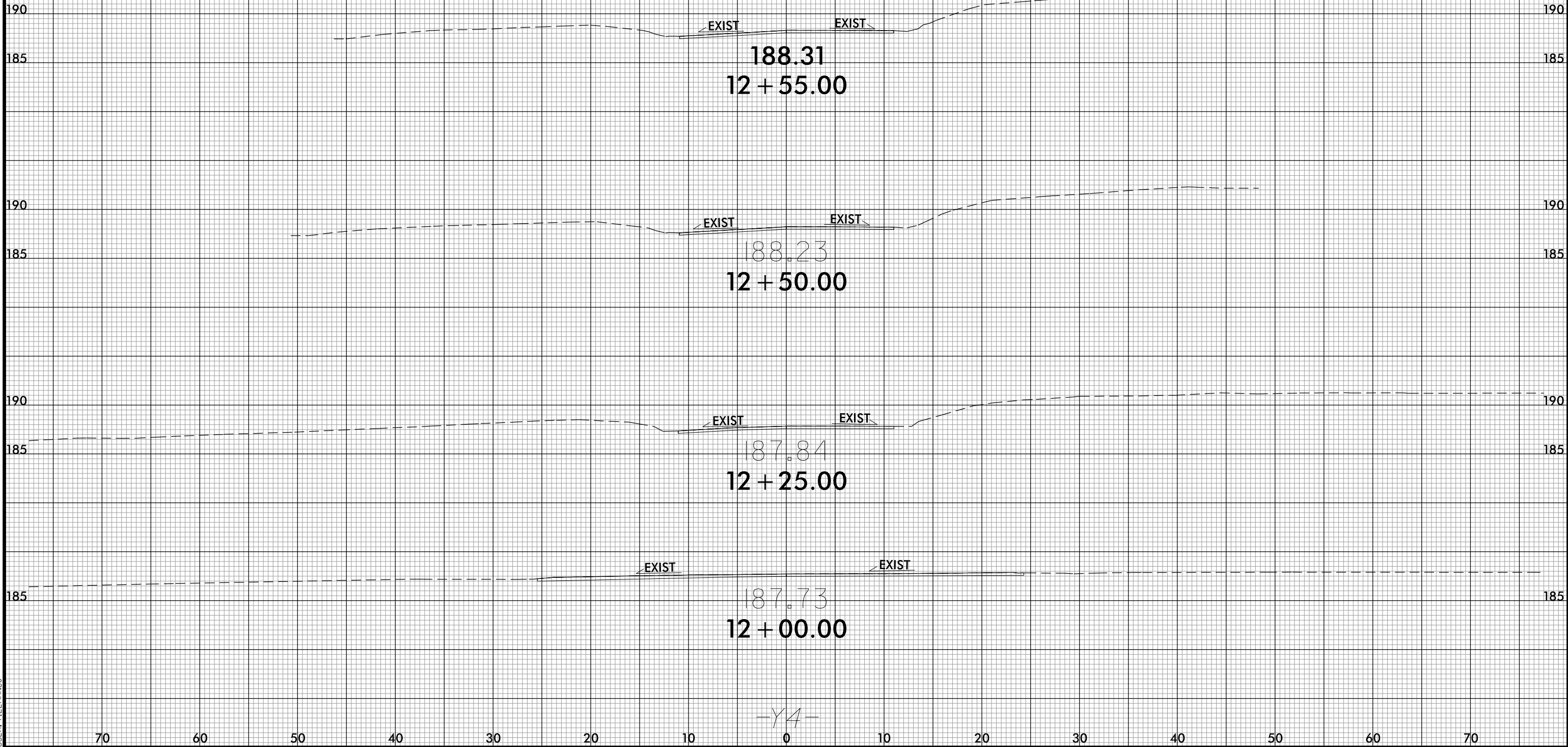

-L- CROSSING

188.44

11 + 75.00

-L- CROSSING

188.36

11 + 50.00

EXIST

EXIST

187.46

11 + 25.00

EXIST

EXIST

186.69

11 + 00.00

EXIST

EXIST

186.13

10 + 75.00

-Y4-

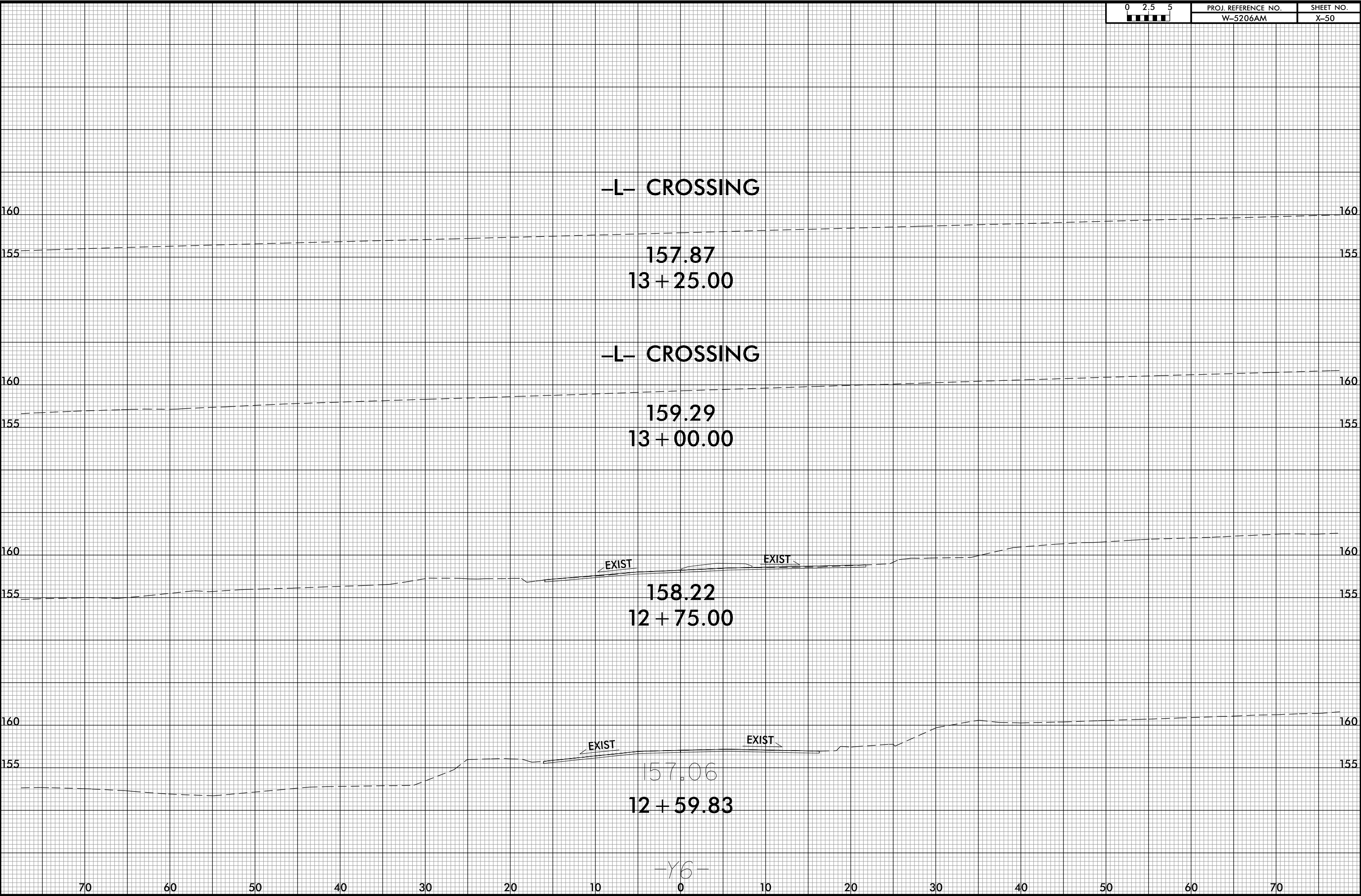

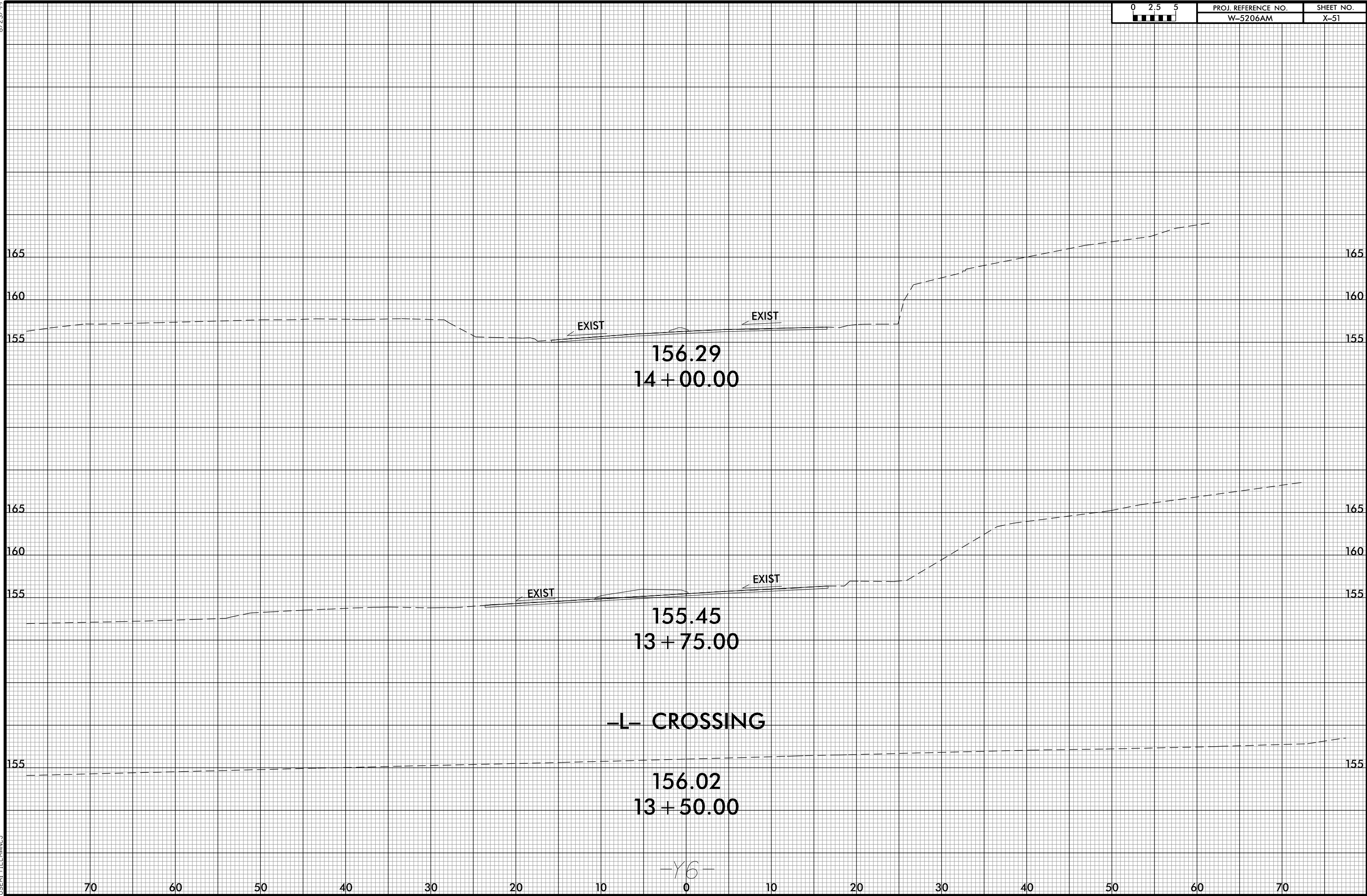

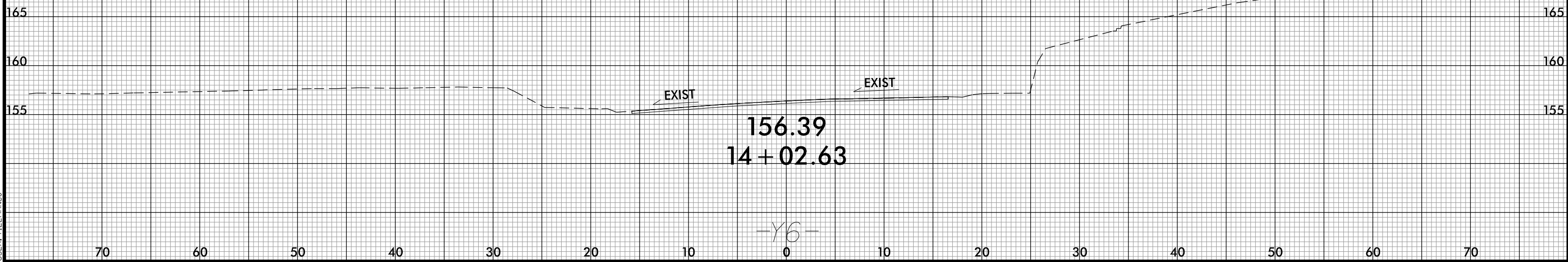

156.39
14+02.63

-Y6-



171.21
11 + 25.00



171.06
11 + 00.00

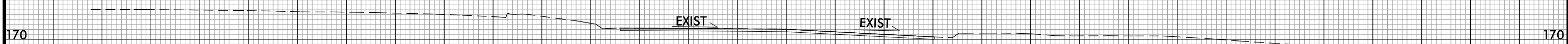

171.01
10 + 94.16

-Y8-



-L- CROSSING

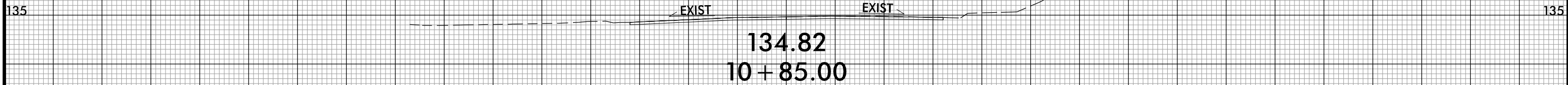
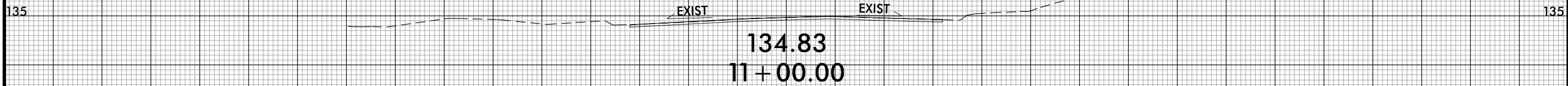
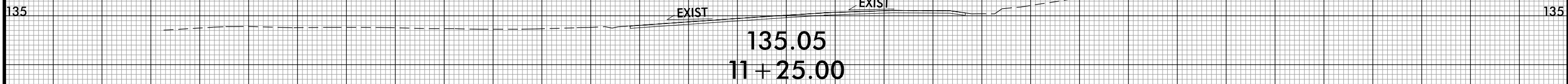
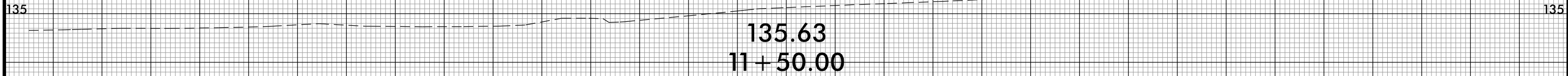

-Y9-

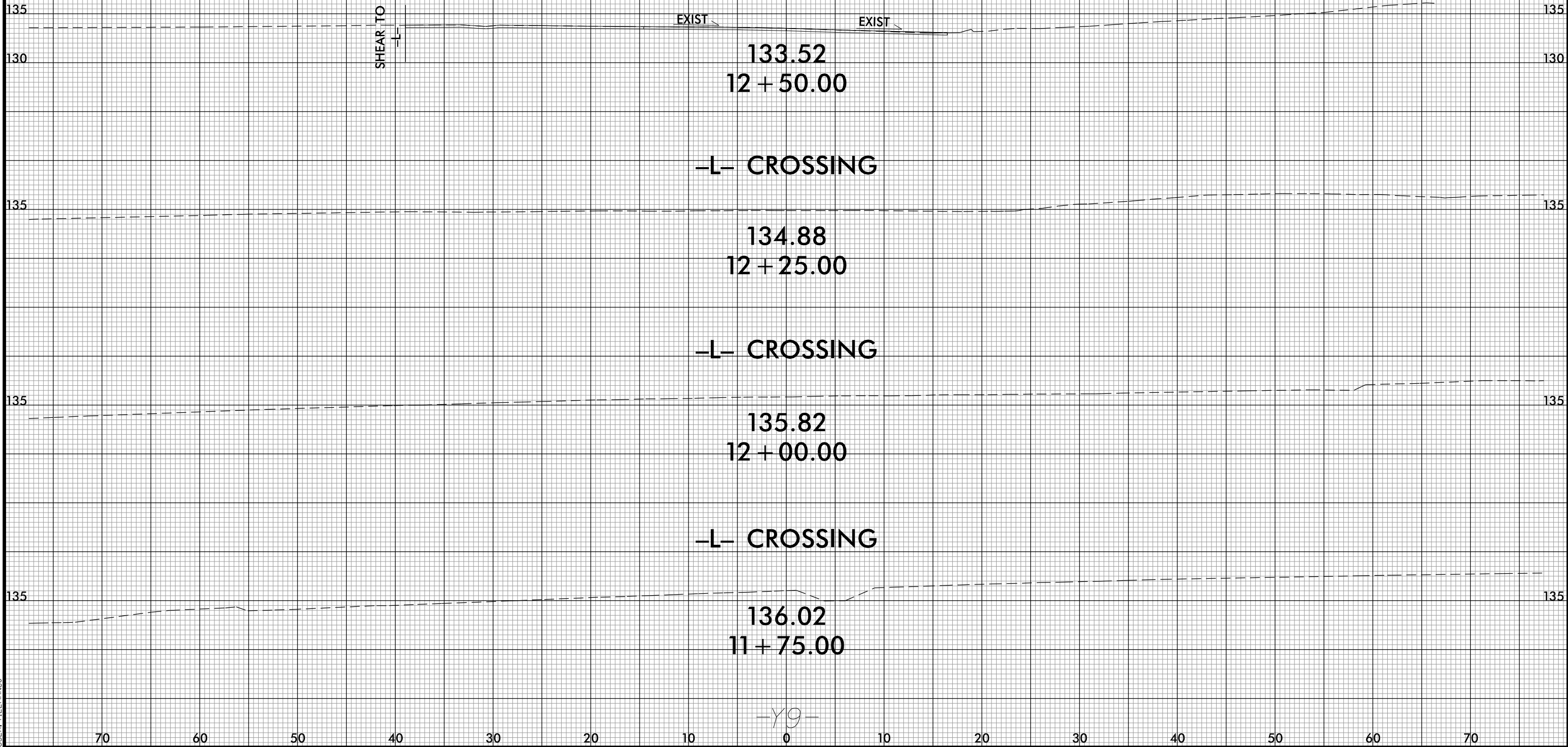

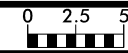

135 135

130 130

EXIST

EXIST

131.64
13 + 05.00

135 135

130 130

EXIST

EXIST

131.76
13 + 00.00

135 135

130 130

EXIST

EXIST

132.61
12 + 75.00

-Y9-

70

60

50

40

30

20

10

0

10

20

30

40

50

60

70