

ECONOLITE ASC/3 SPECIAL MMU PROGRAMMING

(program controller as shown below)

FROM MAIN MENU SELECT 1 (CONFIGURATION)

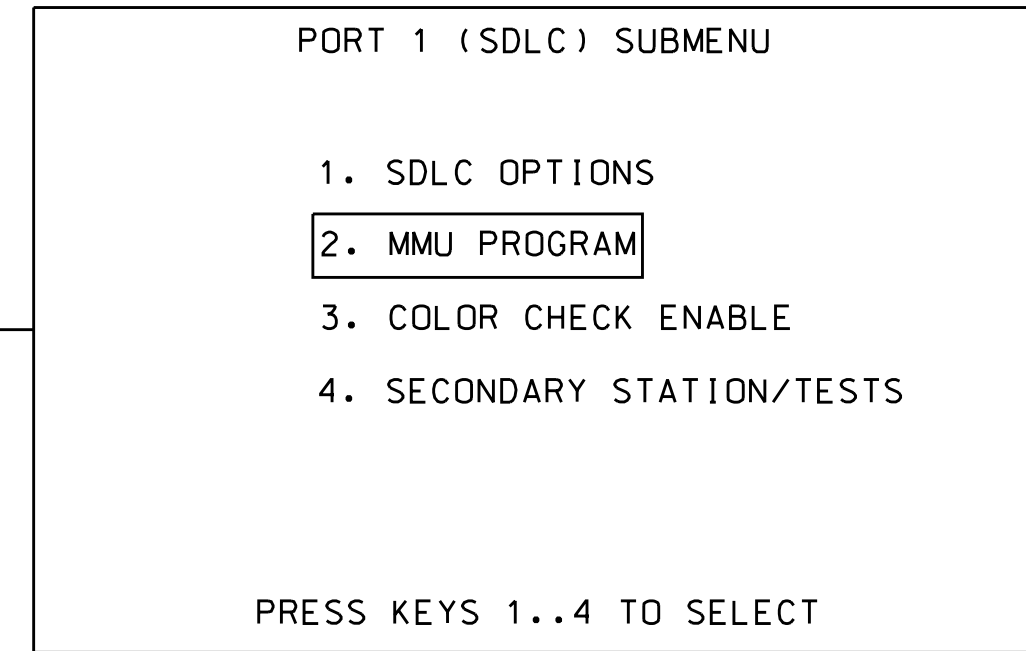
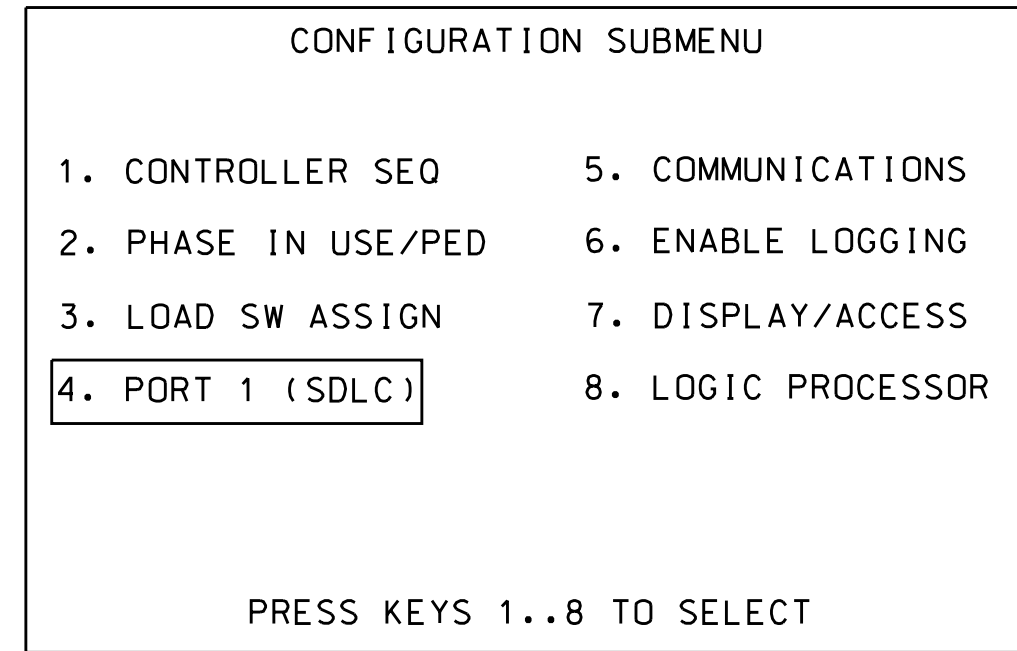

MMU PROGRAM [MANUAL]
CH	6 5 4 3 2 1 0 9 8 7 6 5 4 3 2
1	. X . X . X X X . . .
2	. X . X . X . X X X . . .
3
4 X . X
5	. X . X X
6	. X . X . X . X
7
8 X . X
9	. X . X . X
10 X
11	. X . X
12
13	. X
14

CAUTION!

Set intersection to Flash before attempting to enter or change any MMU programming data. This programming and that of the MMU programming card must match exactly. If they do not, the intersection will be placed into Flash.

4 SECTION FYA PPLT SIGNAL WIRING DETAIL

(wire signal heads as shown)

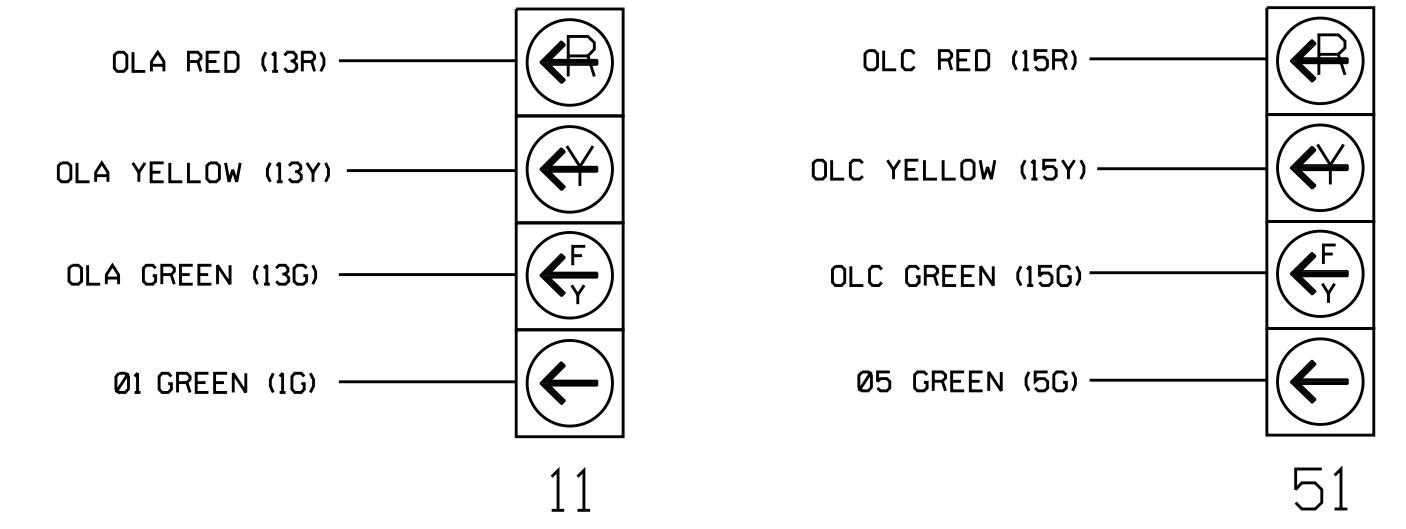

NOTE

1. SEE OVERLAP PROGRAMMING INSTRUCTIONS THIS SHEET.

ECONOLITE ASC/3 OVERLAP PROGRAMMING DETAIL

(program controller as shown)

From Main Menu select 2 (CONTROLLER)

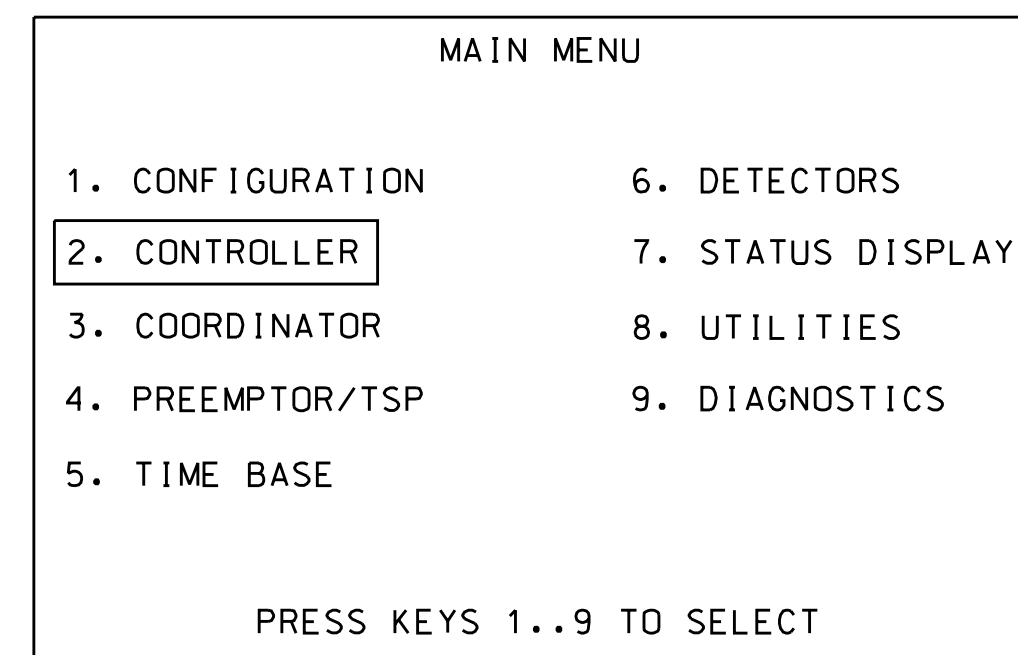

From Controller Sub select 2 (VEHICLE OVERLAPS)

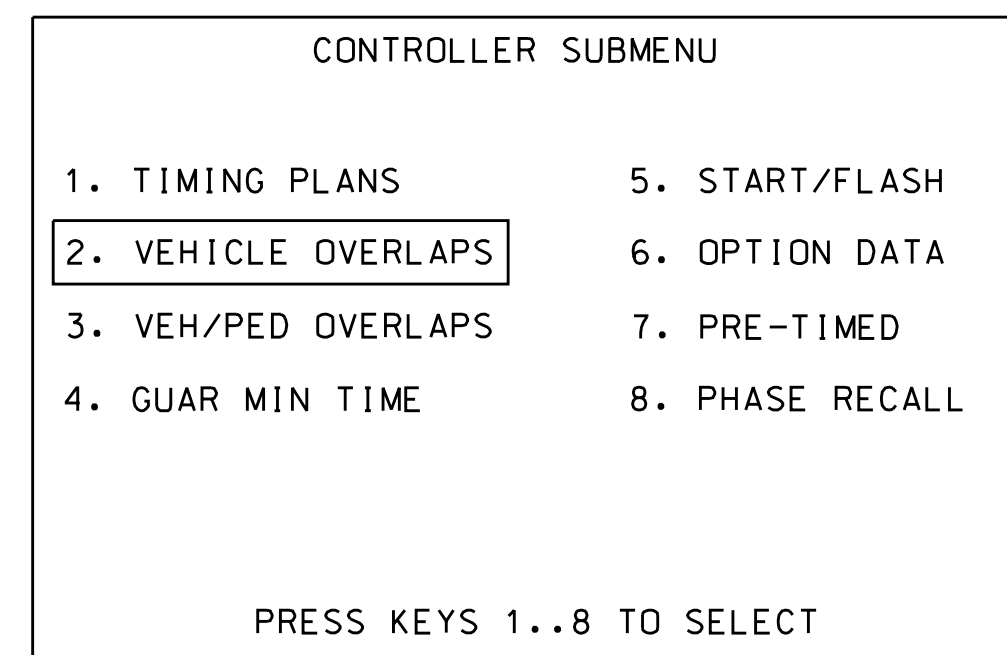

OVERLAP A

Select Vehicle Overlap Type (PPLT FYA)

TMG VEH OVLP . . . [A] TYPE: PPLT FYA

PROTECTED PHASE (LEFT TURN).....1
 PERMISSIVE PHASE (OPPOSING THRU).....2
 FLASHING ARROW OUTPUT.....CH13 ISOLATE
 DELAY START OF: FYA.. 0.0 CLEARANCE.....0.0
 ACTION PLAN SF BIT DISABLE.....0.0

OVERLAP C

Select Vehicle Overlap Type (PPLT FYA)

TMG VEH OVLP . . . [C] TYPE: PPLT FYA

PROTECTED PHASE (LEFT TURN).....5
 PERMISSIVE PHASE (OPPOSING THRU).....6
 FLASHING ARROW OUTPUT.....CH15 ISOLATE
 DELAY START OF: FYA.. 0.0 CLEARANCE.....0.0
 ACTION PLAN SF BIT DISABLE.....0.0

PEDESTRIAN PUSH-BUTTON WIRING DETAIL

(wire push-buttons as shown below)

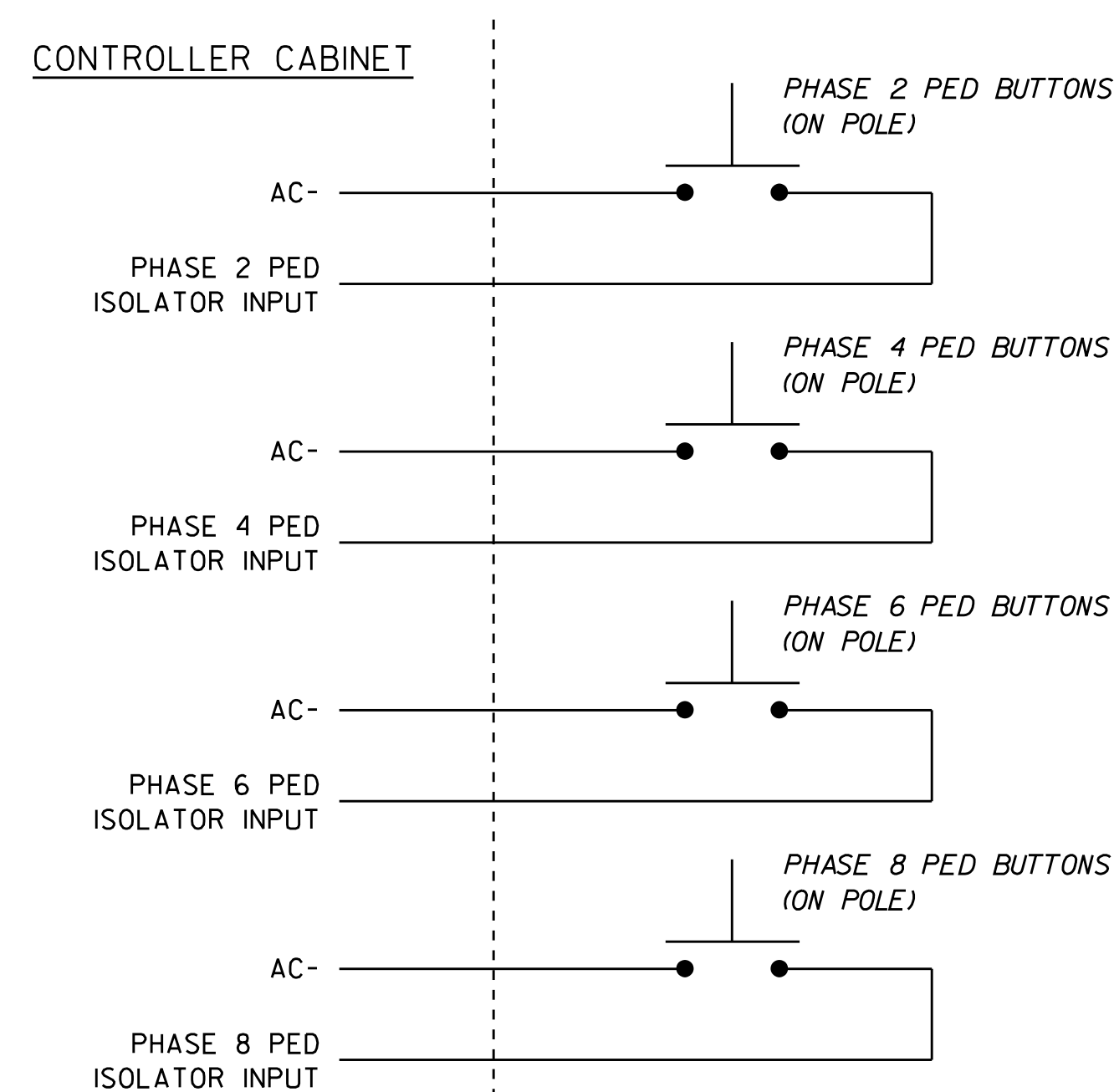

LOAD RESISTOR INSTALLATION DETAIL

(install resistors as shown below)

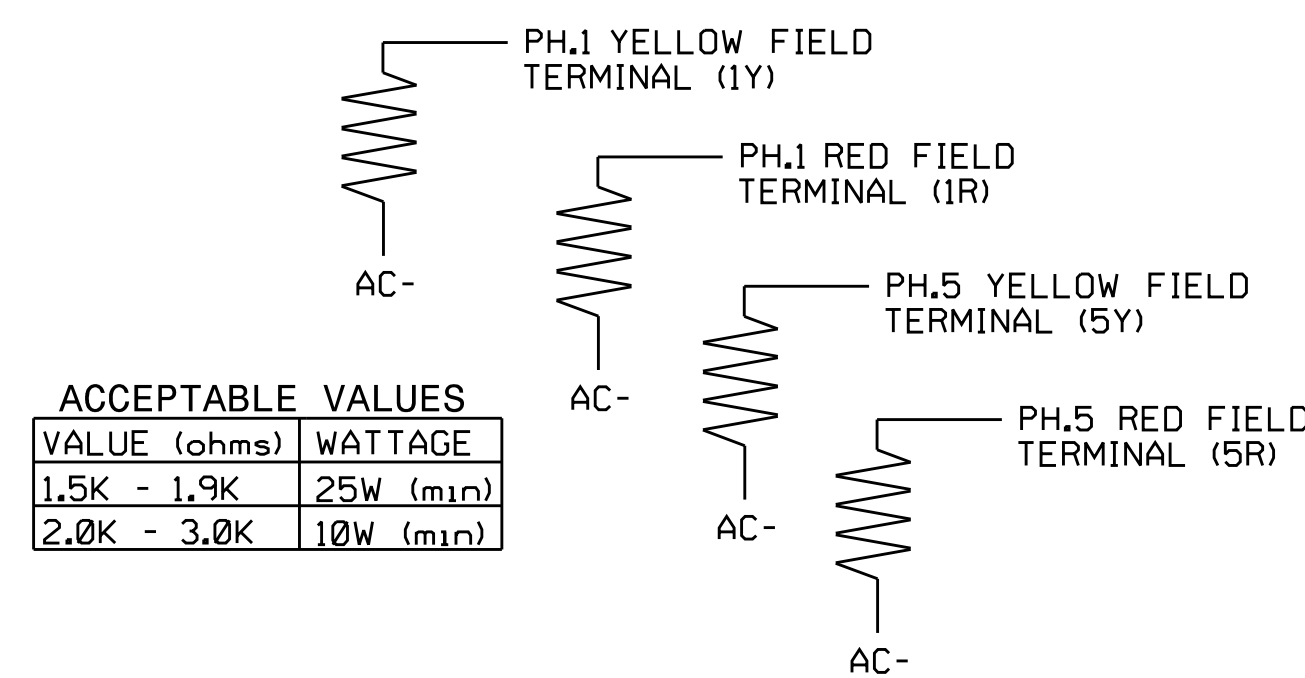

THIS ELECTRICAL DETAIL IS FOR THE SIGNAL DESIGN: 02-0892T3
 DESIGNED: JUNE 2014
 SEALED: 9/2/2014
 REVISED: N/A

TEMPORARY DESIGN 3-TMP PHASE 3 DESIGN SHEET 2 OF 2

	10th STREET AT BANCROFT AVENUE/ LINE AVENUE		SEAL
	DIVISION 2 PLAN DATE: JUNE 2014 PREPARED BY: SP PENNINGTON	PITT COUNTY REVIEWED BY: SL PHILLIPS REVIEWED BY:	

PLANS PREPARED IN THE OFFICE OF:
Kimley»Horn
 NC License #F-0102
 P.O. Box 33068
 Raleigh, NC 27636
 (919) 677-2000

DocuSigned by:
 Stacie Phillips 9/2/2014

SIG. INVENTORY NO. 02-0892T3

K:\RAL_Roadway\01036175 (U-3315) \Traffic Signal\sk4 - Signal Design\2-G-091 Bancroft\2-G-091 Bancroft\1-2.dgn
 8/29/2014 1:17:17 PM susan.pennington