

SEE SHEET S-1 TO S-31 FOR STRUCTURE DESIGN PLANS  
SEE SHEET 5 FOR PROFILE OF -L-

**NAD 83/NSRS 2007**

PI Sta 15+92.97 Δ = 13° 30' 44.2" (LT) D = 3° 57' 05.2" L = 341.96' T = 171.78' R = 1,450.00'	PI Sta 25+06.16 Δ = 5° 11' 27.5" (LT) D = 1° 54' 35.5" L = 271.80' T = 135.99' R = 3,000.00'	PI Sta 29+70.93 Δ = 16° 29' 14.8" (LT) D = 4° 05' 33.2" L = 402.86' T = 202.83' R = 1,400.00'
--	---	--

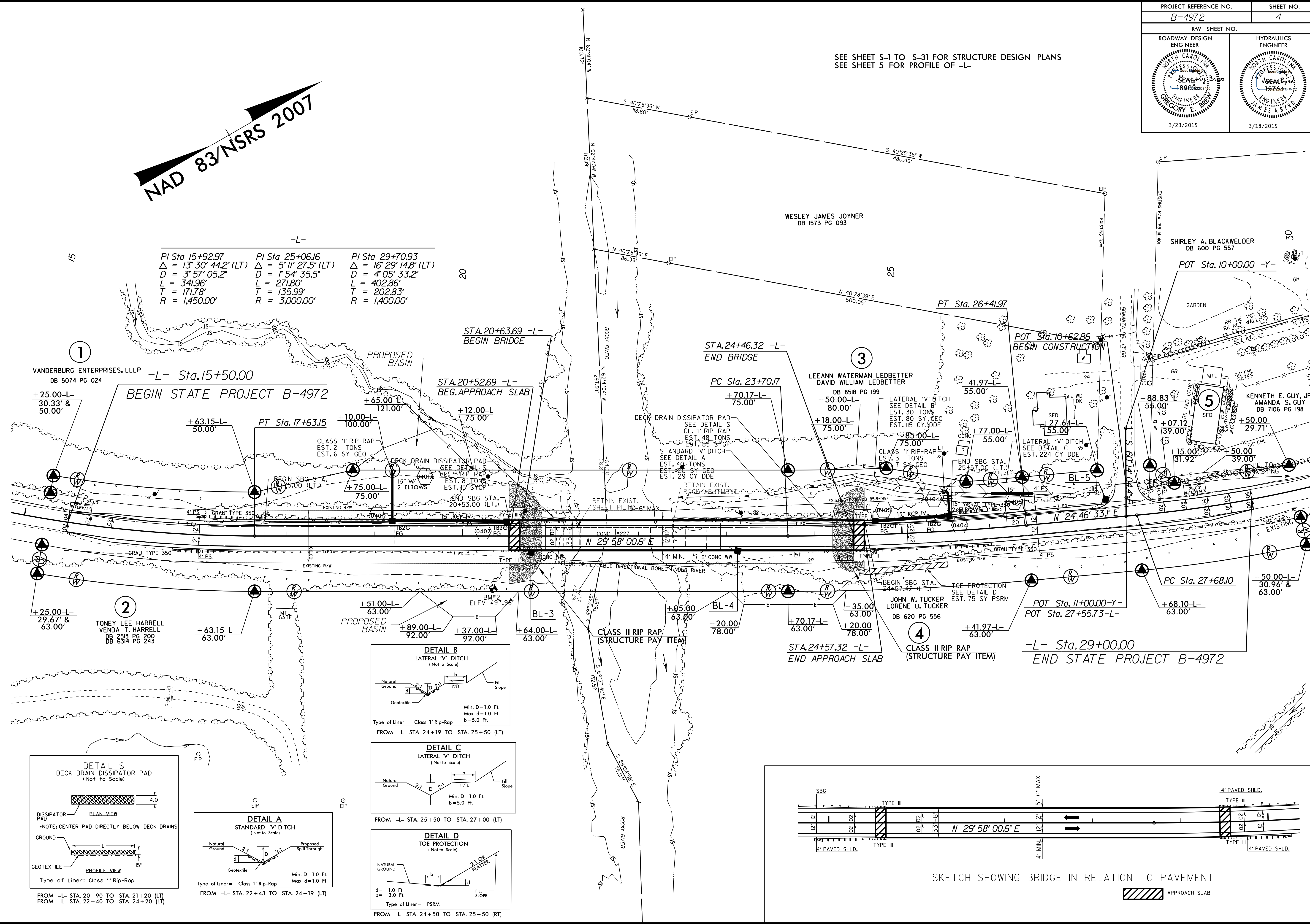

1  
VANDERBURG ENTERPRISES, LLLP  
DB 5074 PG 024  
-L- Sta. 15+50.00  
**BEGIN STATE PROJECT B-4972**

2  
TONEY LEE HARRELL  
VENDA T. HARRELL  
DB 2513 PG 209  
DB 6314 PG 243

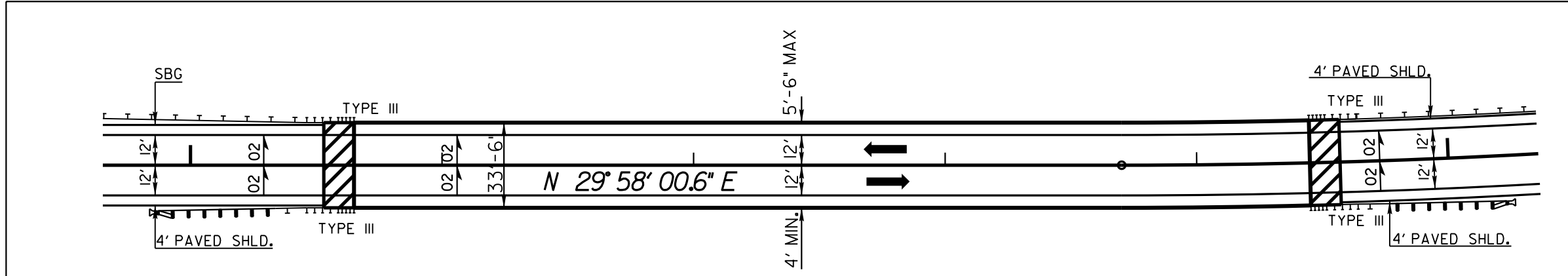
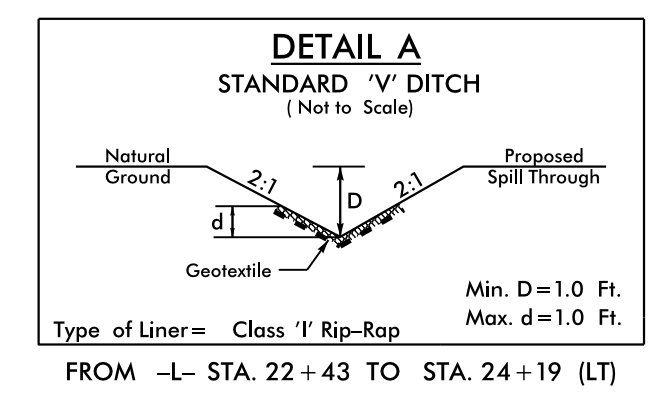
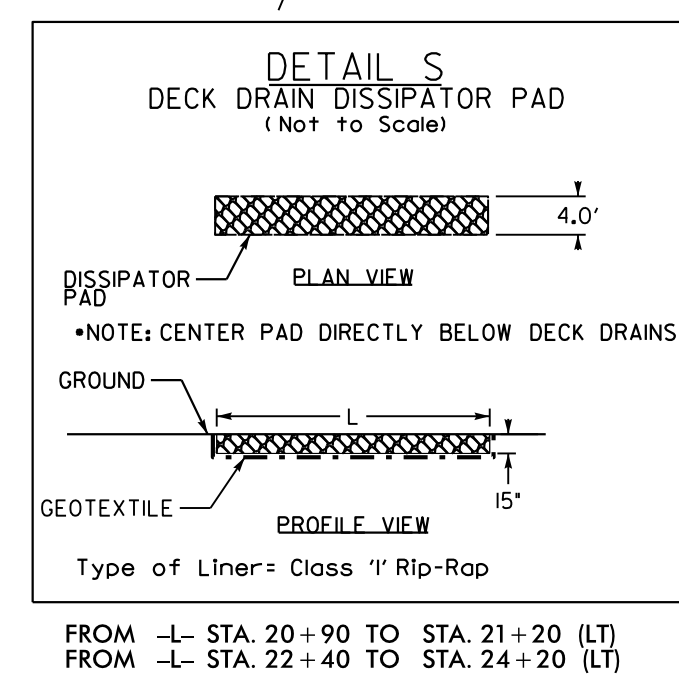
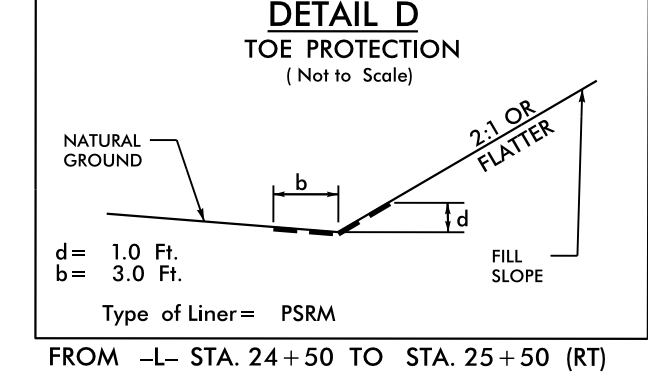
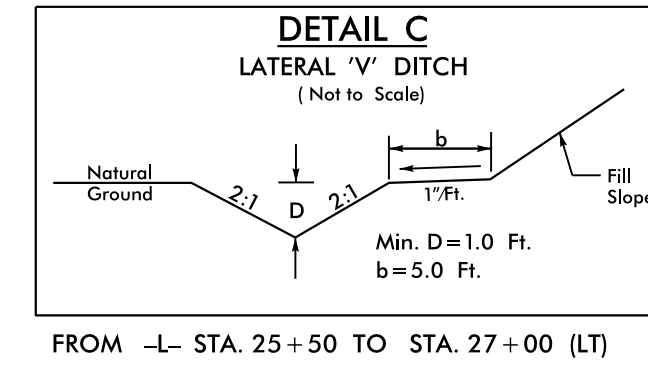
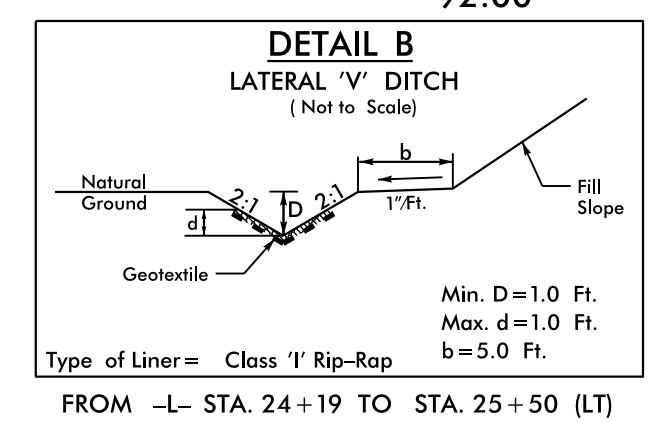

REVISIONS

8/17/99

18-MAR-2015 10:02 AM B-4972\_rdl\_psh.dgn  
3:58:52 PM