



SUMMARY OF QUANTITIES FOR SPAN'S "C" AND "D"

	SPAN "C"		SPAN "D"	
	ESTIMATE	ACTUAL	ESTIMATE	ACTUAL
SCARIFYING BRIDGE DECK	176.0 SY		176.0 SY	
HYDRO-DEMOLITION OF BRIDGE DECK	176.0 SY		176.0 SY	
CLASS II SURFACE PREPARATION	1.8 SY		1.8 SY	
CLASS III SURFACE PREPARATION	0.0 SY		0.0 SY	
JOINT DEMOLITION	32.7 SF		16.3 SF	

PAYMENT FOR CLASS II AND CLASS III SURFACE PREP. BASED UPON SQUARE FEET OF ADDITIONAL DEMOLITION REQUIRED FOLLOWING HYDRO-DEMOLITION OF BRIDGE DECK, SEE "OVERLAY SURFACE PREPARATION" SPECIAL PROVISION.

THE EXISTING BRIDGE SURFACE HAS AN ASPHALT WEARING SURFACE. IT IS POSSIBLE THAT CLASS II SURFACE PREPARATION MIGHT BE NECESSARY, BUT CANNOT BE ESTIMATED WITH THE AWS PRESENT. THE QUANTITY INDICATED IS FOR BIDDING PURPOSES ONLY. THE ACTUAL QUANTITY SHALL BE CONFIRMED AFTER SCARIFICATION AND HYDRO-DEMOLITION OF THE BRIDGE DECK.

-  SCARIFYING BRIDGE DECK
-  APPROX. AREA CLASS II SURFACE PREPARATION
-  BRIDGE JOINT DEMOLITION

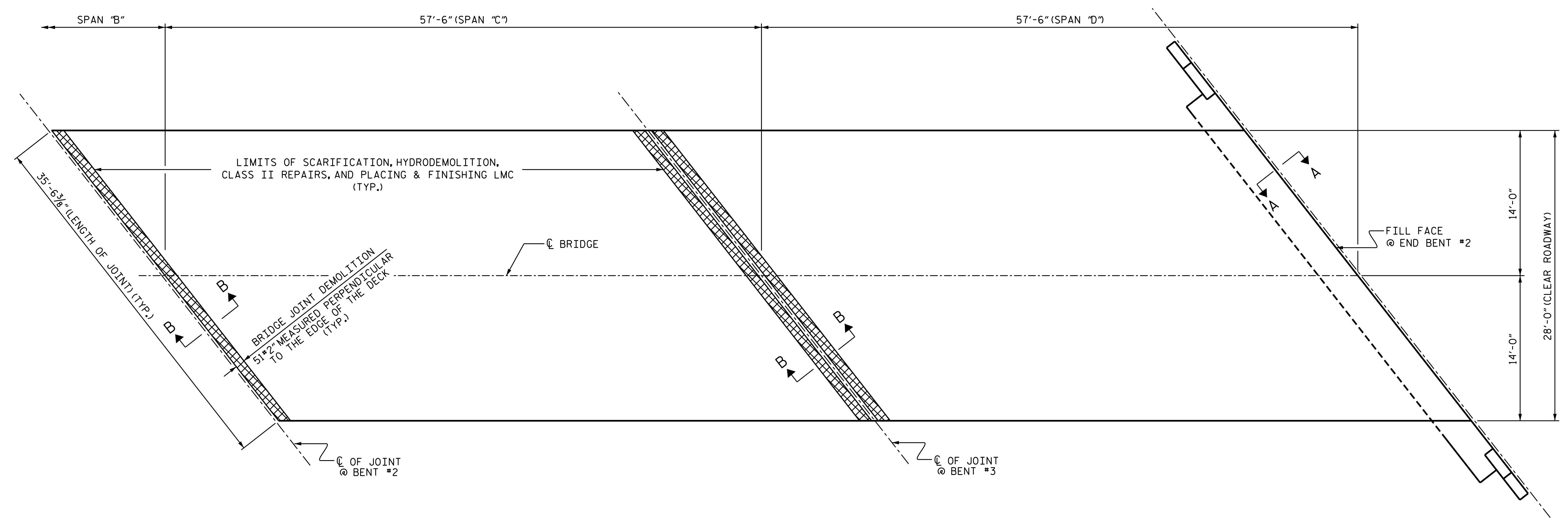

PLAN OF SPAN "C" AND "D"

(SEE "JOINT DETAILS" SHEET FOR SECTIONS A-A AND B-B)

PROJECT NO. I-5308
ROBESON COUNTY
 BRIDGE NO.: 145

STATE OF NORTH CAROLINA
 DEPARTMENT OF TRANSPORTATION
 RALEIGH

SURFACE PREPARATION
 SPANS "C" AND "D"

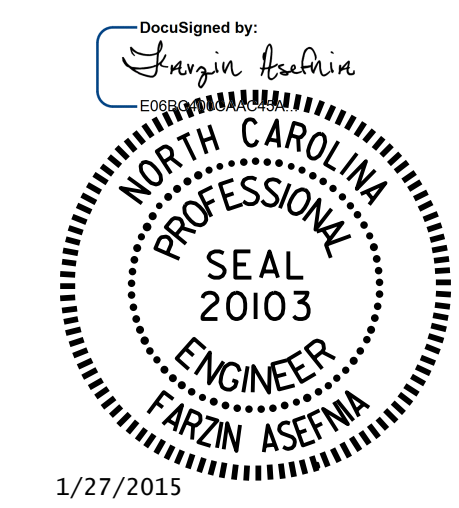

DRAWN BY : D.V. JOYNER DATE : 11/2014
 CHECKED BY : F. ASEFNIA DATE : 11/2014

REVISIONS						SHEET NO.
NO.	BY:	DATE:	NO.	BY:	DATE:	S-8
1			3			TOTAL SHEETS
2			4			23