

T.I.P.: R-2303C

CONTRACT:

**STATE OF NORTH CAROLINA  
DEPARTMENT OF TRANSPORTATION**

**SIGNING PLAN  
SAMPSON COUNTY**

**LOCATION: NC 24 FROM SR 1404 (DOWDY ROAD) TO SR 1303  
(MITCHELL LOOP ROAD)**

TIP NO. R-2303C	SHEET NO. SIGN-1
APPROVED:	
DATE: 2-16-13	
SEAL	

**ROADWAY STANDARD DRAWING**

THE FOLLOWING ROADWAY STANDARDS AS APPEAR IN "ROADWAY STANDARD DRAWINGS" - PROJECT SERVICES UNIT - N.C. DEPARTMENT OF TRANSPORTATION - RALEIGH, N.C., DATED JANUARY 2012 ARE APPLICABLE TO THIS PROJECT AND BY REFERENCE HEREBY ARE CONSIDERED A PART OF THESE PLANS:

STD. NO.	TITLE
901.10	TYPE 'A' SIGNS
901.20	TYPE 'B' SIGNS
901.50	ARROWS AND SHIELDS
901.70	SIGN STRINGERS AND SUPPORT SPACING
901.80	SIGN MOUNTING DETAILS - FOR TYPE A AND TYPE B SIGNS
903.10	GROUND MOUNTED SIGN SUPPORTS
904.10	ORIENTATION OF GROUND MOUNTED SIGNS
904.50	MOUNTING OF TYPE 'D', 'E' AND 'F' SIGNS ON 'U' CHANNEL POSTS

**PROJECT NOTES**

- 1 DISPOSAL OF SIGN SYSTEM, U-CHANNEL

**GENERAL NOTES**

- . SIGNS FURNISHED BY STATE
- . ALL TYPE 'D' SIGNS SHALL BE MOUNTED ON TWO U-CHANNEL POSTS UNLESS OTHERWISE INDICATED ON THE PLANS.
- . IF REMOVAL OR RELOCATION OF SIGNS ON PRIVATE STREET (NON-STATE MAINTAINED) IS REQUIRED DUE TO CONSTRUCTION, THE CONTRACTOR SHALL INFORM THE ENGINEER. THE WORK WILL BE COMPLETED BY OTHERS.
- . WHEN NOT STATIONED OR DIMENSIONED ON PLANS, ALL 'E' AND 'F' SIGNS SHALL BE FIELD LOCATED BY THE ENGINEER
- . ALL EXISTING SIGNS ON "U" CHANNEL POST WITHIN THE PROJECT LIMITS SHALL BE REMOVED AND DISPOSED OF UNLESS OTHERWISE NOTED ON PLANS.
- . WHEN EXISTING SIGNS ARE REMOVED AND INSTALLED ON NEW SUPPORTS, THE RE-ERECTION SHALL IMMEDIATELY FOLLOW THE REMOVAL.
- . THE BACKGROUND FOR TYPE E & F SIGNS SHALL BE TYPE C REFLECTIVE SHEETING.
- . SEE ROADWAY PLANS FOR GUARD/GUIDE RAIL DETAILS.

**SUMMARY OF QUANTITIES**

ITEM NO.		ITEM DESCRIPTION	QUANTITY	UNIT
DESC. NO.	SECT. NO.			
4048000000	902	REINFORCED CONCRETE SIGN FOUNDATION	1	C.Y.
4060000000	903	SUPPORTS, BREAKAWAY STEEL BEAM	573	LB.
4072000000	903	SUPPORTS, 3 LB STEEL U-CHANNEL	5221	L.F.
4096000000	904	SIGN ERECTION, TYPE D	22	EA.
4102000000	904	SIGN ERECTION, TYPE E	177	EA.
4108000000	904	SIGN ERECTION, TYPE F	72	EA.
4110000000	904	SIGN ERECTION, TYPE B (GROUND MOUNTED)	1	EA.
4155000000	907	DISPOSAL OF SIGN SYSTEM, U-CHANNEL	55	EA.

**INDEX**

SHEET NO.	DESCRIPTION
SIGN-1	TITLE SHEET
SIGN-1A	GROUND MOUNTED SIGN SUPPORTS
SIGN-2	SUPPORT INFORMATION
SIGN-3-3A	E AND F SHEETS
SIGN-4-4C	SIGN DESIGNS
SIGN-5-20	SIGN DETAIL SHEETS

PLAN PREPARED BY: N.C.D.O.T. SIGNING AND DELINEATION UNIT

**A. ALQUDWAH, P.E.** SIGNING & DELINEATION REGIONAL ENGINEER  
**B. RASHID** SIGNING & DELINEATION PROJECT DESIGN ENGINEER

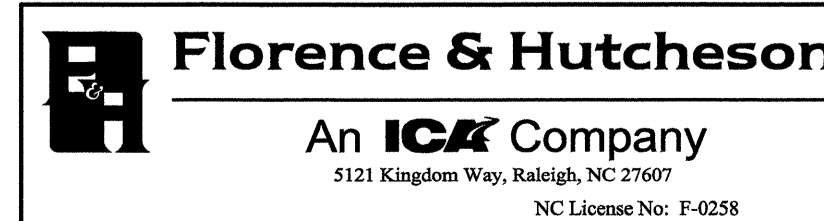
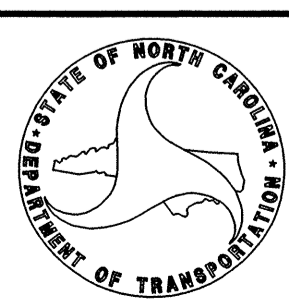

APPROVED: *RAW*  
DATE: 3/8/12



STATE OF NORTH CAROLINA  
DEPT. OF TRANSPORTATION  
DIVISION OF HIGHWAYS  
RALEIGH, N.C.

ENGLISH DETAIL DRAWING FOR  
GROUND MOUNTED SIGN SUPPORTS

SHEET 2 OF 3  
903D10

BEAM SHAPE	BOLT SIZE	SLIP BASE PLATE DATA								KEEPER PLATE DATA								HINGE CONNECTION DATA								BREAK AWAY SUPPORT WEIGHT CONSTANT LBS.
		A <sub>1</sub>	B <sub>1</sub>	C <sub>1</sub>	D <sub>1</sub>	E <sub>1</sub>	T <sub>1</sub>	R <sub>1</sub>	A <sub>2</sub>	B <sub>2</sub>	C <sub>2</sub>	D <sub>2</sub>	E <sub>2</sub>	R <sub>2</sub>	T <sub>2</sub>	BOLT SIZE	F	G	H	I	J	K	L	R <sub>3</sub>	T <sub>3</sub>	
SSX5.7	1/2"DIA. X 3"	7"	4"	1"	3/4"	2 1/2"	1"	9/32"	7"	4"	1"	3/4"	2 1/2"	9/32"	28 GAUGE	1/2"DIA. X 1 1/4"	2 1/4"	3 1/2"	4"	1/2"	1"	1 1/2"	2"	9/32"	3/8"	18
S4X7.7	1/2"DIA. X 3"	8"	4"	1"	3/4"	2 1/2"	1"	9/32"	8"	4"	1"	3/4"	2 1/2"	9/32"	28 GAUGE	1/2"DIA. X 1 1/4"	2 5/8"	3 1/2"	4"	1/2"	1"	1 1/2"	2"	9/32"	3/8"	20
W6X9	1/2"DIA. X 3"	10"	5"	1"	3/4"	3 1/2"	1"	9/32"	10"	5"	1"	3/4"	3 1/2"	9/32"	28 GAUGE	1/2"DIA. X 1 1/4"	4"	3 1/2"	4"	3/4"	1"	1 1/2"	2"	9/32"	3/8"	32
W6X12	5/8"DIA. X 3 3/4"	11"	5"	1 1/4"	7/8"	3 1/4"	1 1/4"	1 1/32"	11"	5"	1 1/4"	7/8"	3 1/4"	1 1/32"	28 GAUGE	5/8"DIA. X 2 1/4"	4"	4"	4 1/2"	3/4"	1 1/8"	5/8"	2 1/4"	1 1/32"	3/8"	39
W6X16	5/8"DIA. X 3 3/4"	12"	6"	1 1/4"	7/8"	4 1/4"	1 1/2"	1 1/32"	12"	6"	1 1/4"	7/8"	4 1/4"	1 1/32"	28 GAUGE	5/8"DIA. X 2 1/2"	4"	4"	4 1/2"	3/4"	1 1/8"	5/8"	2 1/4"	1 1/32"	1/2"	47
W8X18	5/8"DIA. X 4 1/4"	13 1/2"	6 1/2"	1 1/4"	7/8"	4 3/4"	1 1/2"	1 1/32"	13 1/2"	6 1/2"	1 1/4"	7/8"	4 3/4"	1 1/32"	28 GAUGE	5/8"DIA. X 2 1/2"	5 1/4"	4"	4 1/2"	1"	1 1/8"	5/8"	2 1/4"	1 1/32"	1/2"	70
W8X21	3/4"DIA. X 4 1/4"	14"	7"	1 1/2"	1"	5"	1 1/2"	1 3/32"	14"	7"	1 1/2"	1"	5"	1 3/32"	28 GAUGE	3/4"DIA. X 2 3/4"	5 1/4"	6"	7"	1"	1 3/4"	3/4"	3 1/2"	1 3/32"	1/2"	73
W10X22	3/4"DIA. X 4 1/4"	16"	8"	1 1/2"	1"	6"	1 1/2"	1 3/32"	16"	8"	1 1/2"	1"	6"	1 3/32"	28 GAUGE	3/4"DIA. X 2 3/4"	5 3/4"	6"	7"	1"	1 3/4"	3/4"	3 1/2"	1 3/32"	1/2"	119
W10X26	3/4"DIA. X 4 3/4"	16 1/2"	8"	1 1/2"	1"	6"	1 3/4"	1 3/32"	16 1/2"	8"	1 1/2"	1"	6"	1 3/32"	28 GAUGE	3/4"DIA. X 2 3/4"	5 3/4"	6"	7"	1"	1 3/4"	3/4"	3 1/2"	1 3/32"	5/8"	140
W12X26	3/4"DIA. X 4 3/4"	18 1/2"	9"	1 1/2"	1"	7"	1 3/4"	1 3/32"	18 1/2"	9"	1 1/2"	1"	7"	1 3/32"	28 GAUGE	3/4"DIA. X 2 3/4"	6 1/2"	6"	7"	1"	1 3/4"	3/4"	3 1/2"	1 3/32"	5/8"	176
W14X30	1"DIA. X 5"	22"	9"	2"	1 1/2"	6"	2"	1 7/32"	22"	9"	2"	1 1/2"	6"	1 7/32"	28 GAUGE	1"DIA. X 3"	6 3/4"	7"	8"	1 1/4"	2"	1"	4"	1 7/32"	5/8"	205
W16X31	1"DIA. X 5"	24"	9"	2"	1 1/2"	6"	2"	1 7/32"	24"	9"	2"	1 1/2"	6"	1 7/32"	28 GAUGE	1"DIA. X 3 1/4"	5 1/2"	7"	8"	1 1/4"	2"	1"	4"	1 7/32"	3/4"	223
W18X35	1"DIA. X 5"	25"	9"	2"	1 1/2"	6"	2"	1 7/32"	25"	9"	2"	1 1/2"	6"	1 7/32"	28 GAUGE	1"DIA. X 3 1/4"	6"	7"	8"	1 1/4"	2"	1"	4"	1 7/32"	3/4"	243
W18X40	1"DIA. X 5 1/2"	26"	9"	2"	1 1/2"	6"	2 1/4"	1 7/32"	26"	9"	2"	1 1/2"	6"	1 7/32"	28 GAUGE	1"DIA. X 3 3/4"	6"	7"	8"	1 1/4"	2"	1"	4"	1 7/32"	7/8"	278
W21X44	1"DIA. X 5 1/2"	29"	9"	2"	1 1/2"	6"	2 1/2"	1 7/32"	29"	9"	2"	1 1/2"	6"	1 7/32"	28 GAUGE	1"DIA. X 3 3/4"	6 1/2"	7"	8"	1 1/4"	2"	1"	4"	1 7/32"	7/8"	310

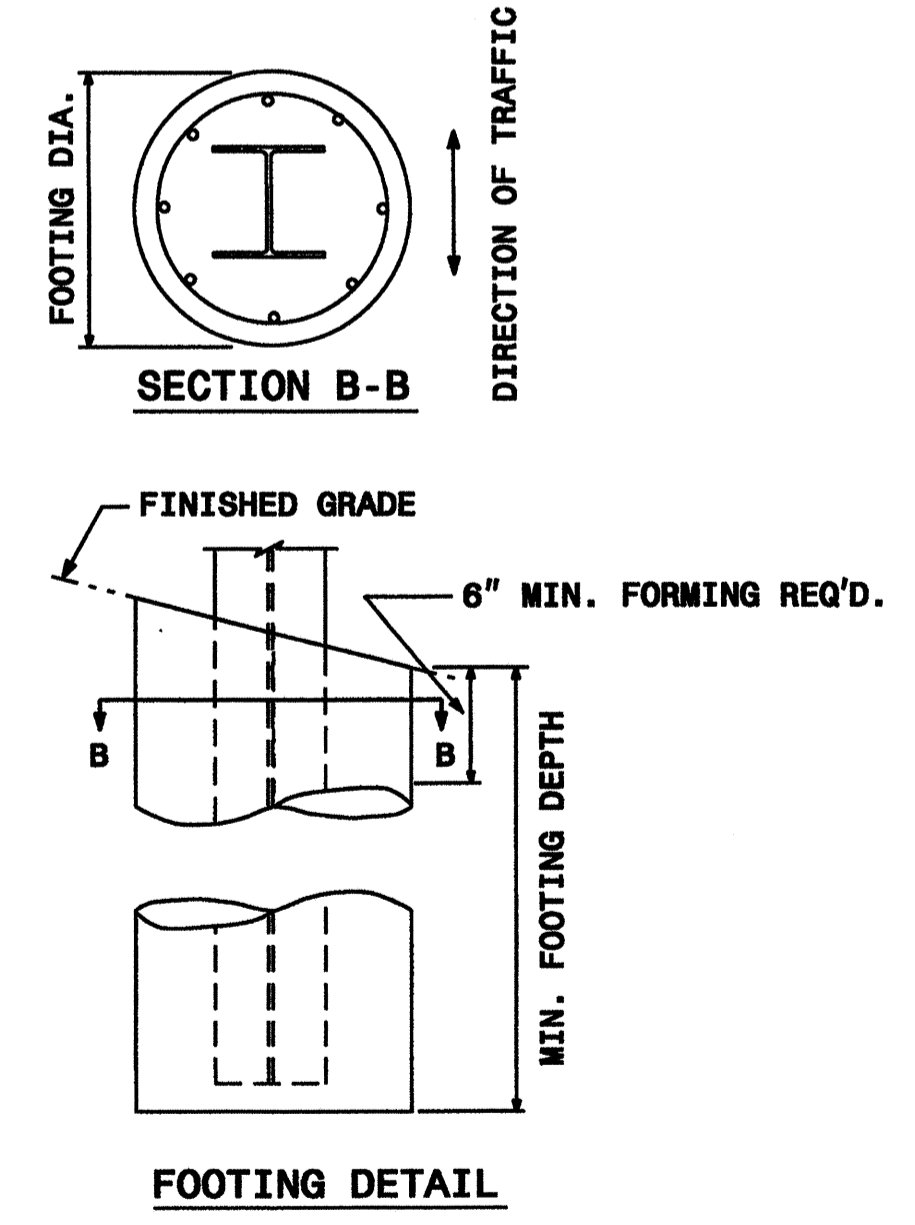
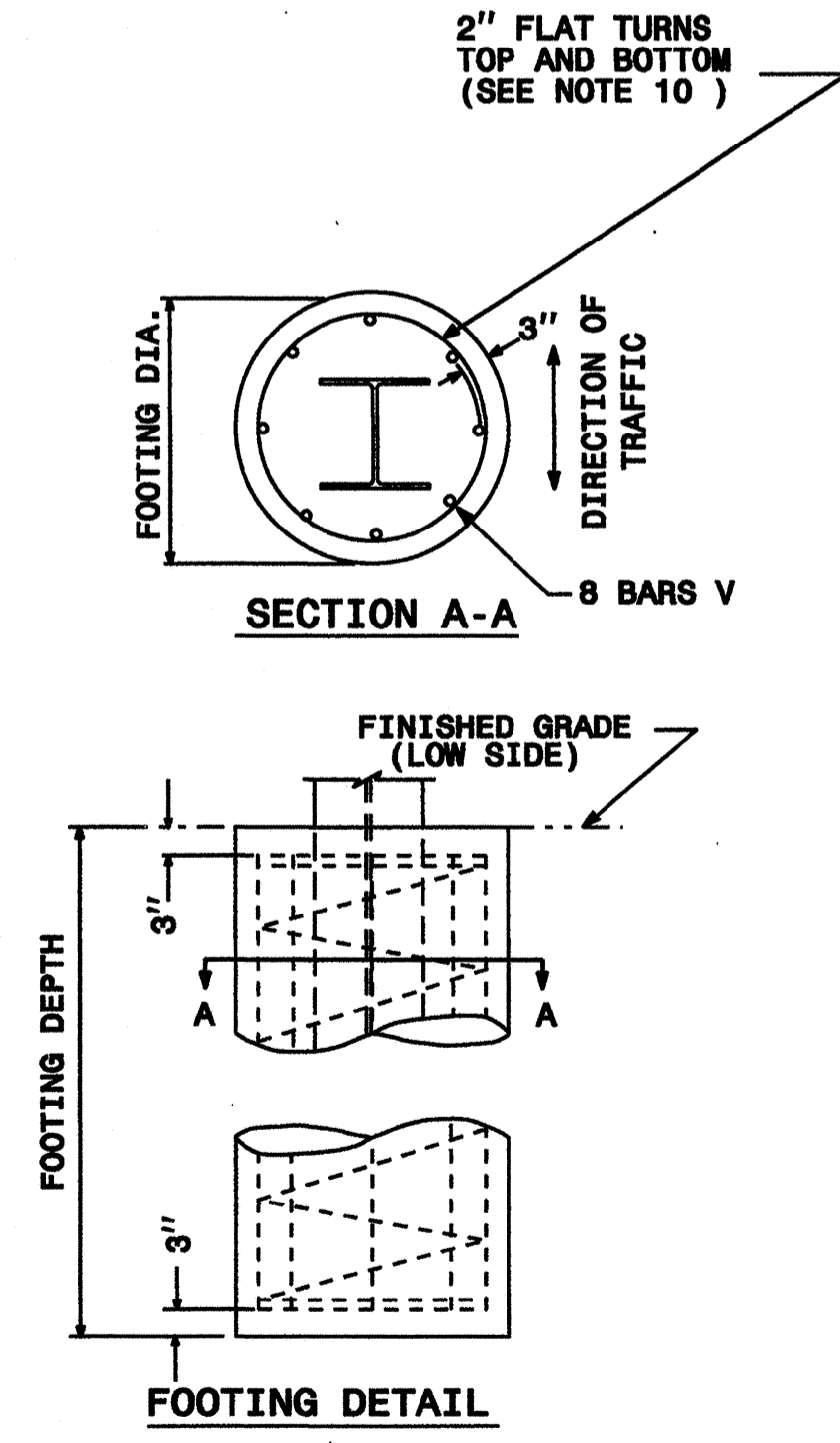

FOUNDATION DATA *		
FOOTING DIAMETER	REINFORCEMENT	SPIRAL BAR
1' 6"	8 # 6 BARS	#3 BAR, 6" PITCH
2'	8 # 7 BARS	#3 BAR, 6" PITCH
2' 6"	8 # 9 BARS	#3 BAR, 6" PITCH
3'	8 # 11 BARS	#3 BAR, 6" PITCH
3' 6"	8 # 12 BARS	#3 BAR, 6" PITCH
4'	8 # 14 BARS	#3 BAR, 6" PITCH

\* FOUNDATION DIMENSIONS ARE SHOWN IN PLANS

STATE OF NORTH CAROLINA  
DEPT. OF TRANSPORTATION  
DIVISION OF HIGHWAYS  
RALEIGH, N.C.

ENGLISH DETAIL DRAWING FOR  
GROUND MOUNTED SIGN SUPPORTS

SHEET 2 OF 3  
903D10

08-MAR-2012 11:00 S:\S&D\Standard Drawings\Standard Dwg 8-17-11\Revised\0903D10\_sgn\_sht02\_gm support\_t\_Revised\_Scaled.dgn AT TE244745

TIP NO. R-2303C	SHEET NO. SIGN-2
APPROVED: <i>[Signature]</i>	
DATE: 2-16-13	
SEAL	

SIGN NO.	SIGN TYPE	SIGN SIZE (in.)			ROADWAY STATION	NO. OF SUP.	BEAM SECTION	SUPPORT TYPE	ATTACH METHOD	MOUNTING METHOD	HORIZ. CLR.* (ft.)	LENGTH (ft.)			LEFT SUPPORT (ft.)			CENTER SUPPORT (ft.)			RIGHT SUPPORT (ft.)			FOOTING DIAMETE (ft.)	FOOTING DEPTH (ft.)	B/A SUPPORT WEIGHTS (lbs.)	SIMPLE SUPPORT WEIGHTS (lbs.)	REINF. FTGS. (c.y.)	PLAIN FTGS. (c.y.)	FIELD VERIFIED SEE NOTE 2 (mm/dd/yy)																				
		w	x	h								SNS HT	MTG HT	EMBED	S	L	TOTAL LENGTH	S	L	TOTAL LENGTH	S	L	TOTAL LENGTH																											
101	B	120	X	42	828+00	2	W6x12	BA	N/A	N/A	30.00	3.50	7.00	4	5.20	15.70	19.70	0.00	0.00	0.00	6.42	16.92	20.92	1.5	4.5	572.84	0.00	0.59	0.00																					
																								TOTAL	TOTAL	TOTAL	TOTAL																							
																								572.84	0.00	0.59	0.00																							
																								USE:	573	0	1	0																						

**NOTES**

- DIMENSION "S" REPRESENTS AN INCREASE (+), OR A DECREASE (-) IN POLE LENGTH, RELATIVE TO THE ELEVATION OF THE EDGE OF PAVEMENT.
- FIELD VERIFICATIONS SHALL BE REQUIRED FOR ALL SUPPORTS, SEE (\*) ARTICLE 903-3. FABRICATORS SHALL BE AISC CERTIFIED IN CATEGORY 1, SEE (\*) ARTICLE 1072-1. (\*) = N.C.D.O.T. STANDARD SPECIFICATIONS FOR ROADS AND STRUCTURES
- PLAN LOCATIONS FOR EXISTING UTILITIES ARE BASED ON THE BEST AVAILABLE INFORMATION AND, THEREFORE MAY NOT BE PRECISELY ACCURATE. THEREFORE, IT IS INCUMBENT UPON THE CONTRACTOR TO DETERMINE THE EXACT LOCATION OF UTILITIES BEFORE BEGINNING WORK IN A LOCATION.

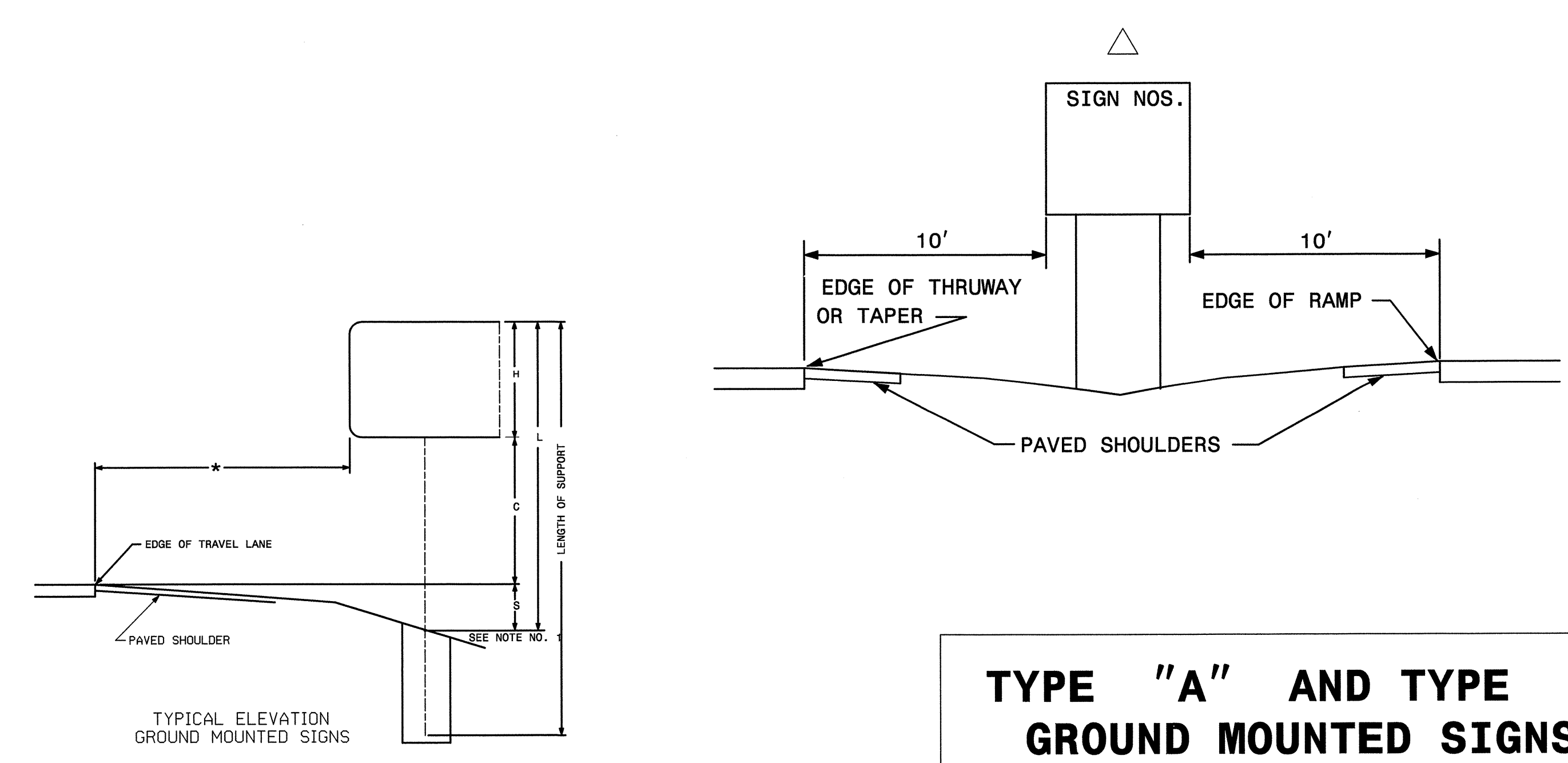

**TYPE "A" AND TYPE "B"  
GROUND MOUNTED SIGNS**

2/16/2013 P:\Signing\Delination\R-2303C\Signing\N-2303c\_sign\_support.dgn Florence & Hitchens

APPROVED: *[Signature]*

DATE: 2-16-13

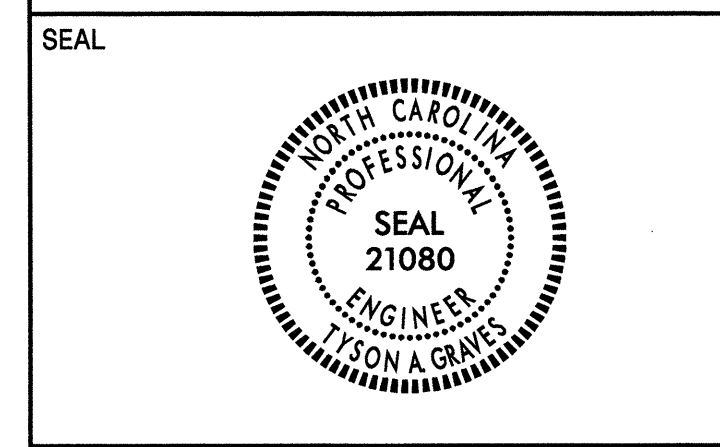

401 QUANTITY REQ'D 18

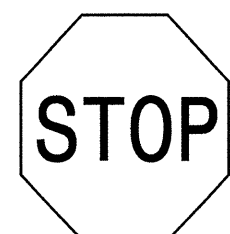

36 X 36  
R1-1

ONE "U" POST PER SIGN

MOUNT BELOW SIGN 402  
IN 18 INSTALLATIONS

402 QUANTITY REQ'D 18



54 X 18  
R6-1 (R)

TWO "U" POSTS PER SIGN

403 QUANTITY REQ'D 12



30 X 36  
R2-1

ONE "U" POST PER SIGN

404 QUANTITY REQ'D 6

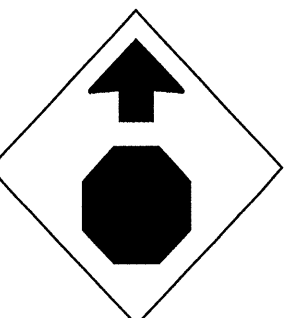

30 X 30  
W3-1a

ONE "U" POST PER SIGN

405 QUANTITY REQ'D 18

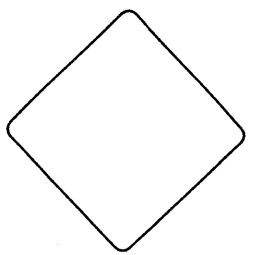

18 X 18  
OM1-3

ONE "U" POST PER SIGN  
(RED COLOR)

406 QUANTITY REQ'D 4

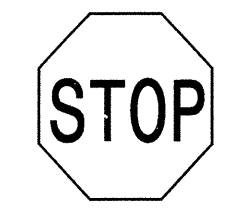

30 X 30  
R1-1

ONE "U" POST PER SIGN

407 QUANTITY REQ'D 13



54 X 18  
R6-1 (L)

TWO "U" POSTS PER SIGN

408 QUANTITY REQ'D 2

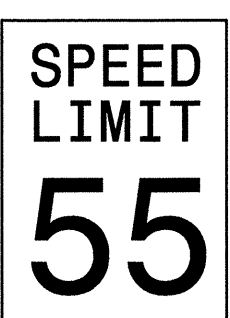

24 X 30  
R2-1

ONE "U" POST PER SIGN

409 QUANTITY REQ'D 18

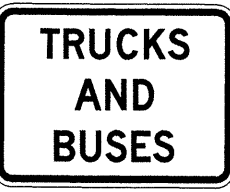

24 X 18  
(SEE SIGN DESIGN SHEET SIGN-4B)

MOUNT BELOW SIGN 410  
IN 16 INSTALLATIONS

410 QUANTITY REQ'D 18

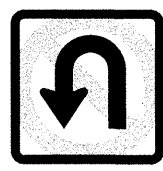

24 X 24  
R3-4

ONE "U" POST PER SIGN

411 QUANTITY REQ'D 4



30 X 30  
W14-2

ONE "U" POST PER SIGN

412 QUANTITY REQ'D 32

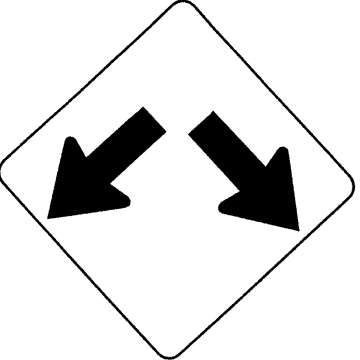

36 X 36  
W12-1

ONE "U" POST PER SIGN

413 QUANTITY REQ'D 1



36 X 36  
W14-12

ONE "U" POST PER SIGN

414 QUANTITY REQ'D 13

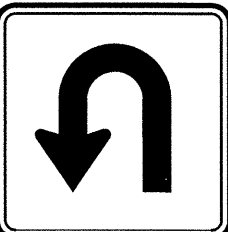

24 X 24  
SEE SIGN DESIGN

MOUNT BELOW SIGN 502, 506, 508,  
515, 537, 542, 546, 550, 555, 558,  
564, 565, 568 IN 13 INSTALLATIONS

2/16/2013 P:\Signing\Del\Ineation\R-2303C\Signing\--2303c.e-signs.dgn Florence & Hutcheson

APPROVED: *[Signature]*  
DATE: 2-16-13

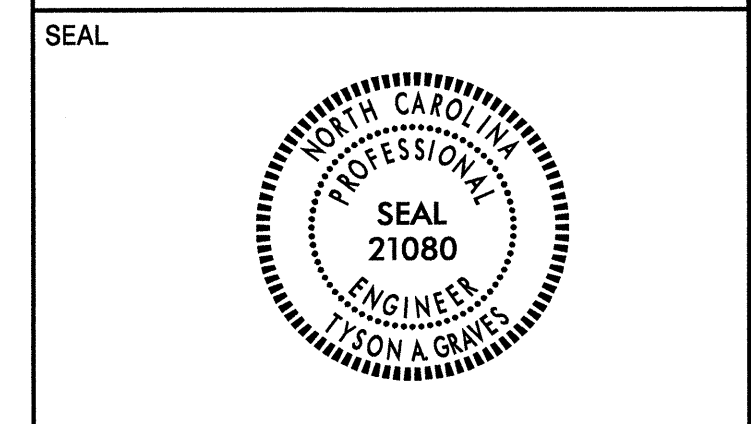

503  
543  
553

1-21 X 15  
1-24 X 12  
1-24 X 24

ONE "U" POST PER SIGN

510  
516  
540  
552  
560  
566

1-24 X 12  
1-24 X 24

ONE "U" POST PER SIGN

501  
512  
517  
544  
554  
559  
561  
534

1-24 X 12  
1-24 X 24

ONE "U" POST PER SIGN

504

1-24 X 12  
1-24 X 12  
1-24 X 24  
1-21 X 15

SIGN 503 MOUNT BELOW SIGN 302  
IN 1 INSTALLATION

569

1-24 X 12  
1-24 X 24  
1-21 X 15

ONE "U" POST PER SIGN

502  
508  
542  
546  
555  
565

1-24 X 12  
1-24 X 24  
1-21 X 15

SIGN 502 MOUNT BELOW SIGN 301  
IN 1 INSTALLATION  
SIGN 508 MOUNT BELOW SIGN 306  
IN 1 INSTALLATION  
SIGN 542 MOUNT BELOW SIGN 309  
IN 1 INSTALLATION  
SIGN 546 MOUNT BELOW SIGN 316  
IN 1 INSTALLATION

ONE "U" POST PER SIGN

526  
528

1-24 X 12  
1-24 X 12  
1-24 X 24

ONE "U" POST PER SIGN

505  
509  
514  
539  
549  
556  
562  
567

1-24 X 12  
2-24 X 12  
2-24 X 24  
2-21 X 15

SIGN 505 MOUNT BELOW SIGN 303  
IN 1 INSTALLATION  
SIGN 539 MOUNT BELOW SIGN 321  
IN 1 INSTALLATION  
SIGN 549 MOUNT BELOW SIGN 318  
IN 1 INSTALLATION

TWO "U" POSTS PER SIGN

522  
524  
542  
548

1-21 X 15  
1-24 X 24

ONE "U" POST PER SIGN

506  
515  
537  
550  
558  
564  
568

1-24 X 12  
1-24 X 24  
1-21 X 15

SIGN 506 MOUNT BELOW SIGN 304  
IN 1 INSTALLATION  
SIGN 537 MOUNT BELOW SIGN 310  
IN 1 INSTALLATION  
SIGN 550 MOUNT BELOW SIGN 320  
IN 1 INSTALLATION

ONE "U" POST PER SIGN

511  
513  
525  
535  
557  
563

1-24 X 12  
2-24 X 12  
2-24 X 24  
2-21 X 15

SIGN 535 MOUNT BELOW SIGN 311  
IN 1 INSTALLATION

TWO "U" POSTS PER SIGN

551

1-24 X 12  
1-24 X 12  
1-24 X 24  
1-21 X 15

SIGN 551 MOUNT BELOW SIGN 319  
IN 1 INSTALLATION

527  
531

1-24 X 12  
1-24 X 12  
1-24 X 24

ONE "U" POST PER SIGN

545

1-24 X 12  
1-24 X 12  
1-24 X 24  
1-21 X 15

SIGN 545 MOUNT BELOW SIGN 317  
IN 1 INSTALLATION

ONE "U" POST PER SIGN

507

1-24 X 12  
2-24 X 12  
2-24 X 24  
2-21 X 15

SIGN 507 MOUNT BELOW SIGN 305  
IN 1 INSTALLATION

TWO "U" POSTS PER SIGN

518  
541  
569  
570

1-21 X 15  
1-24 X 24

ONE "U" POST PER SIGN

519

1-24 X 12  
1-24 X 24  
1-21 X 15

SIGN 519 MOUNT BELOW SIGN 308  
IN 1 INSTALLATION

520

1-24 X 12  
1-24 X 24  
1-21 X 15

ONE "U" POST PER SIGN

521

1-24 X 12  
1-24 X 24

ONE "U" POST PER SIGN

523

1-24 X 12  
1-24 X 24

ONE "U" POST PER SIGN

536

1-24 X 12  
1-24 X 24  
1-21 X 15

ONE "U" POST PER SIGN

538

1-24 X 12  
1-24 X 24  
1-21 X 15

SIGN 538 MOUNT BELOW SIGN 313  
IN 1 INSTALLATION

547

1-24 X 12  
1-24 X 24  
1-21 X 15

SIGN 547 MOUNT BELOW SIGN 315  
IN 1 INSTALLATION

529

1-24 X 12  
1-24 X 12  
1-24 X 24  
1-21 X 15  
2-24 X 12  
2-24 X 24  
2-21 X 15

TWO "U" POSTS PER SIGN

530

1-24 X 12  
1-24 X 24  
1-21 X 15  
2-24 X 12  
2-24 X 12  
2-24 X 24  
2-21 X 15

TWO "U" POSTS PER SIGN

532

1-24 X 12  
1-24 X 12  
1-24 X 24  
1-21 X 15  
2-24 X 12  
2-24 X 24  
2-21 X 15

TWO "U" POSTS PER SIGN

533

1-24 X 12  
1-24 X 24  
1-21 X 15  
2-24 X 12  
2-24 X 12  
2-24 X 24  
2-21 X 15

TWO "U" POSTS PER SIGN

2/16/2013 P:\Signing\Delineation\R-2303C\Signimg\--2303c-f\_sigs.dgn Florence & Hutcheson

APPROVED: *[Signature]*

DATE: 2-16-13

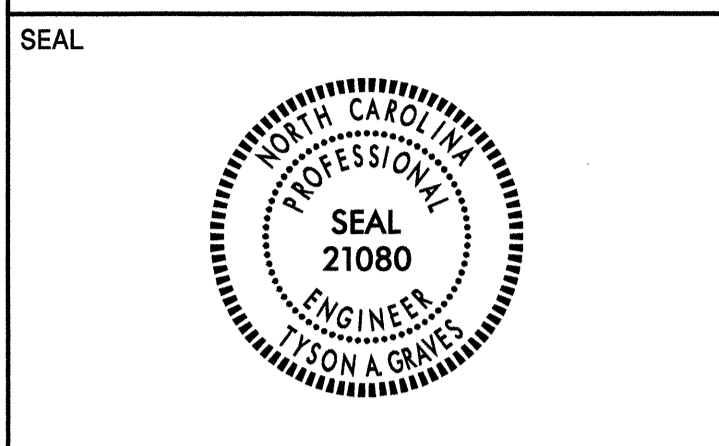

**SIGN NUMBER:** 101  
**TYPE:** B  
**QUANTITY:** 1  
**SIGN WIDTH:** 10'-0"  
**HEIGHT:** 3'-6"  
**TOTAL AREA:** 35.0 Sq.Ft.  
**BORDER TYPE:** FLUSH  
**RECESS:** 0"  
**WIDTH:** 1.75"  
**RADII:** 6"  
**NO. Z BARS:** 2  
**LENGTH:** 112.0

**BACKG COLOR:** Green  
**COPY COLOR:** White

SYMBOL	X	Y	WID	HT

**MAT'L:** 0.125" (3.2 mm) ALUMINUM

**DESIGN BY:** GEP  
**PROJECT ID:** R-2303C  
**CHECKED BY:** DIV: DIV 3  
**DATE:** Oct 17, 2012

**USE NOTES:** 1, 2  
 1. Legend and border(except those that are colored black) shall be direct applied Grade C sheeting.  
 2. Background shall be Grade C reflective sheeting.  
 3. Shields; A, B, and C type arrows shall be on 0.032" (0.8mm) aluminum and demountable.

Spacing Factor is 1 unless specified otherwise

**LETTER POSITIONS**

Letter spacings are to start of next letter										Series/Size
										Text Length
10.4	8.2	6	7	8.5	11.3	8.5	5.3	54.9		EM 2000
										54.7
102.8	4.5	2.4	10.4							EM 2000
										6.9
10.4	7.4	7.6	8.4	7	5.9	6	6.9	8.5	4.8	EM 2000
										76.6
										EM 2000
										14.7

FILENAME: sign designs NORTH CAROLINA D.O.T. SIGN DETAIL

**SIGN NUMBER:** 301,306  
**TYPE:** D  
**QUANTITY:** 4  
**SIGN WIDTH:** 6'-0"  
**HEIGHT:** 2'-0"  
**TOTAL AREA:** 12.0 Sq.Ft.  
**BORDER TYPE:** FLUSH  
**RECESS:** 0"  
**WIDTH:** 1"  
**RADII:** 3"  
**NO. Z BARS:** 1  
**LENGTH:**

**BACKG COLOR:** Green  
**COPY COLOR:** White

SYMBOL	X	Y	WID	HT
ARSHRT	9.5	8	8	12

**MAT'L:** 0.125" (3.2 mm) ALUMINUM

**DESIGN BY:** GEP  
**PROJECT ID:** R-2303C  
**CHECKED BY:** DIV: DIV 3  
**DATE:** Oct 17, 2012

**USE NOTES:** 1,2  
 1. Legend and border(except those that are colored black) shall be direct applied Grade C sheeting.  
 2. Background shall be Grade C reflective sheeting.

Spacing Factor is 1 unless specified otherwise

**LETTER POSITIONS**

Letter spacings are to start of next letter										Series/Size
										Text Length
29.5	7	2.9	2.9	5.5	3.8	6.2	4.7	9.5		D 2000
										33

FILENAME: sign designs NORTH CAROLINA D.O.T. SIGN DETAIL

**SIGN NUMBER:** 302,317  
**TYPE:** D  
**QUANTITY:** 2  
**SIGN WIDTH:** 6'-6"  
**HEIGHT:** 2'-0"  
**TOTAL AREA:** 13.0 Sq.Ft.  
**BORDER TYPE:** FLUSH  
**RECESS:** 0"  
**WIDTH:** 1"  
**RADII:** 3"  
**NO. Z BARS:** 1  
**LENGTH:**

**BACKG COLOR:** Green  
**COPY COLOR:** White

SYMBOL	X	Y	WID	HT
ARSHRT	58.4	8	8	12

**MAT'L:** 0.125" (3.2 mm) ALUMINUM

**DESIGN BY:** GEP  
**PROJECT ID:** R-2303C  
**CHECKED BY:** DIV: DIV 3  
**DATE:** Oct 17, 2012

**USE NOTES:** 1,2  
 1. Legend and border(except those that are colored black) shall be direct applied Grade C sheeting.  
 2. Background shall be Grade C reflective sheeting.

Spacing Factor is 1 unless specified otherwise

**LETTER POSITIONS**

Letter spacings are to start of next letter										Series/Size
										Text Length
7.6	6.3	5.7	4.5	5.8	5.8	6.2	3.7	4.9	27.6	D 2000
										42.8

FILENAME: sign designs NORTH CAROLINA D.O.T. SIGN DETAIL

**SIGN NUMBER:** 303,318,321  
**TYPE:** D  
**QUANTITY:** 3  
**SIGN WIDTH:** 7'-0"  
**HEIGHT:** 2'-6"  
**TOTAL AREA:** 17.5 Sq.Ft.  
**BORDER TYPE:** FLUSH  
**RECESS:** 0"  
**WIDTH:** 0.75"  
**RADII:** 3"  
**NO. Z BARS:** 1  
**LENGTH:**

**BACKG COLOR:** Green / Green  
**COPY COLOR:** White

SYMBOL	X	Y	WID	HT
ARSHRT	68	19.3	6	9
ARSHRT	52.9	4.7	6	9

**MAT'L:** 0.125" (3.2 mm) ALUMINUM

**DESIGN BY:** GEP  
**PROJECT ID:** R-2303C  
**CHECKED BY:** DIV: DIV 3  
**DATE:** Oct 17, 2012

**USE NOTES:** 1,2  
 1. Legend and border(except those that are colored black) shall be direct applied Grade C sheeting.  
 2. Background shall be Grade C reflective sheeting.

Spacing Factor is 1 unless specified otherwise

**LETTER POSITIONS**

Letter spacings are to start of next letter															Series/Size
															Text Length
7	4.3	3.7	6	4.2	4.1	5	3.8	2.5	2.8	3.9	5	2.2	2.2	1.9	D 2000
															55
22.1	5.3	2.2	2.2	4.1	2.8	4.6	3.5	37.1							D 2000
															24.7

FILENAME: sign designs NORTH CAROLINA D.O.T. SIGN DETAIL

2/16/2013 P:\Signing&Deletion\IR-2303C\Signing\2303c-sign-design-sheet1.dgn Florence & Hutcheson

APPROVED: *[Signature]*

DATE: 2-16-13

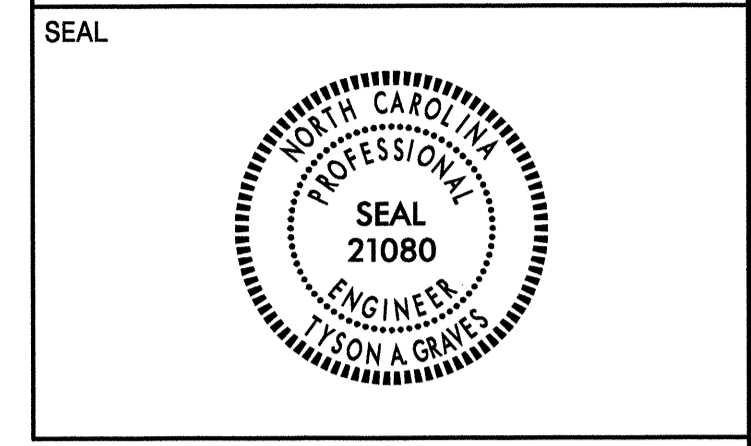

SIGN NUMBER: 304,310,320      BACKG COLOR: Green  
 TYPE: D      COPY COLOR: White      DESIGN BY: GEP      CHECKED BY:      DATE: Oct 17, 2012  
 QUANTITY: 3      PROJECT ID: R-2303C      DIV: DIV 3

SYMBOL	X	Y	WID	HT
ARSHRT	7.6	8	8	12

SIGN WIDTH: 7'-6"  
 HEIGHT: 2'-0"  
 TOTAL AREA: 15.0 Sq.Ft.

BORDER TYPE: FLUSH  
 RECESS: 0"  
 WIDTH: 1"  
 RADII: 3"

NO. Z BARS:      MAT'L: 0.125" (3.2 mm) ALUMINUM  
 LENGTH:

USE NOTES: 1,2  
 1. Legend and border(except those that are colored black) shall be direct applied Grade C sheeting.  
 2. Background shall be Grade C reflective sheeting.

LETTER POSITIONS

Letter spacings are to start of next letter													Series/Size	
													Text Length	
27.6	5.6	5.4	6.6	5.1	3.4	3.8	5.2	6.6	2.9	2.9	2.6	4.7	7.6	D 2000
													54.8	

FILENAME: sign designs      NORTH CAROLINA D.O.T. SIGN DETAIL

SIGN NUMBER: 305,319      BACKG COLOR: Green  
 TYPE: D      COPY COLOR: White      DESIGN BY: GEP      CHECKED BY:      DATE: Oct 17, 2012  
 QUANTITY: 2      PROJECT ID: R-2303C      DIV: DIV 3

SYMBOL	X	Y	WID	HT
ARSHRT	7.6	8	8	12

SIGN WIDTH: 6'-6"  
 HEIGHT: 2'-0"  
 TOTAL AREA: 13.0 Sq.Ft.

BORDER TYPE: FLUSH  
 RECESS: 0"  
 WIDTH: 1"  
 RADII: 3"

NO. Z BARS:      MAT'L: 0.125" (3.2 mm) ALUMINUM  
 LENGTH:

USE NOTES: 1,2  
 1. Legend and border(except those that are colored black) shall be direct applied Grade C sheeting.  
 2. Background shall be Grade C reflective sheeting.

LETTER POSITIONS

Letter spacings are to start of next letter													Series/Size
													Text Length
27.6	6.3	5.7	4.5	5.8	5.8	6.2	3.7	4.9	7.6				D 2000
													42.8

FILENAME: sign designs      NORTH CAROLINA D.O.T. SIGN DETAIL

SIGN NUMBER: 307      BACKG COLOR: Green  
 TYPE: D      COPY COLOR: White      DESIGN BY: GEP      CHECKED BY:      DATE: Oct 17, 2012  
 QUANTITY: 1      PROJECT ID: R-2303C      DIV: DIV 3

SYMBOL	X	Y	WID	HT
ARSHRT	6.9	9	6	9

SIGN WIDTH: 5'-0"  
 HEIGHT: 2'-0"  
 TOTAL AREA: 10.0 Sq.Ft.

BORDER TYPE: FLUSH  
 RECESS: 0"  
 WIDTH: 0.75"  
 RADII: 3"

NO. Z BARS:      MAT'L: 0.125" (3.2 mm) ALUMINUM  
 LENGTH:

USE NOTES: 1,2  
 1. Legend and border(except those that are colored black) shall be direct applied Grade C sheeting.  
 2. Background shall be Grade C reflective sheeting.

LETTER POSITIONS

Letter spacings are to start of next letter													Series/Size
													Text Length
21.9	3.5	3.9	3.7	3.4	6.1	3.8	3.8	3.1	6.9				C 2000
													31.2
27.4	4.1	3.7	3.9	3.8	4	0.8	12.4						C 2000
													20.3

FILENAME: sign designs      NORTH CAROLINA D.O.T. SIGN DETAIL

SIGN NUMBER: 308      BACKG COLOR: Green  
 TYPE: D      COPY COLOR: White      DESIGN BY: TAG      CHECKED BY:      DATE: Feb 11, 2013  
 QUANTITY: 1      PROJECT ID: R-2303C      DIV: DIV 3

SYMBOL	X	Y	WID	HT
AR_Type D	8.5	18.4	8	12
AR_Type D	69.5	3.3	8	12

SIGN WIDTH: 7'-6"  
 HEIGHT: 2'-6"  
 TOTAL AREA: 18.8 Sq.Ft.

BORDER TYPE: FLUSH  
 RECESS: 0"  
 WIDTH: 1"  
 RADII: 2.25"

NO. Z BARS:      MAT'L: 0.125" (3.2 mm) ALUMINUM  
 LENGTH:

USE NOTES: 1,2  
 1. Legend and border(except those that are colored black) shall be direct applied Grade C sheeting.  
 2. Background shall be Grade C reflective sheeting.

LETTER POSITIONS

Letter spacings are to start of next letter													Series/Size
													Text Length
30.6	6.2	6.1	2.6	5.8	9.4	6	6.3	3.7	4.8	8.5			D 2000
													51
11.4	6.3	5.7	4.5	5.8	5.8	6.2	3.7	4.9	35.8			D 2000	
													42.8

FILENAME: sign designs      NORTH CAROLINA D.O.T. SIGN DETAIL

2/16/2013 P:\Signing\Delination\R-2303C\Signing\--2303c-sign-design-sheet2.dgn Florence & Hutcheson

APPROVED: *[Signature]*

DATE: 2-16-13

SEAL



SIGN NUMBER: 312 TYPE: D QUANTITY: 1  
 BACKG COLOR: Green COPY COLOR: White  
 DESIGN BY: GEP CHECKED BY: DIV: DIV 3 DATE: Oct 17, 2012  
 PROJECT ID: R-2303C

SYMBOL	X	Y	WID	HT
ARSHRT	44.3	9	6	9

SIGN WIDTH: 5'-0" HEIGHT: 2'-0" TOTAL AREA: 10.0 Sq.Ft.  
 BORDER TYPE: FLUSH RECESS: 0" WIDTH: 0.75" RADII: 3"  
 NO. Z BARS: LENGTH:

MAT'L: 0.125" (3.2 mm) ALUMINUM

USE NOTES: 1,2  
 1. Legend and border(except those that are colored black) shall be direct applied Grade C sheeting.  
 2. Background shall be Grade C reflective sheeting.

Spacing Factor is 1 unless specified otherwise

LETTER POSITIONS

Letter spacings are to start of next letter											Series/Size
											Text Length
6.7	3.5	3.9	3.7	3.4	6.1	3.8	3.8	3.1	22.1		C 2000
											31.2
12.4	4.1	3.7	3.9	3.8	4	0.8	27.4				C 2000
											20.3

FILENAME: sign designs NORTH CAROLINA D.O.T. SIGN DETAIL

SIGN NUMBER: 313 TYPE: D QUANTITY: 1  
 BACKG COLOR: Green / Green COPY COLOR: White  
 DESIGN BY: GEP CHECKED BY: DIV: DIV 3 DATE: Oct 17, 2012  
 PROJECT ID: R-2303C

SYMBOL	X	Y	WID	HT
ARSHRT	13.6	27.3	8	12
ARSHRT	66.5	6.8	8	12

SIGN WIDTH: 7'-6" HEIGHT: 3'-6" TOTAL AREA: 26.3 Sq.Ft.  
 BORDER TYPE: FLUSH RECESS: 0" WIDTH: 1" RADII: 6"  
 NO. Z BARS: LENGTH:

MAT'L: 0.125" (3.2 mm) ALUMINUM

USE NOTES: 1,2  
 1. Legend and border(except those that are colored black) shall be direct applied Grade C sheeting.  
 2. Background shall be Grade C reflective sheeting.

Spacing Factor is 1 unless specified otherwise

LETTER POSITIONS

Letter spacings are to start of next letter											Series/Size
											Text Length
33.6	6.3	5.7	4.5	5.8	5.8	6.2	3.7	4.9	13.6		D 2000
											42.8
9.5	6.2	6.1	2.6	5.8	9.4	6	6.3	3.7	4.8	29.5	D 2000
											51

FILENAME: sign designs NORTH CAROLINA D.O.T. SIGN DETAIL

SIGN NUMBER: 314 TYPE: D QUANTITY: 1  
 BACKG COLOR: Green COPY COLOR: White  
 DESIGN BY: GEP CHECKED BY: DIV: DIV 3 DATE: Oct 17, 2012  
 PROJECT ID: R-2303C

SYMBOL	X	Y	WID	HT
ARSHRT				

SIGN WIDTH: 7'-6" HEIGHT: 3'-6" TOTAL AREA: 26.3 Sq.Ft.  
 BORDER TYPE: FLUSH RECESS: 0" WIDTH: 1.75" RADII: 6"  
 NO. Z BARS: LENGTH:

MAT'L: 0.125" (3.2 mm) ALUMINUM

USE NOTES: 1,2  
 1. Legend and border(except those that are colored black) shall be direct applied Grade C sheeting.  
 2. Background shall be Grade C reflective sheeting.

Spacing Factor is 1 unless specified otherwise

LETTER POSITIONS

Letter spacings are to start of next letter											Series/Size
											Text Length
10.7	8.7	4.8	4.8	7.7	6	7.9	5.3	34.1			EM 2000
											45.2
68.4	4.4	6.5	10.7								EM 2000
											10.9
10.7	9.7	8.5	5	7	7.6	8.2	33.3				EM 2000
											46
64.7	8.2	6.5	10.7								EM 2000
											14.6

FILENAME: sign designs NORTH CAROLINA D.O.T. SIGN DETAIL

SIGN NUMBER: 311,315 TYPE: D QUANTITY: 2  
 BACKG COLOR: Green COPY COLOR: White  
 DESIGN BY: TAG CHECKED BY: DIV: DIV 3 DATE: Nov 30, 2012  
 PROJECT ID: R-2303C

SYMBOL	X	Y	WID	HT
AR_Type B	55.3	18.6	7.5	8.5
AR_Type B	55.3	3.9	7.5	8.5

SIGN WIDTH: 6'-0" HEIGHT: 2'-6" TOTAL AREA: 15.0 Sq.Ft.  
 BORDER TYPE: FLUSH RECESS: 0" WIDTH: 0.75" RADII: 2.25"  
 NO. Z BARS: LENGTH:

MAT'L: 0.125" (3.2 mm) ALUMINUM

USE NOTES:  
 1. Legend and border(except those that are colored black) shall be direct applied Grade B sheeting.  
 2. Background shall be Grade C reflective sheeting.  
 3. Shields: A, B, and C type arrows shall be on 0.032" (0.8mm) aluminum and demountable.

Spacing Factor is 1 unless specified otherwise

LETTER POSITIONS

Letter spacings are to start of next letter											Series/Size			
											Text Length			
10.6	4.3	3.7	6	5.3	2.2	2.2	4.1	2.8	4.6	3.5	22.7	D 2000		
											38.6			
8.2	4.2	4.1	5	3.8	2.5	2.8	3.9	5	2.2	2.2	1.9	3.5	22.7	D 2000
											41.1			

FILENAME: sign designs NORTH CAROLINA D.O.T. SIGN DETAIL

2/16/2013 F:\Signing\Delination\R-2303C\Signing\N-2303C-sign-design-sheet3.cdn Florence & Hutcheson



APPROVED: *[Signature]*  
 DATE: 2-16-13

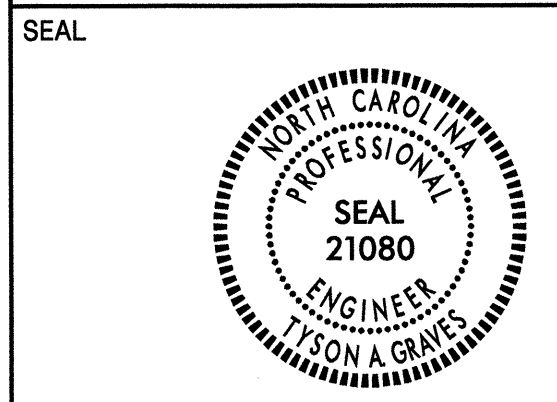

SIGN NUMBER: 322      BACKG COLOR: Green  
 TYPE: D      COPY COLOR: White  
 QUANTITY: 1

SYMBOL	X	Y	WID	HT
AR_Type B	12.2	18.6	7.5	8.5
AR_Type B	55.3	4	7.5	8.5

SIGN WIDTH: 6'-0"  
 HEIGHT: 2'-6"  
 TOTAL AREA: 15.0 Sq.Ft.

BORDER TYPE: FLUSH  
 RECESS: 0"  
 WIDTH: 0.75"  
 RADII: 2.25"

MAT'L: 0.125" (3.2 mm) ALUMINUM

DESIGN BY: TAG      CHECKED BY:  
 PROJECT ID: R-2303C      DIV: DIV 3      DATE: Feb 11, 2013

USE NOTES: 1,2  
 1. Legend and border(except those that are colored black) shall be direct applied Grade C sheeting.  
 2. Background shall be Grade C reflective sheeting.

Spacing Factor is 1 unless specified otherwise

LETTER POSITIONS

Letter spacings are to start of next letter

Series/Size	Text Length	C	l	i	n	t	o	n											
D 2000	24.7	32	5.3	2.2	2.2	4.1	2.8	4.6	3.5	15.3									
D 2000	41.1																		

FILENAME: sign designs      NORTH CAROLINA D.O.T. SIGN DETAIL

SIGN NUMBER: 409      BACKG COLOR: White  
 TYPE: E      COPY COLOR: Black  
 QUANTITY: X

SYMBOL	X	Y	WID	HT

SIGN WIDTH: 2'-0"  
 HEIGHT: 1'-6"  
 TOTAL AREA: 3.0 Sq.Ft.

BORDER TYPE: FLUSH  
 RECESS: 0.47"  
 WIDTH: 0.63"  
 RADII: 1.5"

MAT'L: 0.063" (1.6 mm) ALUMINUM

DESIGN BY: GEP      CHECKED BY:  
 PROJECT ID: R-2303C      DIV: DIV 3      DATE: Oct 17, 2012

USE NOTES: 1,2  
 1. Legend and border(except those that are colored black) shall be direct applied Grade C sheeting.  
 2. Background shall be Grade C reflective sheeting.

Spacing Factor is 1 unless specified otherwise

LETTER POSITIONS

Letter spacings are to start of next letter

Series/Size	Text Length	T	R	U	C	K	S												
D 2000	14.7	4.6	2.3	2.5	2.7	2.7	2.4	2	4.7										
D 2000	7.8																		
D 2000	11.9																		

FILENAME: sign designs      NORTH CAROLINA D.O.T. SIGN DETAIL

SIGN NUMBER: 413  
 TYPE: E  
 QUANTITY: ??

SIGN	A	B	C	D	E	F	G	H	J	K	L	M	N
SPECIAL	24	1/2	3/4	1/2	6-3/8	3-1/8	3-1/8	7-1/2	2 13/16	1-7/8	5/8	6-1/4	3-5/8

COLORS  
 ARROW AND BORDER - BLACK  
 BACKGROUND - WHITE

2/16/2013  
 P:\Signing\Delmeester\N-2303C\Signing\N-2303C-sign-design-sheet4.dgn  
 Florence & Hutcheson

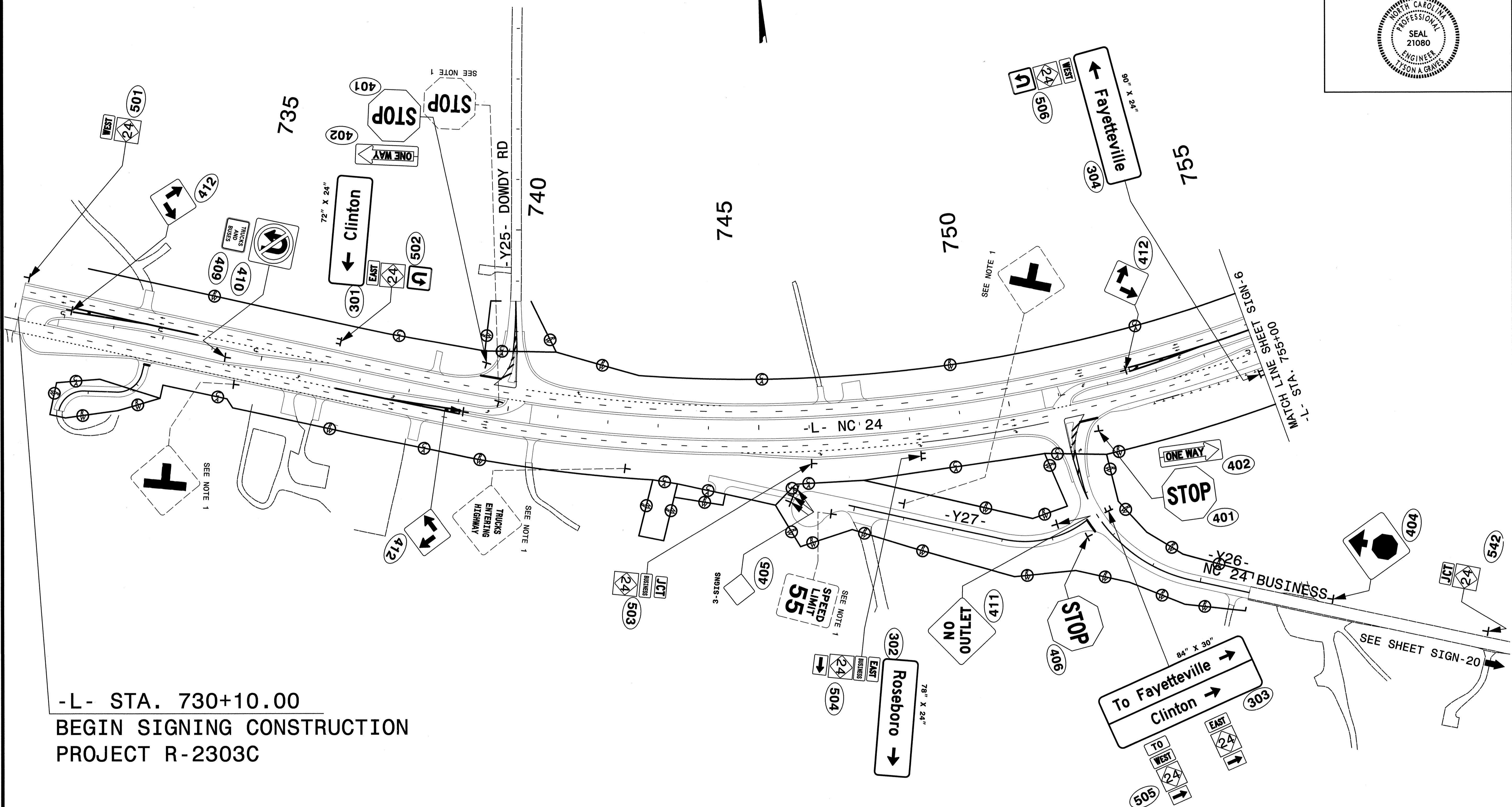
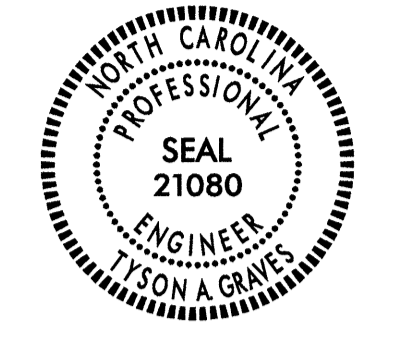

-L- STA. 730+10.00  
 BEGIN SIGNING CONSTRUCTION  
 PROJECT R-2303C

**PROJECT NOTES**

1 DISPOSAL OF SIGN SYSTEM, U-CHANNEL

**PROPOSED & EXISTING SIGNS**

2/20/2013  
 F:\Signing\Del\lineation\R-2303C\Signing\Y-2303c-sign-plan\_SIGN\_5.dgn  
 Florence & Hutcheson

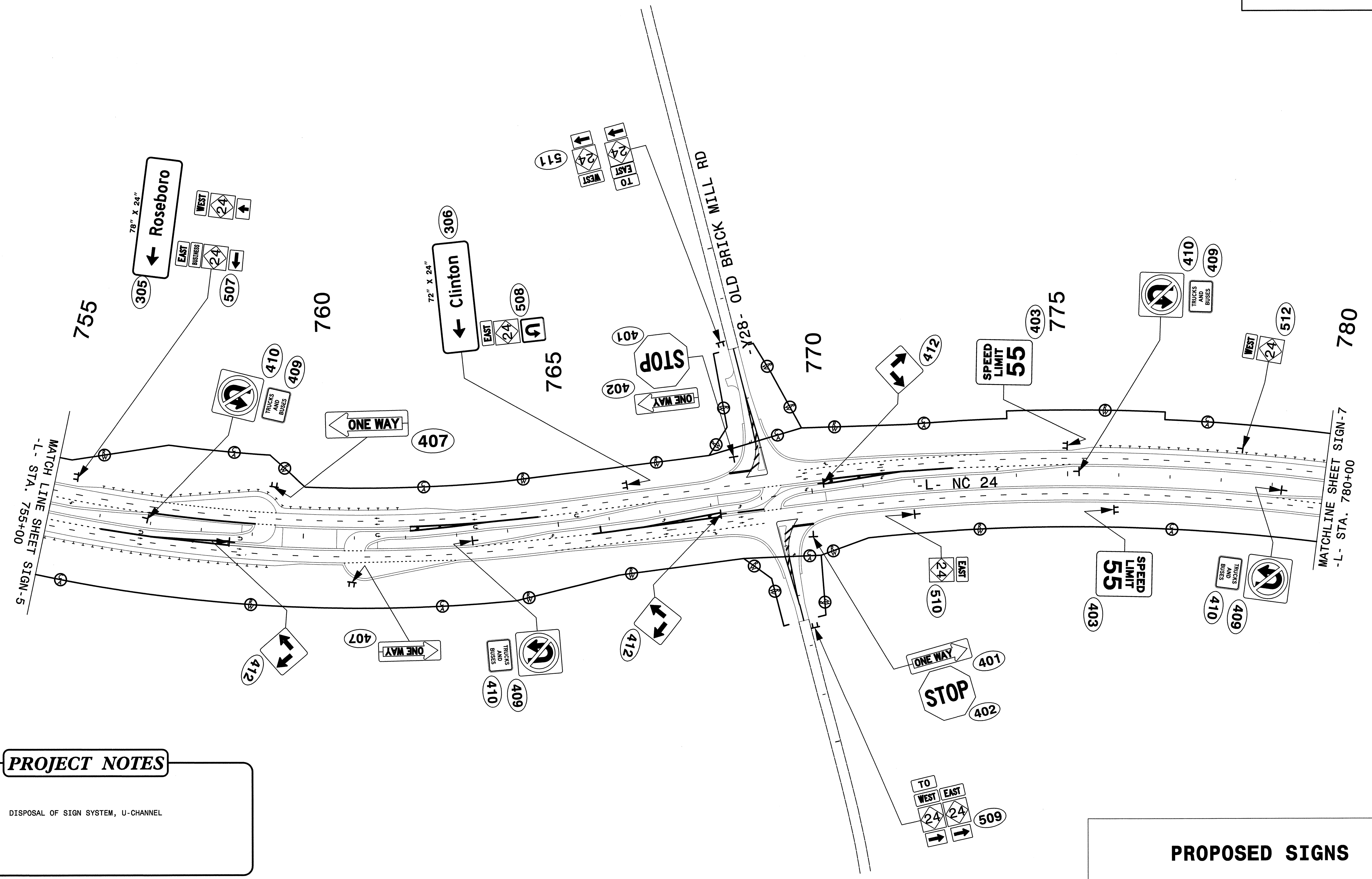
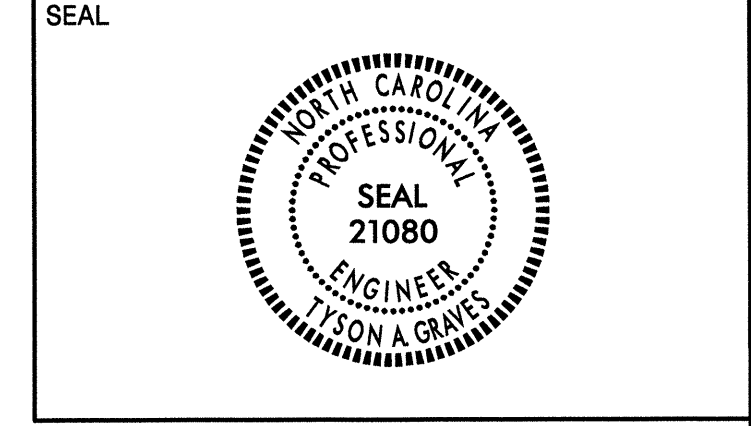

**PROJECT NOTES**

1 DISPOSAL OF SIGN SYSTEM, U-CHANNEL

**PROPOSED SIGNS**

2/16/2013  
 P:\Signing&Deletion\VR-2303C\Signing\VR-2303c-sign-plan\_SIGN-6.dgn  
 Florence & Hutcheson

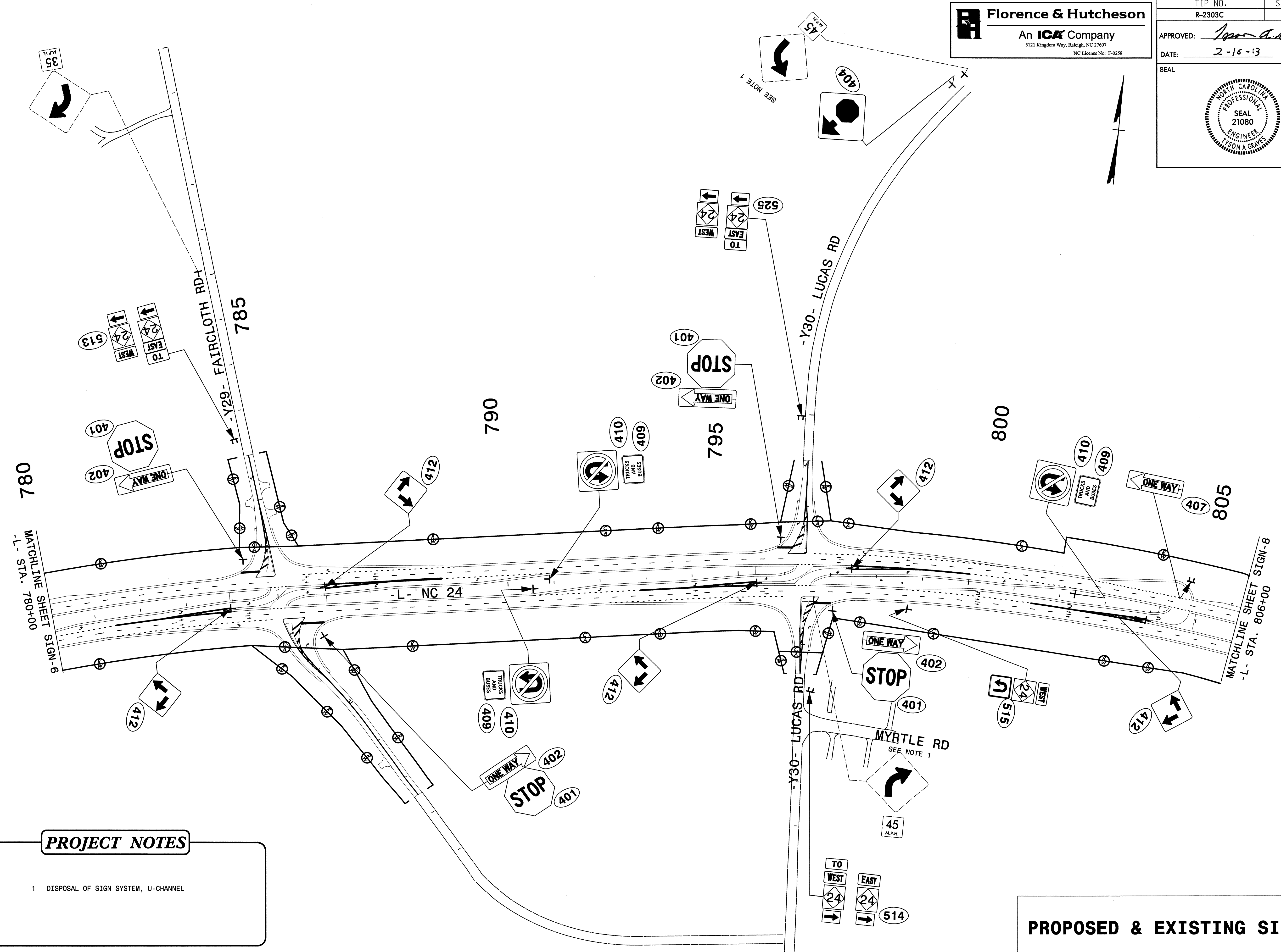

**PROJECT NOTES**

1 DISPOSAL OF SIGN SYSTEM, U-CHANNEL

**PROPOSED & EXISTING SIGNS**

2/16/2013  
 P:\Signing&Deletion\IR-2303C\Signing\2303c-sign-plan\_SIGN\_7.dgn  
 Florence & Hutcheson

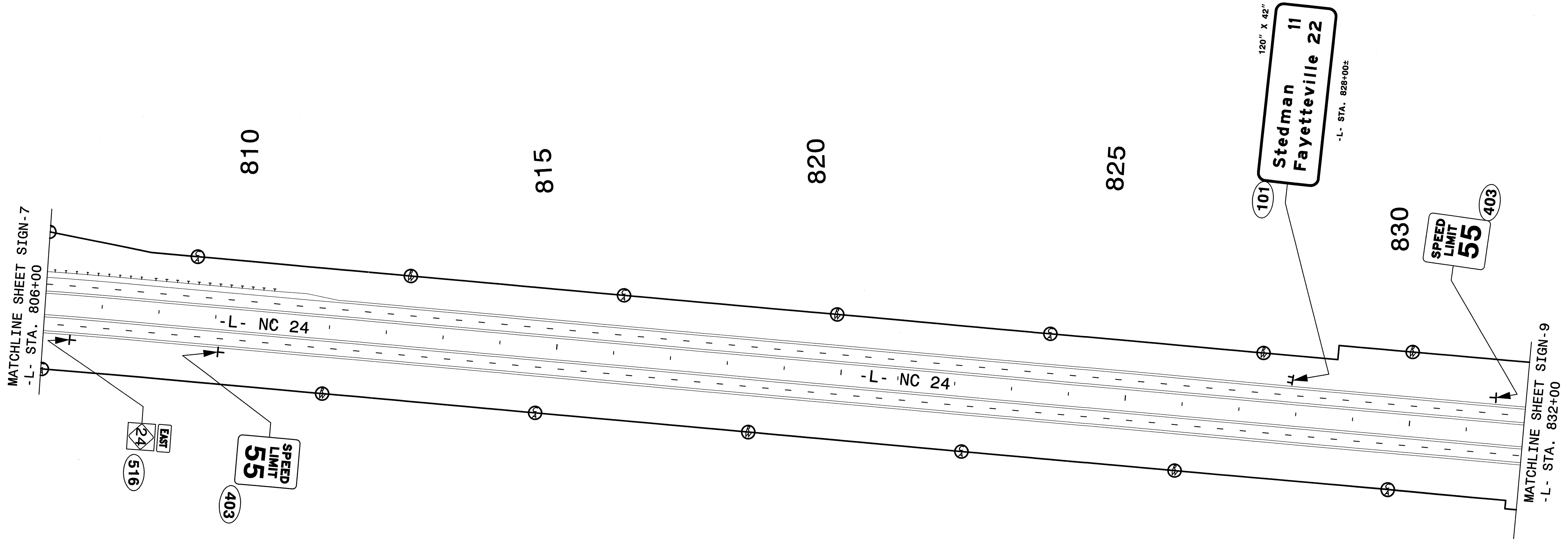

**PROJECT NOTES**

1 DISPOSAL OF SIGN SYSTEM, U-CHANNEL

**PROPOSED SIGNS**

2/16/2013  
 P:\Signing&Delinestation\R-2303C\Signing\2303c-sign-plan\_5\GN\_8.dgn  
 Florence & Hutcheson

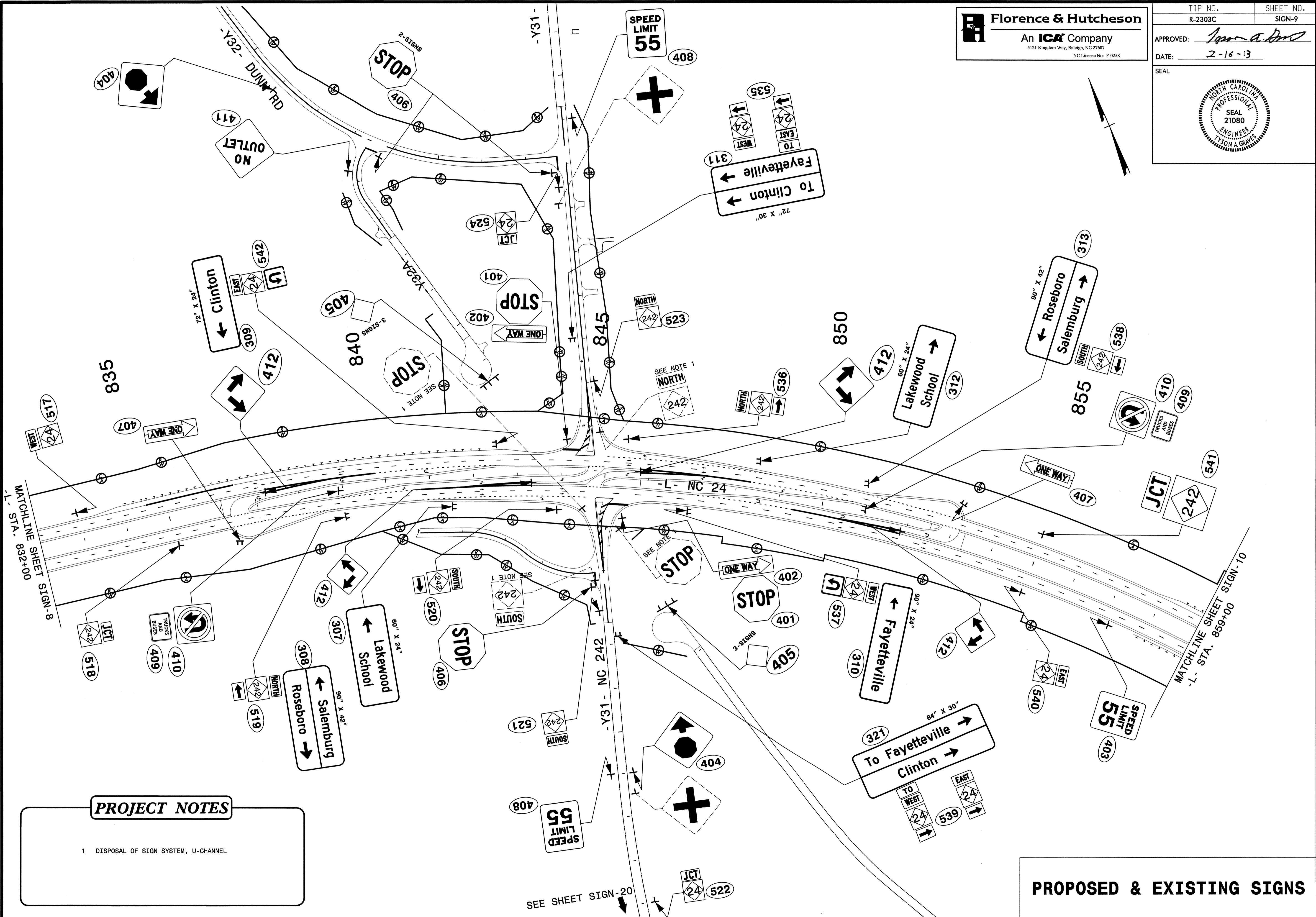
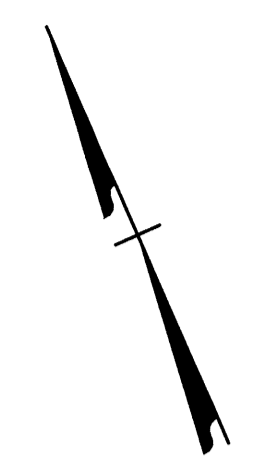

**PROJECT NOTES**

1 DISPOSAL OF SIGN SYSTEM, U-CHANNEL

**PROPOSED & EXISTING SIGNS**

2/16/2013  
 P:\Signing\Delinestation\2303C\Signing\2303c-sign-plan\_SIGN-9.dgn  
 Florence & Hutcheson

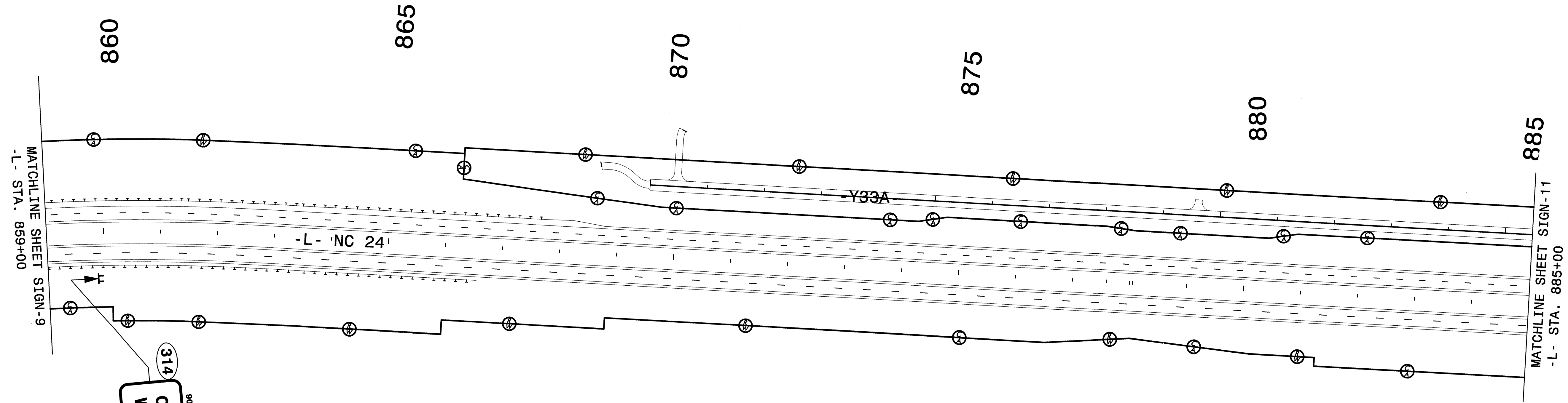
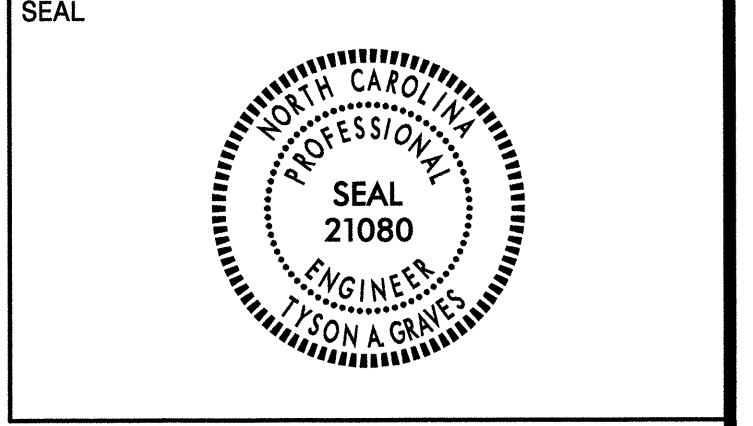

**PROJECT NOTES**

1 DISPOSAL OF SIGN SYSTEM, U-CHANNEL

**PROPOSED SIGNS**

2/16/2013  
 F:\Signing&Delineation\R-2303C\Signing\2303c\_sign\_plan\_SIGN\_10.dgn  
 Florence & Hutcheson

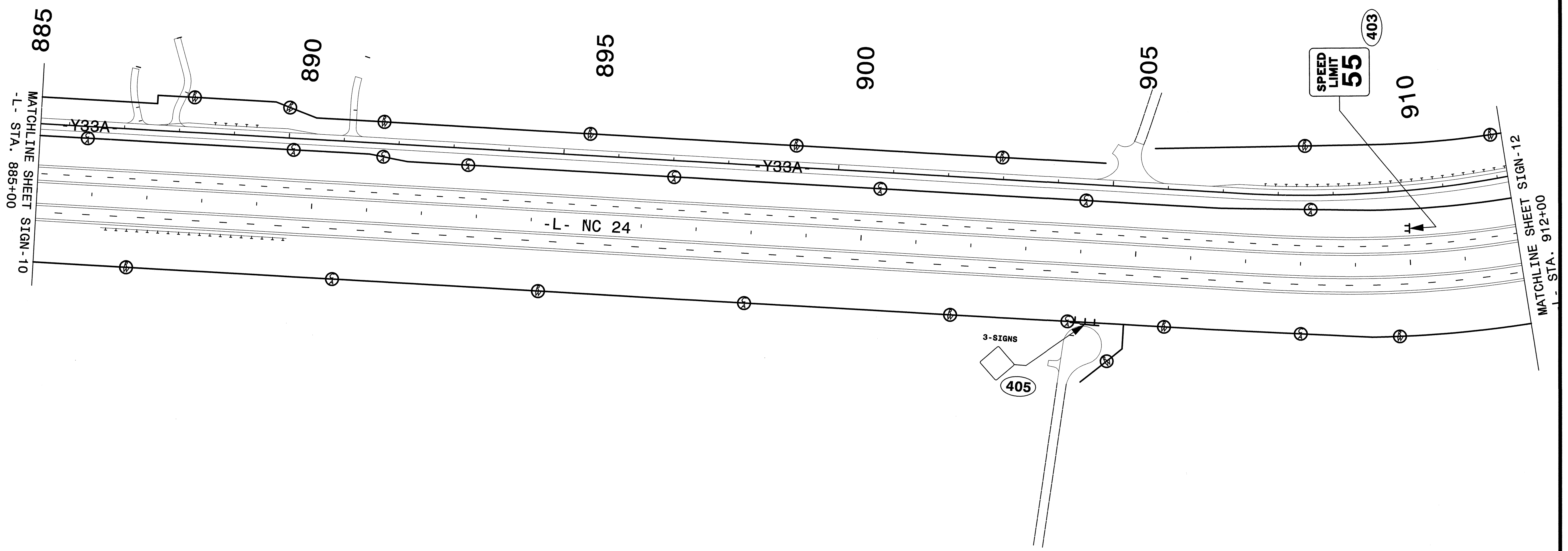
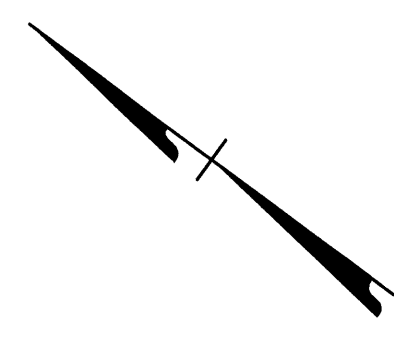
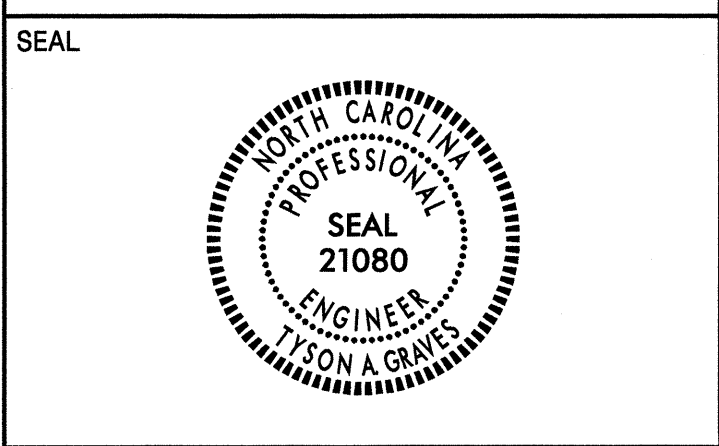

**PROJECT NOTES**

1 DISPOSAL OF SIGN SYSTEM, U-CHANNEL

**PROPOSED SIGNS**

2/16/2013  
 F:\Signing\Deireaction\R-2303C\Signing\2303c-sign-plan-SIGN-11.dgn  
 Florence & Hutcheson



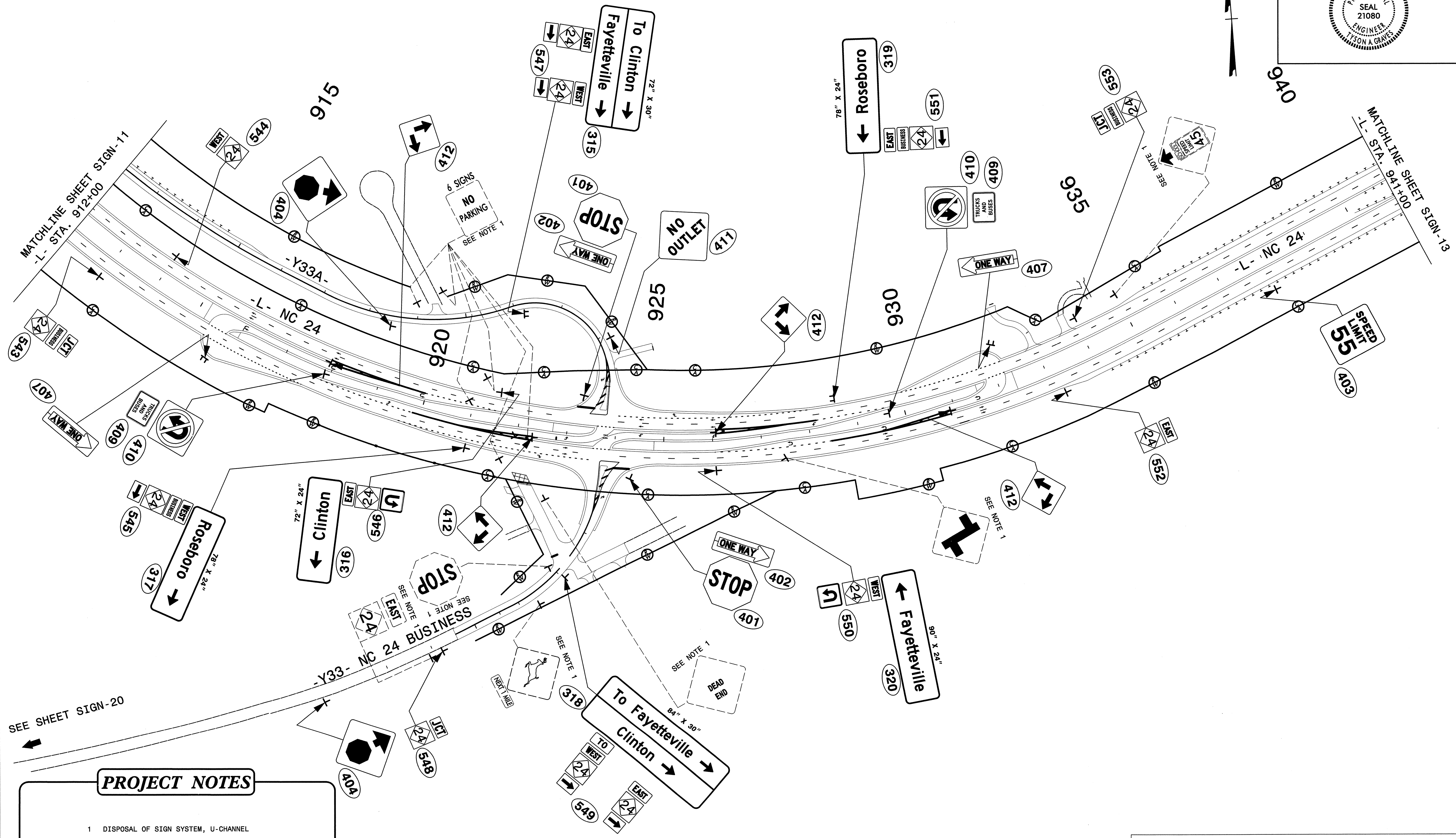

**PROJECT NOTES**

1 DISPOSAL OF SIGN SYSTEM, U-CHANNEL

**PROPOSED & EXISTING SIGNS**

2/16/2013  
 R:\S\Signing\Delin\nc24\Signing\2303c\sign-plan\_SIGN-12.dgn  
 Florence & Hutcheson



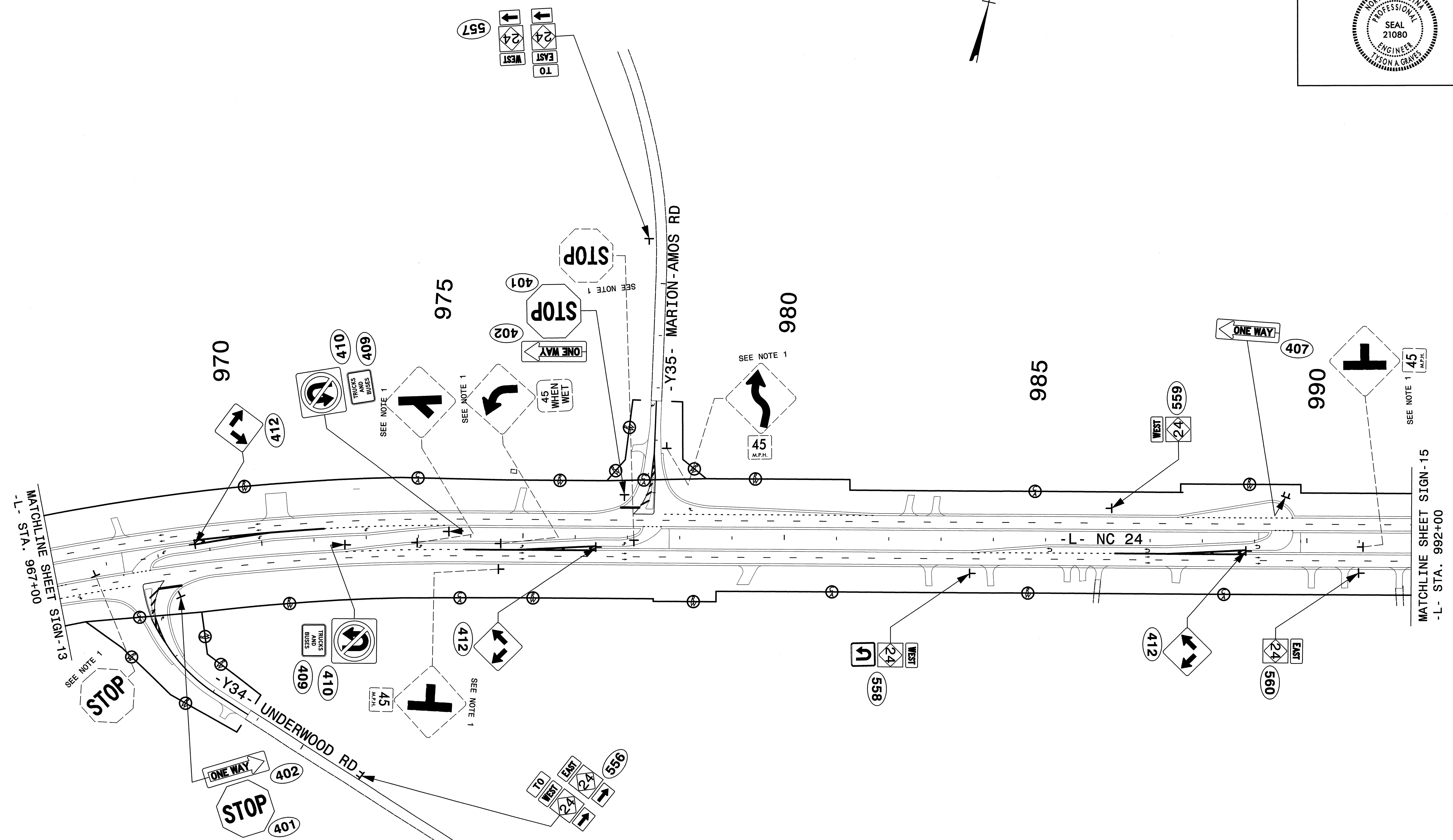

**PROJECT NOTES**

1 DISPOSAL OF SIGN SYSTEM, U-CHANNEL

**PROPOSED & EXISTING SIGNS**

2/16/2013  
 P:\S\Signing\Delimitation\R-2303C\Signing\Y-2303c-sign-plan-SIGN-14.dgn  
 Florence & Hutcheson

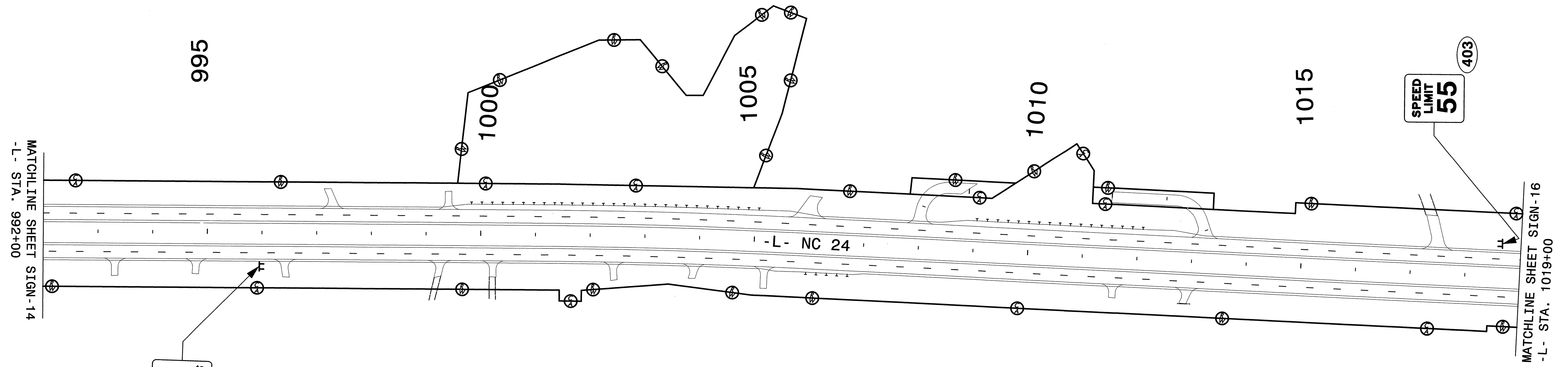
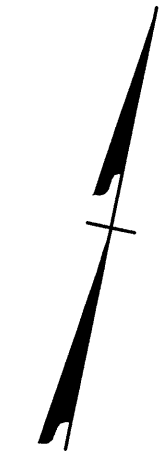

**PROJECT NOTES**

- 1 DISPOSAL OF SIGN SYSTEM, U-CHANNEL

**PROPOSED SIGNS**

2/16/2013  
 F:\Signing\Delinestation\R-2303C\Signing\R-2303c-sign-plan\_SIGN\_15.dgn  
 Florence & Hutcheson

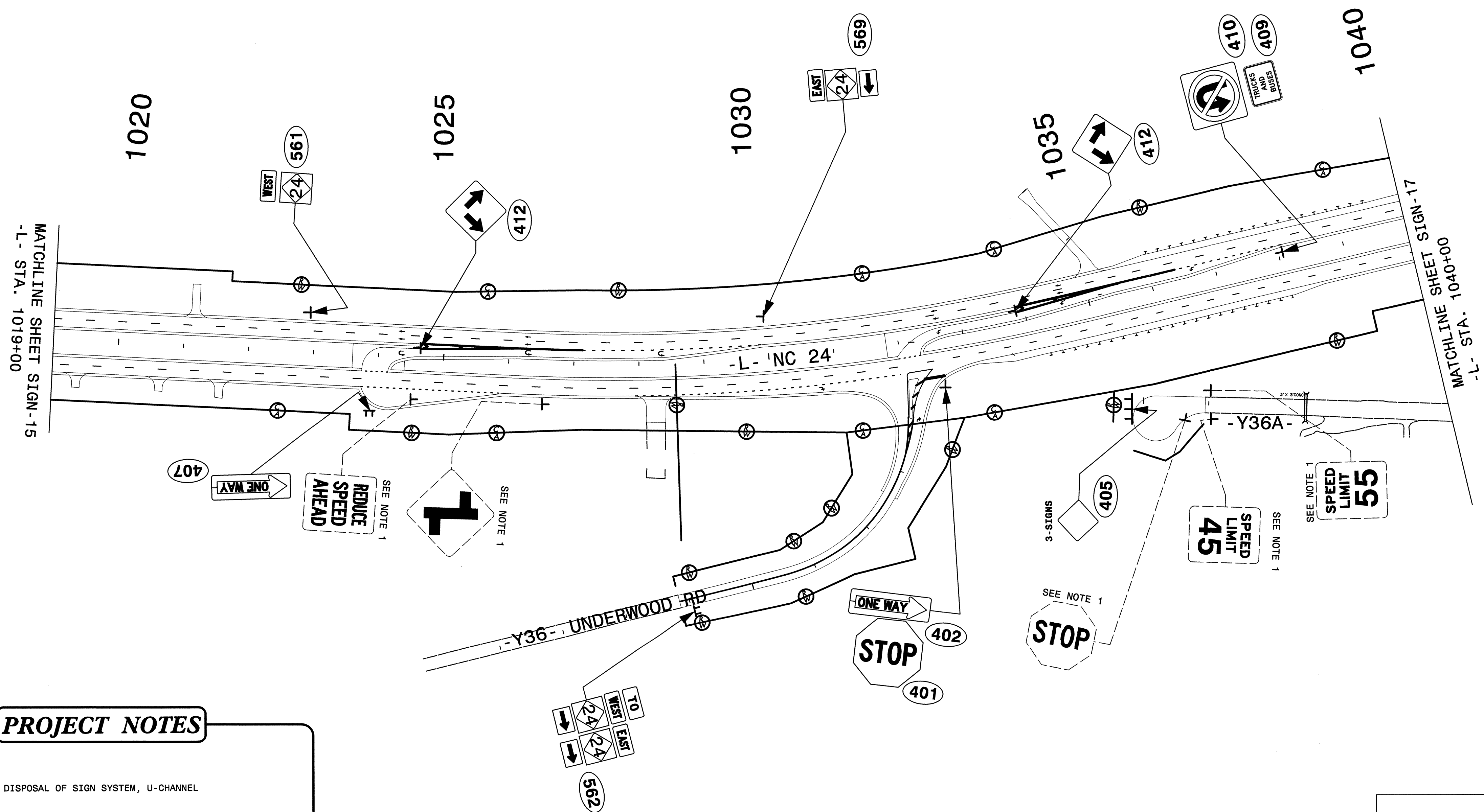

**PROJECT NOTES**

1 DISPOSAL OF SIGN SYSTEM, U-CHANNEL

**PROPOSED & EXISTING SIGNS**

2/16/2013  
 P:\Signing\DeLineation\R-2303C\Signing\2303c-sign-plan-SIGN-16.dgn  
 Florence & Hutcheson



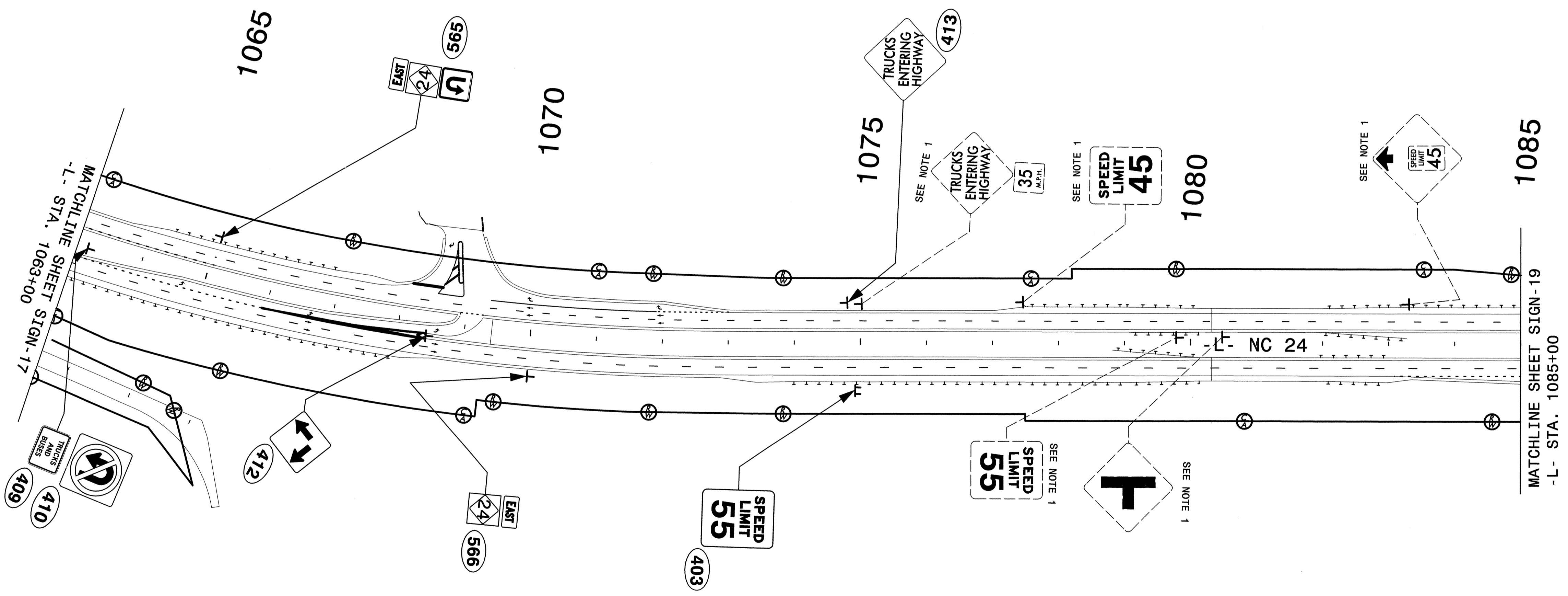
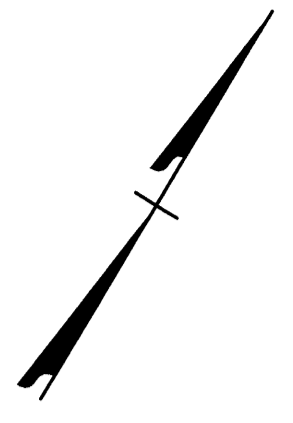
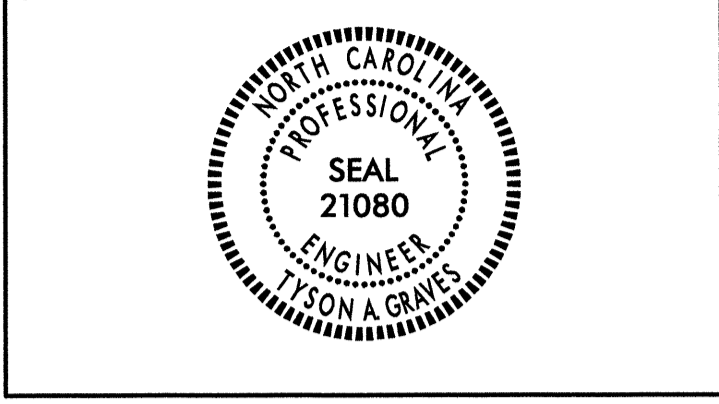

**PROJECT NOTES**

1 DISPOSAL OF SIGN SYSTEM, U-CHANNEL

**PROPOSED & EXISTING SIGNS**

2/16/2013  
 P:\Signing\Delinjection\2303C\Signing\2303c-sign-plan\_SIGN\_18.dgn  
 Florence & Hutcheson

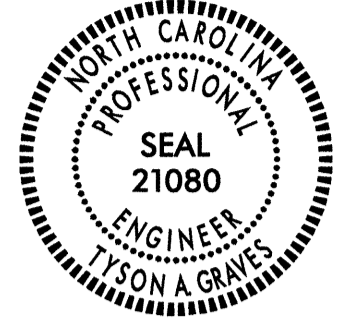

-L- STA. 1097+00.00  
 END SIGNING CONSTRUCTION  
 PROJECT R-2303C

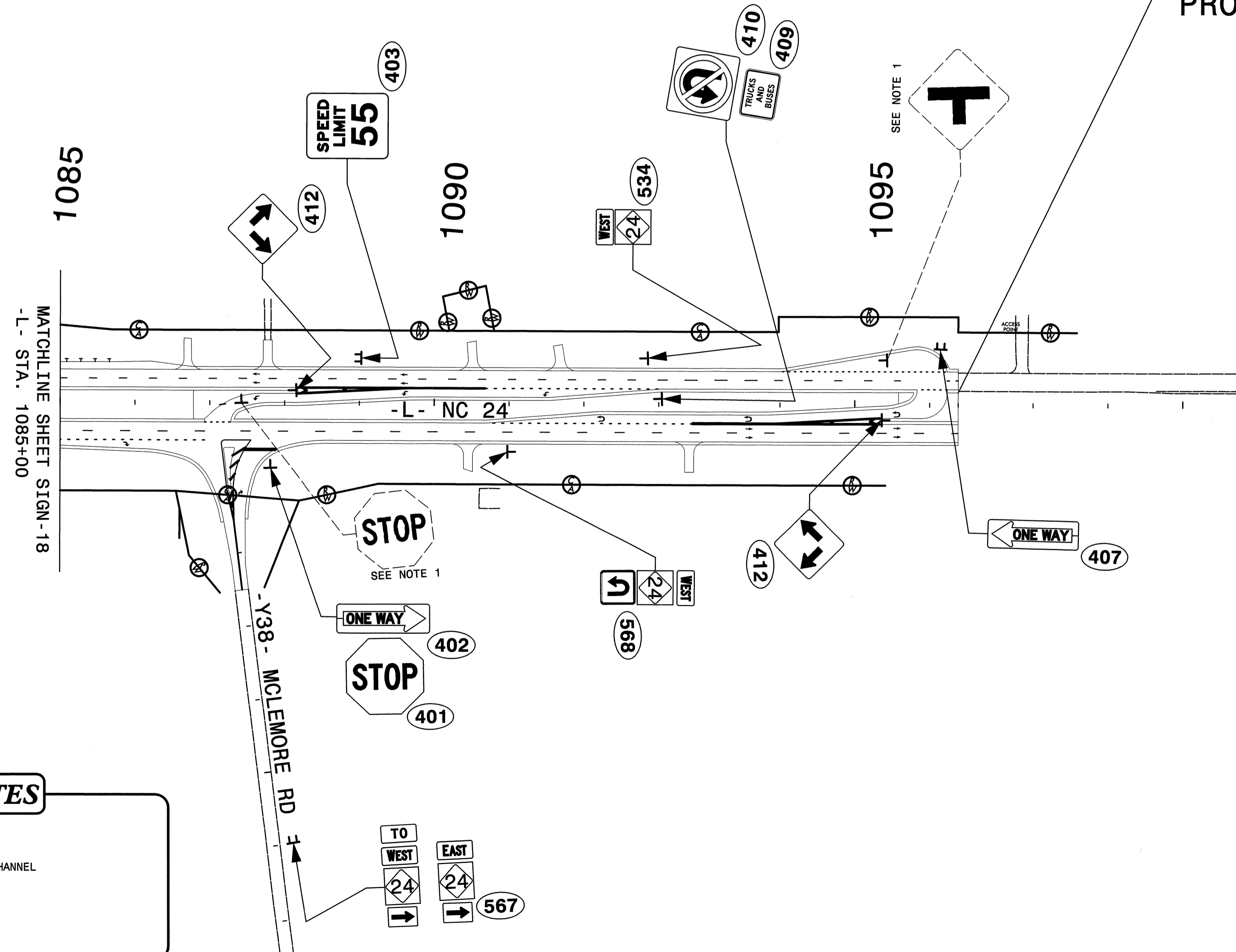

**PROJECT NOTES**

1 DISPOSAL OF SIGN SYSTEM, U-CHANNEL

**PROPOSED & EXISTING SIGNS**

2/16/2013  
 P:\Signing\Del\Ineation\1R-2303C\Signing\2303c-sign-plan\_SIGN-19.dgn  
 Florence & Hutcheson



APPROVED: *[Signature]*

DATE: 2-16-13

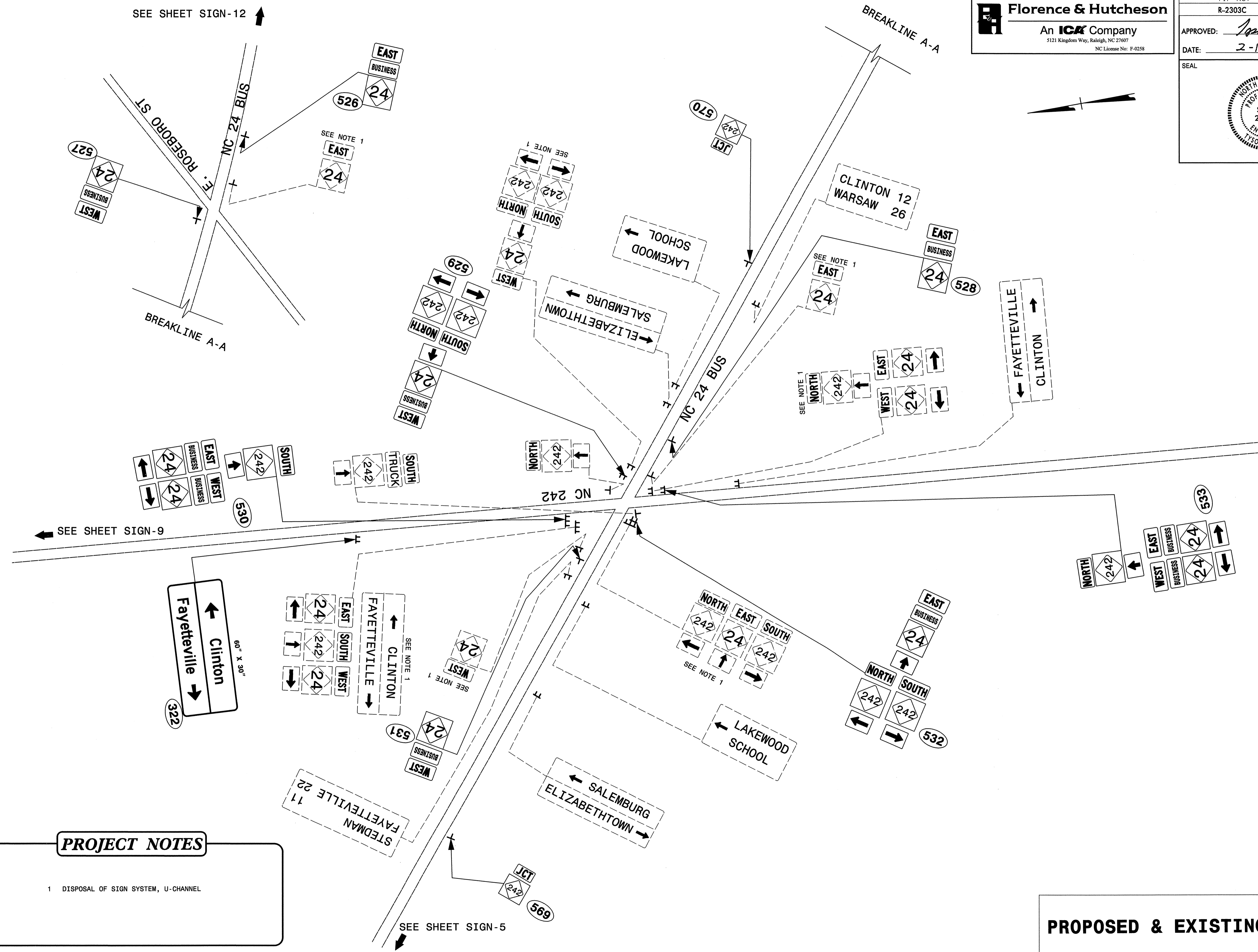
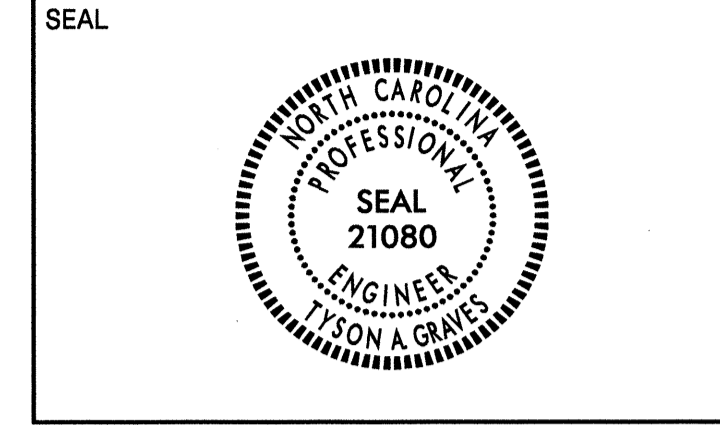

**PROJECT NOTES**

1 DISPOSAL OF SIGN SYSTEM, U-CHANNEL

**PROPOSED & EXISTING SIGNS**

2/20/2013  
 P:\Signing\Del\lineation\R-2303C\Signing\R-2303c-sign-pln-stn-20.dgn  
 Florence & Hutcheson