

DETAIL 'A'- DUAL CURB RAMPS

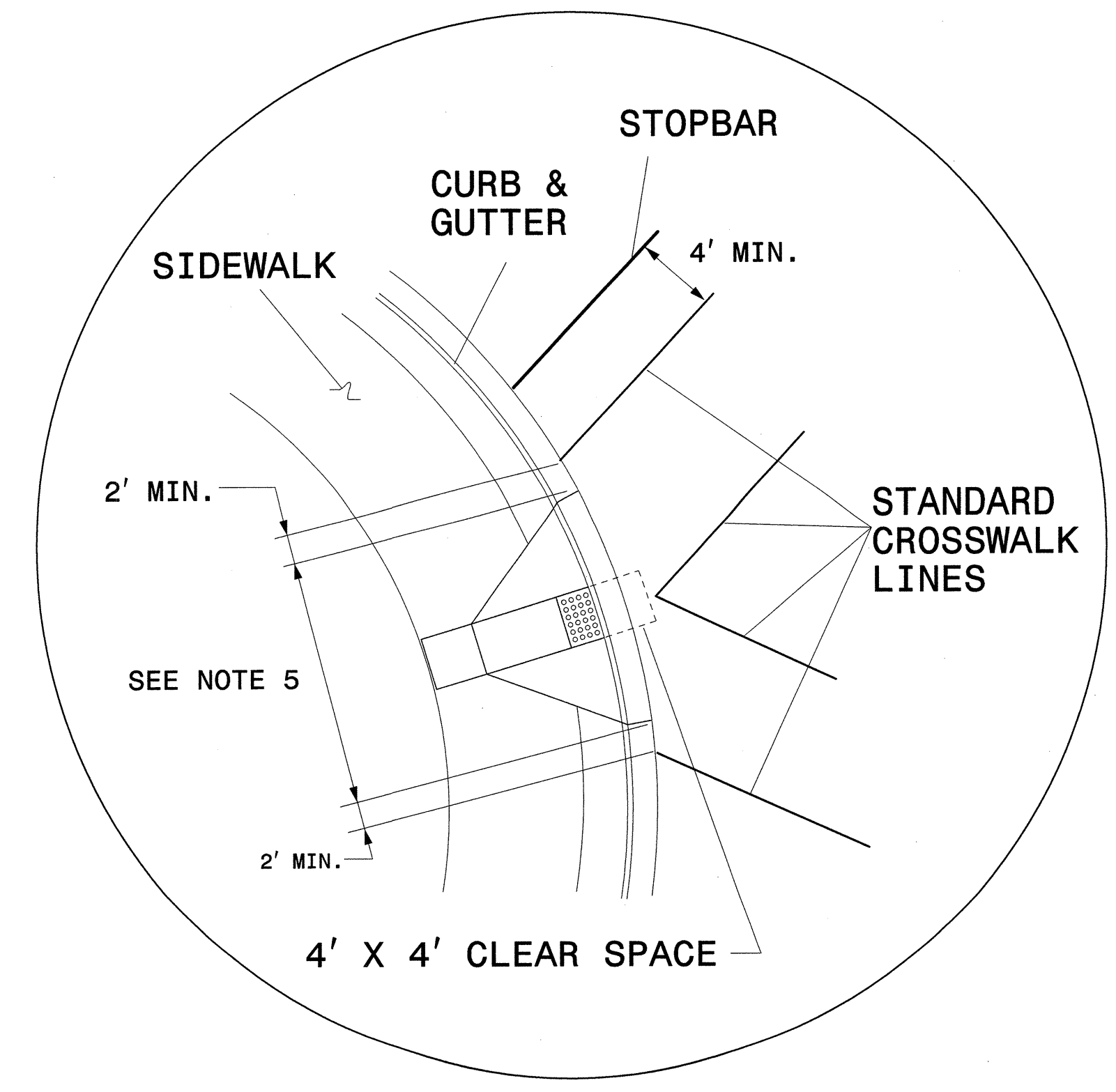

DETAIL 'B'- SINGLE DIAGONAL CURB RAMP

**GUIDANCE DETAIL FOR STANDARD AND HI-VISIBILITY CROSSWALKS AT SIGNALIZED OR STOP SIGN CONTROLLED INTERSECTIONS**

- NOTES:
- USE DETAILS ABOVE AND THE FOLLOWING NOTES FOR GUIDANCE IN PLACING CROSSWALKS AND STOP BARS NOT STATIONED ON THE DETAIL SHEETS OR WHEN FIELD ADJUSTMENTS REQUIRED MOVING STATIONED MARKINGS AS DIRECTED BY THE ENGINEER. REFER TO NCDOT ROADWAY STANDARD DRAWINGS, MUTCD AND ADA STANDARDS FOR ADDITIONAL GUIDANCE.
  - SET BACK DISTANCE FROM INSIDE CROSSWALK MARKING TO NEAREST EDGE OF TRAVEL IS 4' MIN.
  - BEYOND THE BOTTOM GRADE BRAKE, A CLEAR SPACE OF 4' X 4' MINIMUM SHALL BE PROVIDED WITHIN THE WIDTH OF THE CROSSWALK.
  - SINGLE DIAGONAL CURB RAMPS WITH FLARED SIDES SHALL HAVE A SEGMENT OF CURB 2 FEET LONG MINIMUM LOCATED ON EACH SIDE OF THE CURB RAMP AND WITHIN THE MARKED CROSSING, SEE DETAIL 'B'.
  - CURB RAMPS SHALL BE CONSTRUCTED IN ACCORDANCE TO THE LATEST NCDOT ROADWAY STANDARD DRAWINGS.

**CROSSWALK AND STOP BAR PAVEMENT MARKING DETAIL**

20-FEB-2013 18:51  
 O:\Transportation\Tiraffio\Curr\00030391R-2246B CL Pkwy SPM\PM\Revision Feb2013\PM-01B.dgn  
 AT RALCNU2252BLM  
 15637

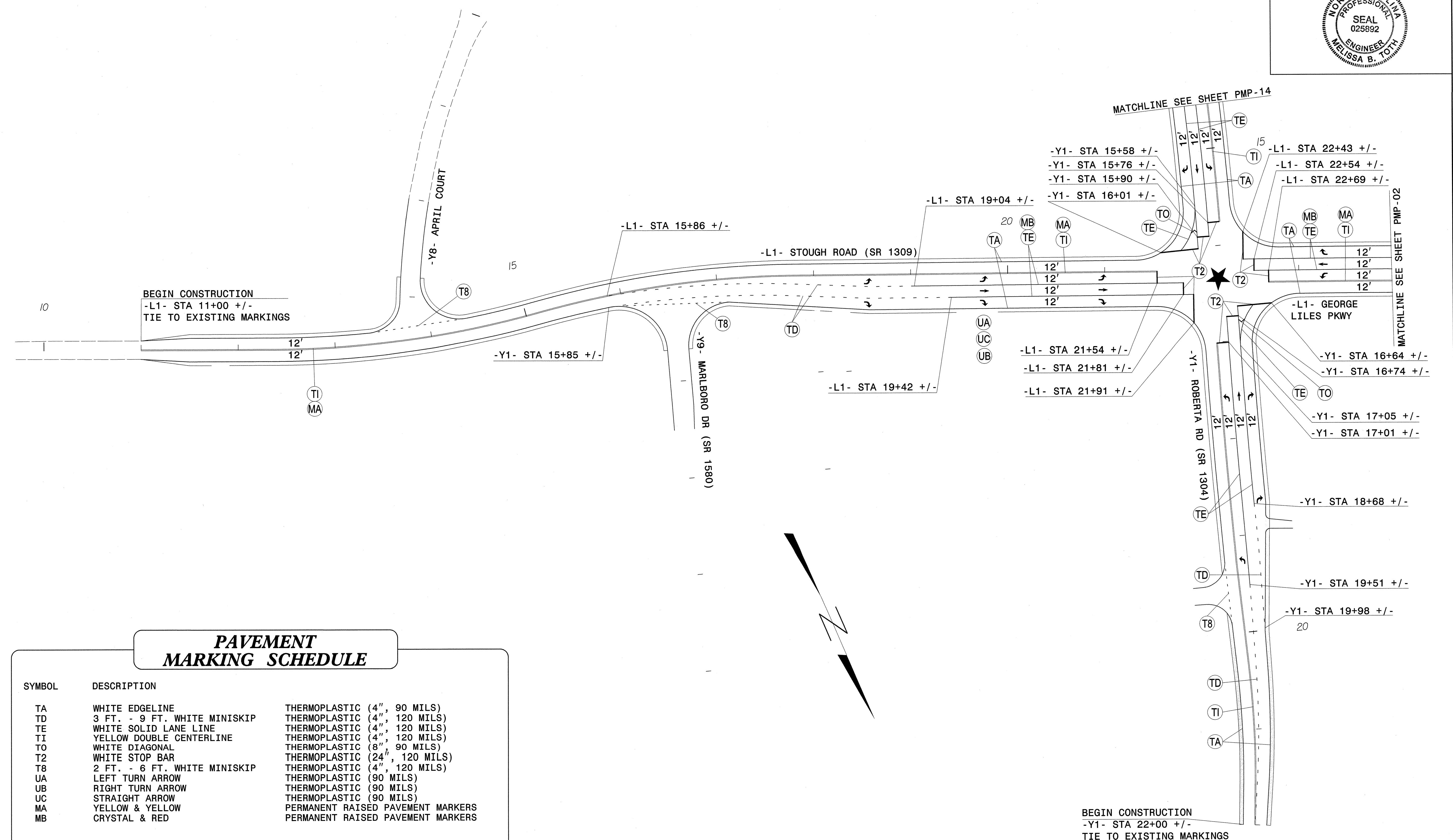

**PAVEMENT MARKING SCHEDULE**

SYMBOL	DESCRIPTION	
TA	WHITE EDGELINE	THERMOPLASTIC (4", 90 MILS)
TD	3 FT. - 9 FT. WHITE MINISKIP	THERMOPLASTIC (4", 120 MILS)
TE	WHITE SOLID LANE LINE	THERMOPLASTIC (4", 120 MILS)
TI	YELLOW DOUBLE CENTERLINE	THERMOPLASTIC (4", 120 MILS)
TO	WHITE DIAGONAL	THERMOPLASTIC (8", 90 MILS)
T2	WHITE STOP BAR	THERMOPLASTIC (24", 120 MILS)
T8	2 FT. - 6 FT. WHITE MINISKIP	THERMOPLASTIC (4", 120 MILS)
UA	LEFT TURN ARROW	THERMOPLASTIC (90 MILS)
UB	RIGHT TURN ARROW	THERMOPLASTIC (90 MILS)
UC	STRAIGHT ARROW	THERMOPLASTIC (90 MILS)
MA	YELLOW & YELLOW	PERMANENT RAISED PAVEMENT MARKERS
MB	CRYSTAL & RED	PERMANENT RAISED PAVEMENT MARKERS

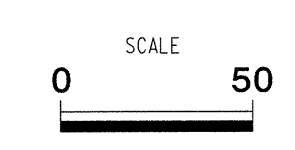

20-FEB-2013 19:36  
 O:\Transportation\Tiff\0030391R-2246B CL Pkwy SPM\PM\Revision Feb2013\PM\_01.dgn  
 AT RALCN2252BLM



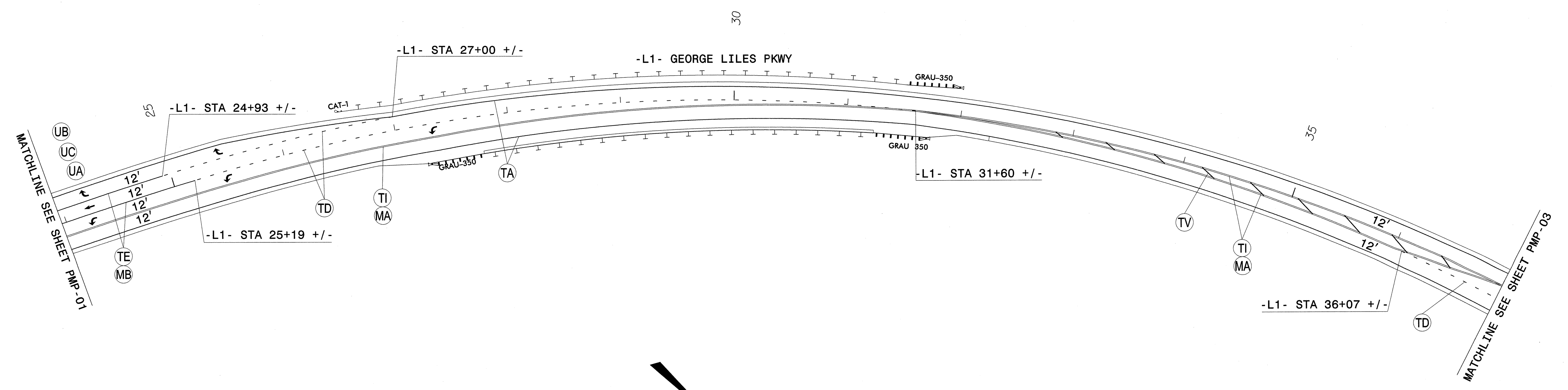

**PAVEMENT MARKING SCHEDULE**

SYMBOL	DESCRIPTION	
TA	WHITE EDGELINE	THERMOPLASTIC (4", 90 MILS)
TD	3 FT. - 9 FT. WHITE MINISKIP	THERMOPLASTIC (4", 120 MILS)
TE	WHITE SOLID LANE LINE	THERMOPLASTIC (4", 120 MILS)
TI	YELLOW DOUBLE CENTERLINE	THERMOPLASTIC (4", 120 MILS)
TV	YELLOW DIAGONAL	THERMOPLASTIC (12", 90 MILS)
UA	LEFT TURN ARROW	THERMOPLASTIC (90 MILS)
UB	RIGHT TURN ARROW	THERMOPLASTIC (90 MILS)
UC	STRAIGHT ARROW	THERMOPLASTIC (90 MILS)
MA	YELLOW & YELLOW	PERMANENT RAISED PAVEMENT MARKERS
MB	CRYSTAL & RED	PERMANENT RAISED PAVEMENT MARKERS

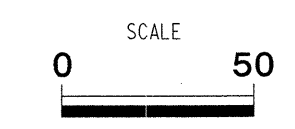

**ATKINS** 1616 EAST MILLBROOK ROAD, SUITE 310  
 RALEIGH, NORTH CAROLINA 27609  
 (919) 876-6888 NCBEES #F-0326

**PAVEMENT MARKING PLANS**  
**-L1- GEORGE LILES PKWY**

20-FEB-2013 19:36  
 05-ATFonspor\Tation\Traf\fic\Curr\00030391R-2246B GL Pkwy SPM\PM\Revision Feb2013\PM\_02.dgn  
 15637 AT RALCNU252BLM

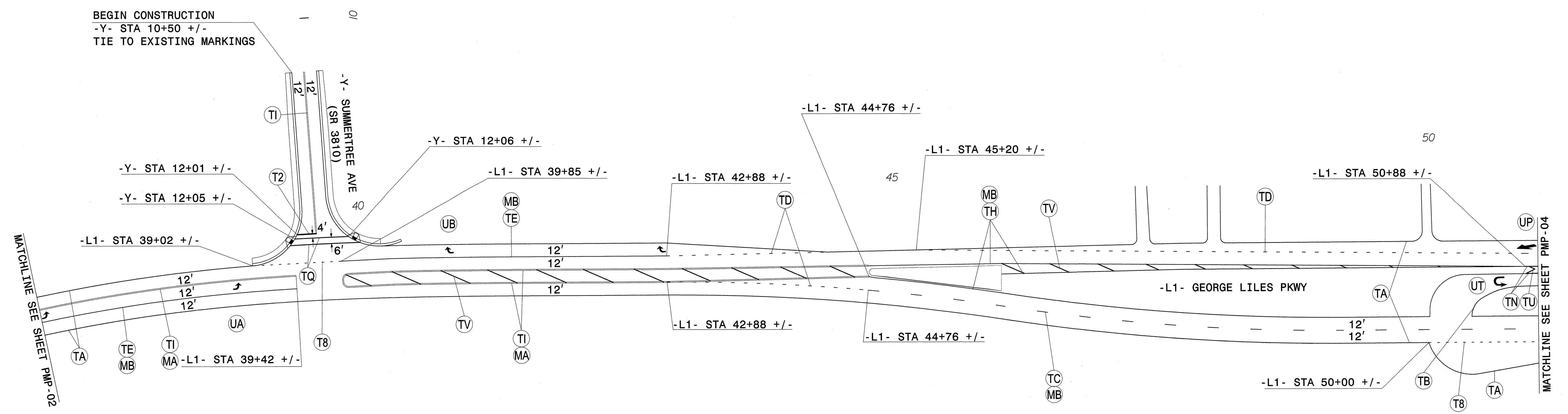
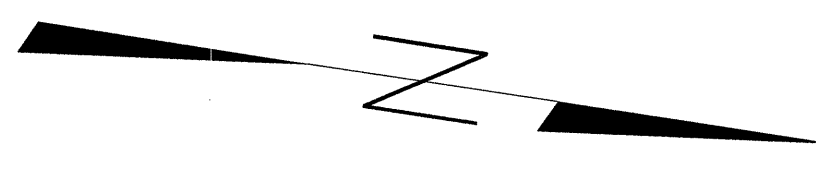

SYMBOL	DESCRIPTION	
TA	WHITE EDGELINE	THERMOPLASTIC (4", 90 MILS)
TB	YELLOW EDGE LINE	THERMOPLASTIC (4", 90 MILS)
TC	10 FT. WHITE SKIP	THERMOPLASTIC (4", 120 MILS)
TD	3 FT. - 9 FT. WHITE MINISKIP	THERMOPLASTIC (4", 120 MILS)
TE	WHITE SOLID LANE LINE	THERMOPLASTIC (4", 120 MILS)
TH	YELLOW SINGLE CENTERLINE	THERMOPLASTIC (4", 120 MILS)
TI	YELLOW DOUBLE CENTERLINE	THERMOPLASTIC (4", 120 MILS)
TN	WHITE GORE LINE	THERMOPLASTIC (8", 90 MILS)
TQ	WHITE CROSSWALK LINE	THERMOPLASTIC (8", 120 MILS)
TU	WHITE DIAGONAL	THERMOPLASTIC (12", 90 MILS)
TV	YELLOW DIAGONAL	THERMOPLASTIC (12", 90 MILS)
T2	WHITE STOP BAR	THERMOPLASTIC (24", 120 MILS)
T8	2 FT. - 6 FT. WHITE MINISKIP	THERMOPLASTIC (4", 120 MILS)
UA	LEFT TURN ARROW	THERMOPLASTIC (90 MILS)
UB	RIGHT TURN ARROW	THERMOPLASTIC (90 MILS)
UP	MERGE ARROW	THERMOPLASTIC (90 MILS)
UT	U-TURN ARROW	THERMOPLASTIC (90 MILS)
MA	YELLOW & YELLOW	PERMANENT RAISED PAVEMENT MARKERS
MB	CRYSTAL & RED	PERMANENT RAISED PAVEMENT MARKERS

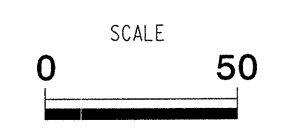

**ATKINS** 1616 EAST MILLBROOK ROAD, SUITE 310  
 RALEIGH, NORTH CAROLINA 27609  
 (919) 876-6888 NCBEES #F-0326

**PAVEMENT MARKING PLANS**  
 -L1- GEORGE LILES PKWY

20-FEB-2013 10:47  
 G:\ATKINS\Projects\Traffic\Curf\00030391R-2246B CL Pkwy SPM\PM\Revision Feb2013\PM\_03.dgn  
 5637 AT RAL CNU2252BLM

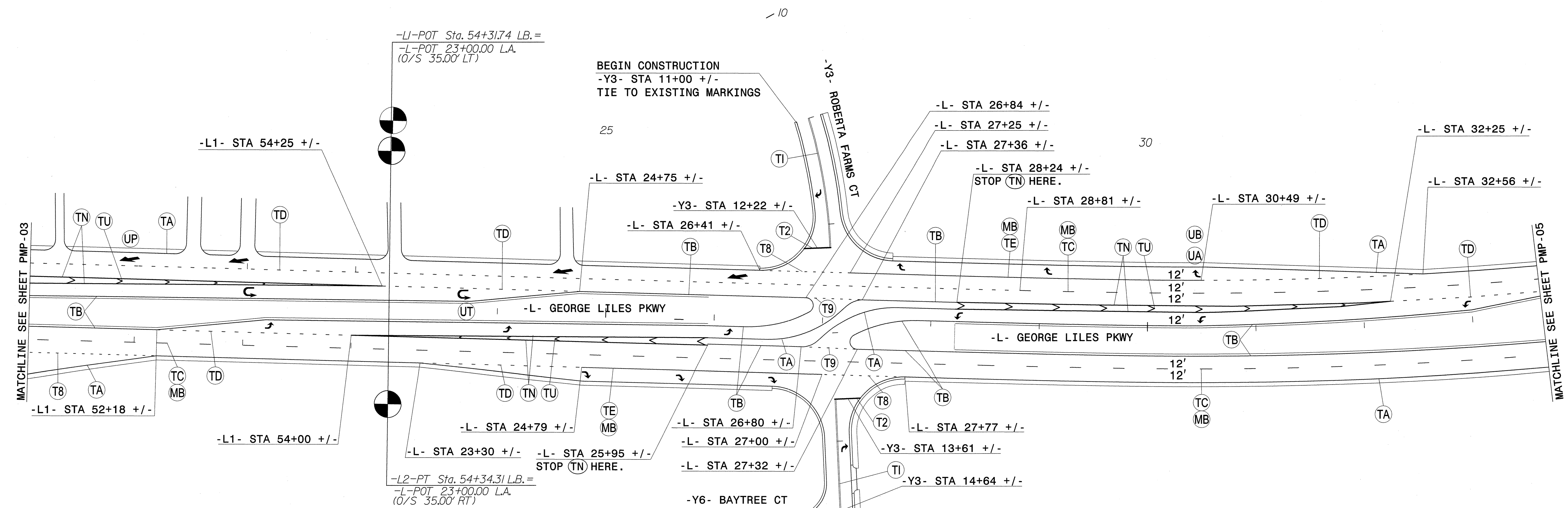

**PAVEMENT MARKING SCHEDULE**

SYMBOL	DESCRIPTION	
TA	WHITE EDGE LINE	THERMOPLASTIC (4", 90 MILS)
TB	YELLOW EDGE LINE	THERMOPLASTIC (4", 90 MILS)
TC	10 FT. WHITE SKIP	THERMOPLASTIC (4", 120 MILS)
TD	3 FT. - 9 FT. WHITE MINISKIP	THERMOPLASTIC (4", 120 MILS)
TE	WHITE SOLID LANE LINE	THERMOPLASTIC (4", 120 MILS)
TI	YELLOW DOUBLE CENTERLINE	THERMOPLASTIC (4", 120 MILS)
TN	WHITE GORE LINE	THERMOPLASTIC (8", 90 MILS)
TU	WHITE DIAGONAL	THERMOPLASTIC (12", 90 MILS)
T2	WHITE STOP BAR	THERMOPLASTIC (24", 120 MILS)
T8	2 FT. - 6 FT. WHITE MINISKIP	THERMOPLASTIC (4", 120 MILS)
T9	2 FT. - 6 FT. YELLOW MINISKIP	THERMOPLASTIC (4", 120 MILS)
UA	LEFT TURN ARROW	THERMOPLASTIC (90 MILS)
UB	RIGHT TURN ARROW	THERMOPLASTIC (90 MILS)
UP	MERGE ARROW	THERMOPLASTIC (90 MILS)
UT	U-TURN ARROW	THERMOPLASTIC (90 MILS)
MB	CRYSTAL & RED	PERMANENT RAISED PAVEMENT MARKERS

-Y6- END CONSTRUCTION  
TIE TO EXISTING MARKINGS

END CONSTRUCTION  
-Y3- STA 16+00 +/-  
TIE TO EXISTING MARKINGS

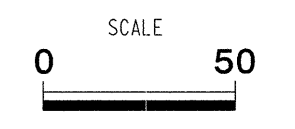

**ATKINS** 1616 EAST MILLBROOK ROAD, SUITE 310  
RALEIGH, NORTH CAROLINA 27609  
(919) 876-6888 NCBEES #F-0326

**PAVEMENT MARKING PLANS**  
**-L1- GEORGE LILES PKWY**

20-FEB-2013 19:34  
G:\transportation\Irrigation\Curr\00030391R-2246B 0L Pkwy SPMA\PM\Revision Feb2013\PM-04.dgn  
15637 AT RALCNU252BLM

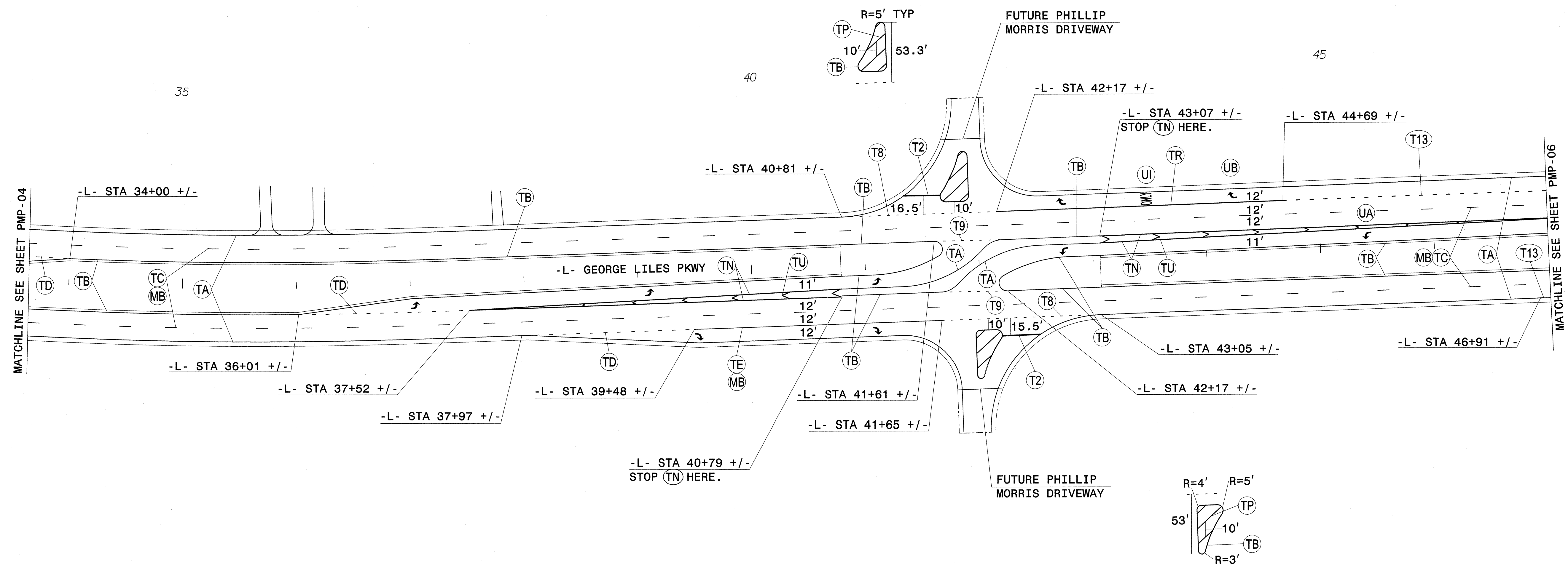
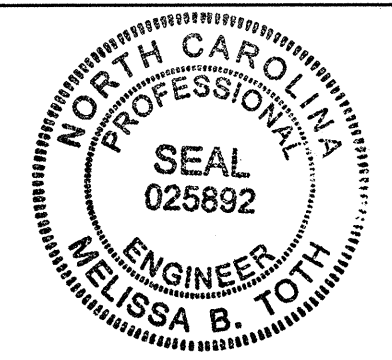

**PAVEMENT MARKING SCHEDULE**

SYMBOL	DESCRIPTION	
TA	WHITE EDGELINE	THERMOPLASTIC (4", 90 MILS)
TB	YELLOW EDGE LINE	THERMOPLASTIC (4", 90 MILS)
TC	10 FT. WHITE SKIP	THERMOPLASTIC (4", 120 MILS)
TD	3 FT. - 9 FT. WHITE MINISKIP	THERMOPLASTIC (4", 120 MILS)
TE	WHITE SOLID LANE LINE	THERMOPLASTIC (4", 120 MILS)
TN	WHITE GORE LINE	THERMOPLASTIC (8", 90 MILS)
TP	YELLOW DIAGONAL	THERMOPLASTIC (8", 90 MILS)
TR	WHITE SOLID LANE LINE	THERMOPLASTIC (8", 120 MILS)
TU	WHITE DIAGONAL	THERMOPLASTIC (12", 90 MILS)
T2	WHITE STOP BAR	THERMOPLASTIC (24", 120 MILS)
T8	2 FT. - 6 FT. WHITE MINISKIP	THERMOPLASTIC (4", 120 MILS)
T9	2 FT. - 6 FT. YELLOW MINISKIP	THERMOPLASTIC (4", 120 MILS)
T13	3 FT. - 9 FT. WHITE MINISKIP	THERMOPLASTIC (8", 120 MILS)
UA	LEFT TURN ARROW	THERMOPLASTIC (90 MILS)
UB	RIGHT TURN ARROW	THERMOPLASTIC (90 MILS)
UI	ALPHANUMERIC CHARACTERS	THERMOPLASTIC (120 MILS)
MB	CRYSTAL & RED	PERMANENT RAISED PAVEMENT MARKERS

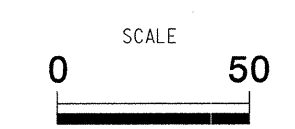

**ATKINS** 1616 EAST MILLBROOK ROAD, SUITE 310  
 RALEIGH, NORTH CAROLINA 27609  
 (919) 876-6888 NCBEES #F-0326

**PAVEMENT MARKING PLANS**  
 -L- GEORGE LILES PKWY

20-FEB-2013 18:51  
 O:\Transportation\Traffic\Curr\100030391R-2246B GL Pkwy SPM\PM\Revision Feb2013\PM\_05.dgn  
 15637 AT RALCNU2252BLM



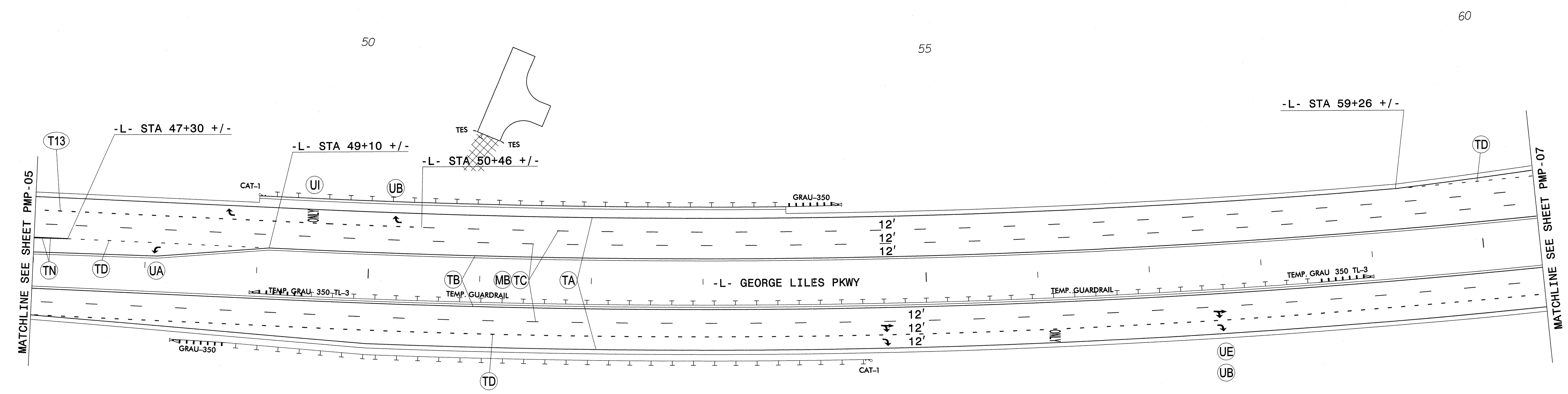

PAVEMENT MARKING SCHEDULE		
SYMBOL	DESCRIPTION	
TA	WHITE EDGELINE	THERMOPLASTIC (4", 90 MILS)
TB	YELLOW EDGE LINE	THERMOPLASTIC (4", 90 MILS)
TC	10 FT. WHITE SKIP	THERMOPLASTIC (4", 120 MILS)
TD	3 FT. - 9 FT. WHITE MINISKIP	THERMOPLASTIC (4", 120 MILS)
TN	WHITE GORE LINE	THERMOPLASTIC (8", 90 MILS)
T13	3 FT. - 9 FT. WHITE MINISKIP	THERMOPLASTIC (8", 120 MILS)
UA	LEFT TURN ARROW	THERMOPLASTIC (90 MILS)
UB	RIGHT TURN ARROW	THERMOPLASTIC (90 MILS)
UE	COMBO. STRAIGHT/RIGHT ARROW	THERMOPLASTIC (90 MILS)
UI	ALPHANUMERIC CHARACTERS	THERMOPLASTIC (120 MILS)
MB	CRYSTAL & RED	PERMANENT RAISED PAVEMENT MARKERS

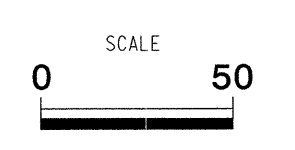
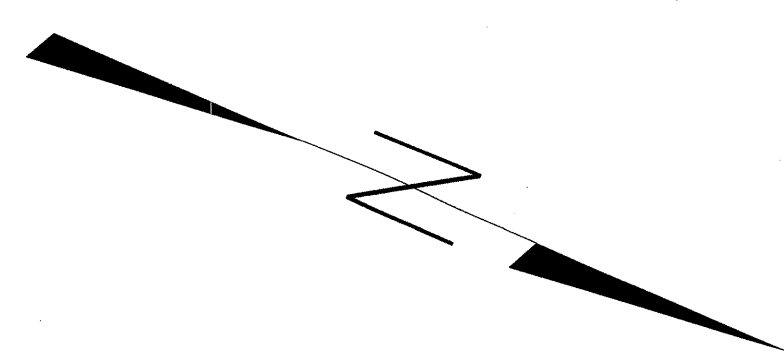

**ATKINS** 1616 EAST MILLBROOK ROAD, SUITE 310  
 RALEIGH, NORTH CAROLINA 27609  
 (919) 876-6888 NCBES #F-0326

**PAVEMENT MARKING PLANS**  
**-L1- GEORGE LILES PKWY**

20-FEB-2013 10:32  
 G:\Transportation\Traffic\00030391R-2246B CL Pkwy SPM\PM\Revision Feb2013\PM\_06.dgn  
 AT RALCNU2252BLM





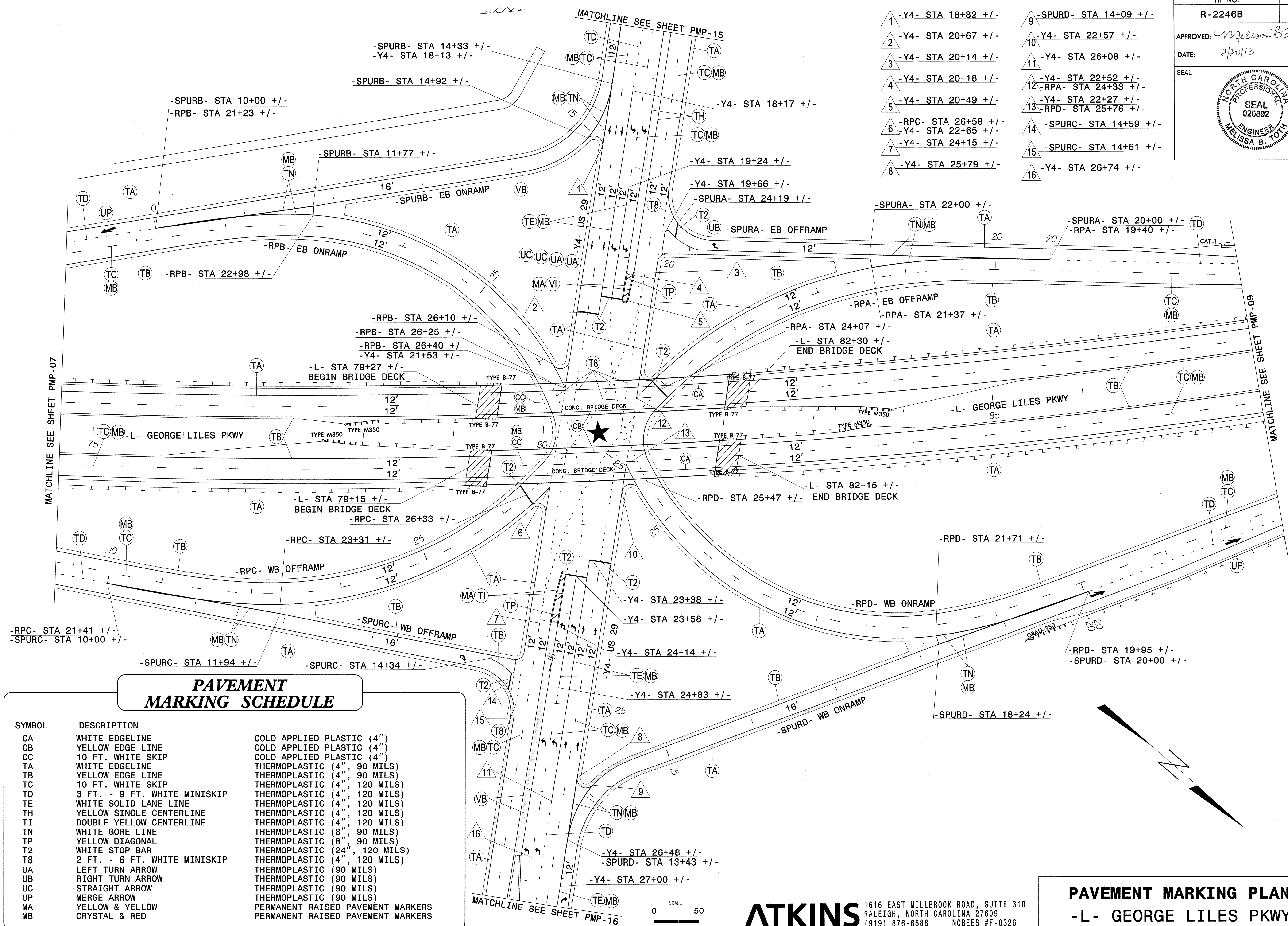

20-FEB-2013 18:51  
 G:\Transportation\Traffic\Cur\100030391R-2246B GL Pkwy SPMA\PA\Revision Feb2013\PLM08.dgn  
 15637 AT RALCNU2252BLM

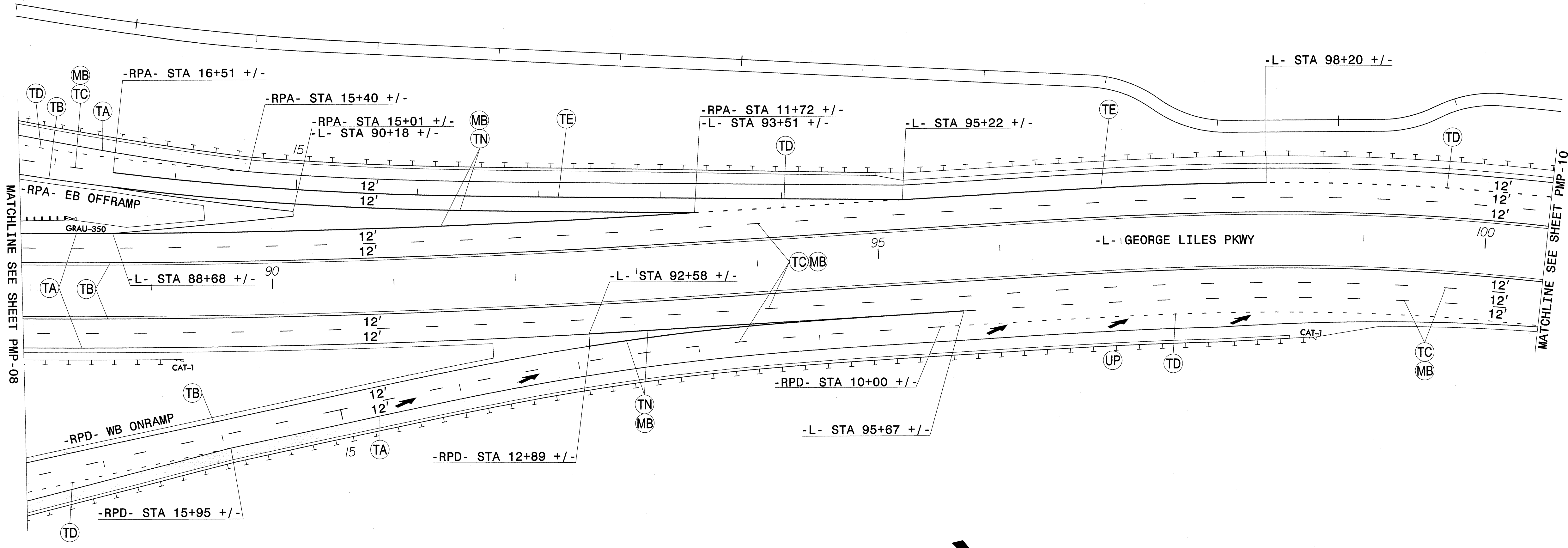

**PAVEMENT MARKING SCHEDULE**

SYMBOL	DESCRIPTION	
TA	WHITE EDGELINE	THERMOPLASTIC (4", 90 MILS)
TB	YELLOW EDGE LINE	THERMOPLASTIC (4", 90 MILS)
TC	10 FT. WHITE SKIP	THERMOPLASTIC (4", 120 MILS)
TD	3 FT. - 9 FT. WHITE MINISKIP	THERMOPLASTIC (4", 90 MILS)
TN	WHITE GORE LINE	THERMOPLASTIC (8", 90 MILS)
UP	MERGE ARROW	THERMOPLASTIC (90 MILS)
MB	CRYSTAL & RED	PERMANENT RAISED PAVEMENT MARKERS

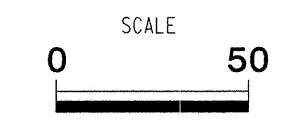

**ATKINS** 1616 EAST MILLBROOK ROAD, SUITE 310  
 RALEIGH, NORTH CAROLINA 27609  
 (919) 876-6888 NCBEES #F-0326

**PAVEMENT MARKING PLANS**  
 -L- GEORGE LILES PKWY

20-FEB-2013 18:51  
 O:\Information\Traffic\Curr\00030391R-2246B 0L Pkwy SPM\PM\Revision Feb2013\PM\_09.dgn  
 AT RALCNU2252BLM



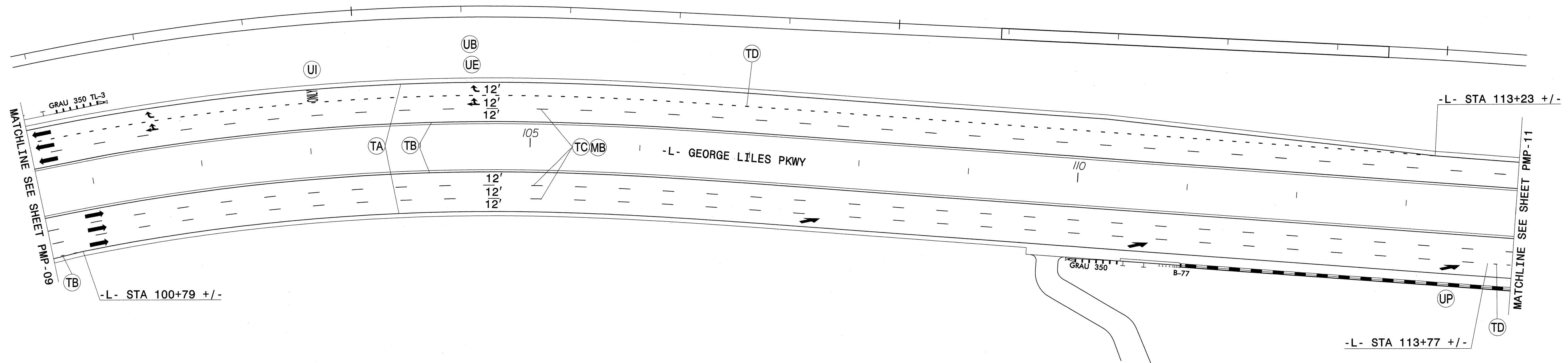

**PAVEMENT MARKING SCHEDULE**

SYMBOL	DESCRIPTION	
TA	WHITE EDGELINE	THERMOPLASTIC (4", 90 MILS)
TB	YELLOW EDGE LINE	THERMOPLASTIC (4", 90 MILS)
TC	10 FT. WHITE SKIP	THERMOPLASTIC (4", 120 MILS)
TD	3 FT. - 9 FT. WHITE MINISKIP	THERMOPLASTIC (4", 120 MILS)
UB	RIGHT ARROW	THERMOPLASTIC (90 MILS)
UE	COMBO. STRAIGHT / RIGHT ARROW	THERMOPLASTIC (90 MILS)
UI	ALPHANUMERIC CHARACTERS	THERMOPLASTIC (120 MILS)
UP	MERGE ARROW	THERMOPLASTIC (90 MILS)
MB	CRYSTAL & RED	PERMANENT RAISED PAVEMENT MARKERS

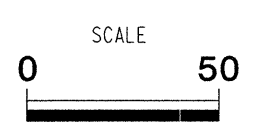
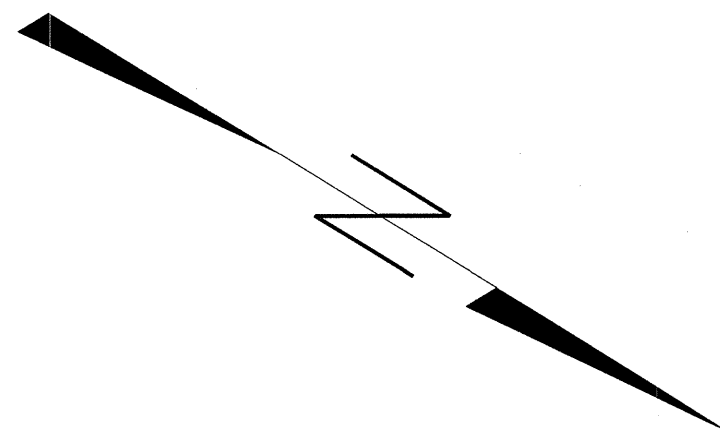

**ATKINS** 1616 EAST MILLBROOK ROAD, SUITE 310  
 RALEIGH, NORTH CAROLINA 27609  
 (919) 876-6888 NCBEES #F-0326

**PAVEMENT MARKING PLANS**  
 -L- GEORGE LILES PKWY

20-FEB-2013 19:30  
 O:\T\onspor\atkins\tr\office\curr\00030391R-2246B GL Pkwy SPM\PM\Revision Feb2013\PM\_10.dgn  
 15837 AT RALCNU2252BLM

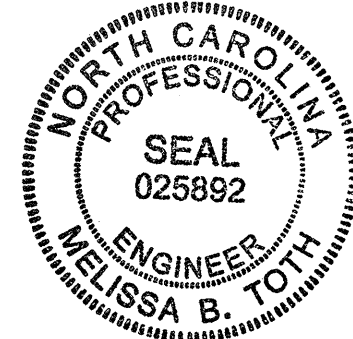
TIP NO. R-2246B	SHEET NO. PMP-11
APPROVED: <i>Melissa B. Toth</i>	
DATE: <i>2/20/13</i>	
SEAL	
	

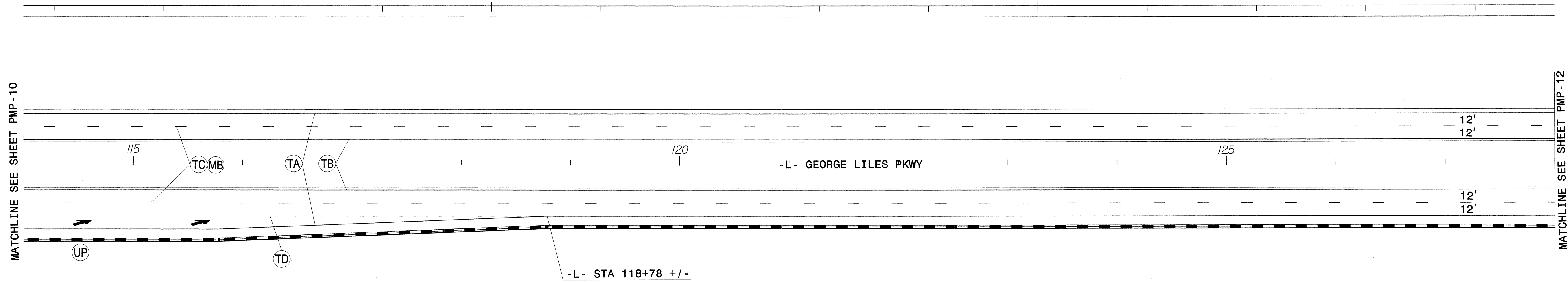

**PAVEMENT MARKING SCHEDULE**

SYMBOL	DESCRIPTION	
TA	WHITE EDGELINE	THERMOPLASTIC (4", 90 MILS)
TB	YELLOW EDGE LINE	THERMOPLASTIC (4", 90 MILS)
TC	10 FT. WHITE SKIP	THERMOPLASTIC (4", 120 MILS)
TD	3 FT. - 9 FT. WHITE MINISKIP	THERMOPLASTIC (4", 120 MILS)
UP	MERGE ARROW	THERMOPLASTIC (90 MILS)
MB	CRYSTAL & RED	PERMANENT RAISED PAVEMENT MARKERS

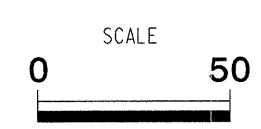
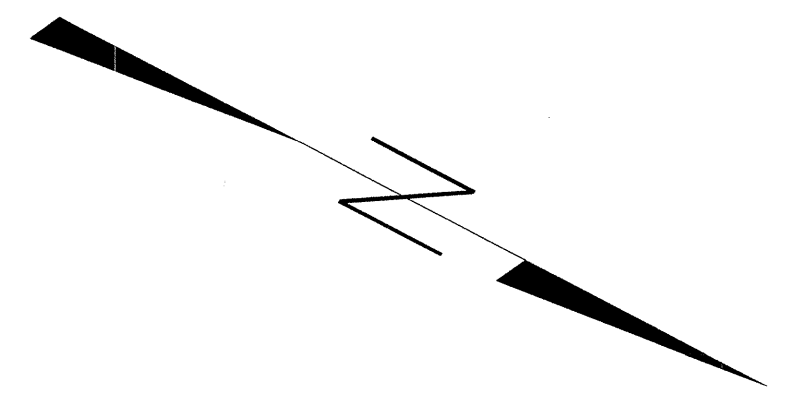

**ATKINS** 1616 EAST MILLBROOK ROAD, SUITE 310  
 RALEIGH, NORTH CAROLINA 27609  
 (919) 876-6888 NCBES #F-0326

**PAVEMENT MARKING PLANS**  
 -L- GEORGE LILES PKWY

20-FEB-2013 19:28  
 G:\Transportation\Trafic\Office\Curr\00030391R-2246B GL Pkwy SPM\PM\Revision Feb2013\PM\_IL.dgn  
 15637 AT RALONU225BLM

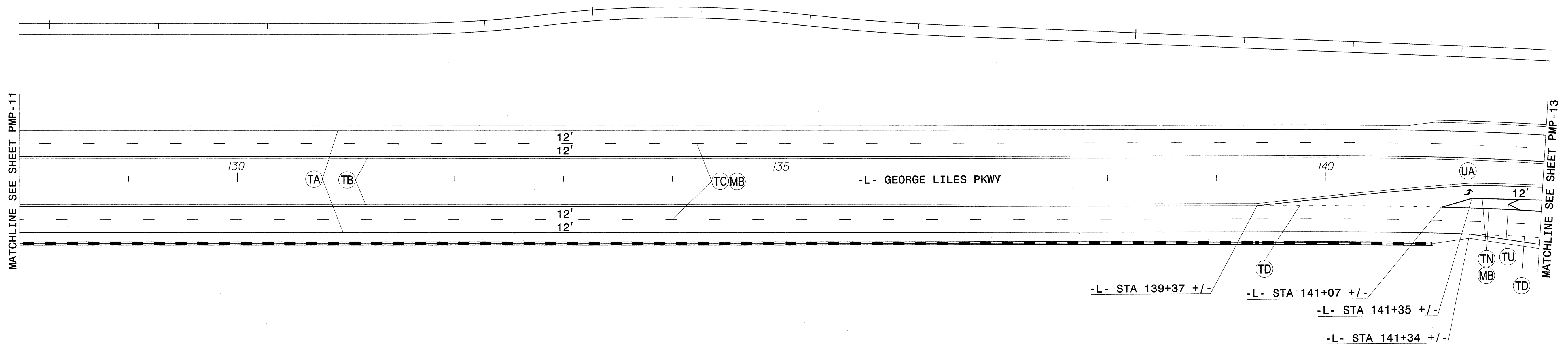

PAVEMENT MARKING SCHEDULE		
SYMBOL	DESCRIPTION	
TA	WHITE EDGELINE	THERMOPLASTIC (4", 90 MILS)
TB	YELLOW EDGE LINE	THERMOPLASTIC (4", 90 MILS)
TC	10 FT. WHITE SKIP	THERMOPLASTIC (4", 120 MILS)
TD	3 FT. - 9 FT. WHITE MINISKIP	THERMOPLASTIC (4", 120 MILS)
TN	WHITE GORE LINE	THERMOPLASTIC (8", 90 MILS)
TU	WHITE DIAGONAL	THERMOPLASTIC (12", 90 MILS)
UA	LEFT TURN ARROW	THERMOPLASTIC (90 MILS)
MB	CRYSTAL & RED	PERMANENT RAISED PAVEMENT MARKERS

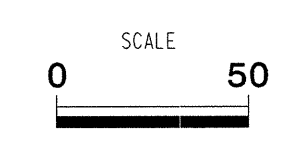
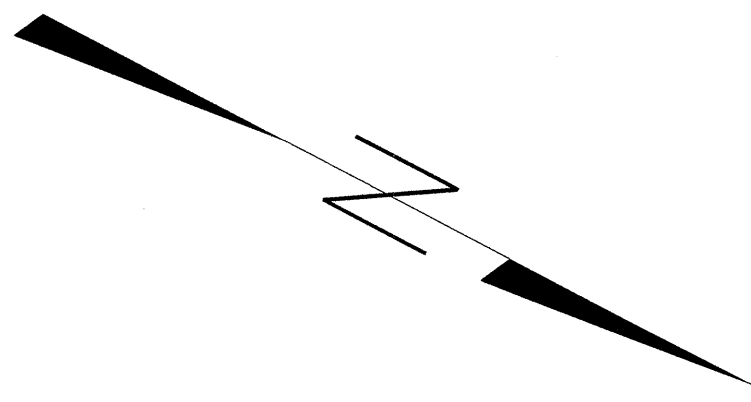

**ATKINS** 1616 EAST MILLBROOK ROAD, SUITE 310  
 RALEIGH, NORTH CAROLINA 27609  
 (919) 876-6888 NCBEES #F-0326

**PAVEMENT MARKING PLANS**  
 -L- GEORGE LILES PKWY

20-FEB-2013 19:27  
 G:\Transportation\Traffic\Current\00030391R-2246B GL Pkwy SPM\PM\Revision Feb2013\PM.L2.dgn  
 15637 AT RALCNU2252BLM



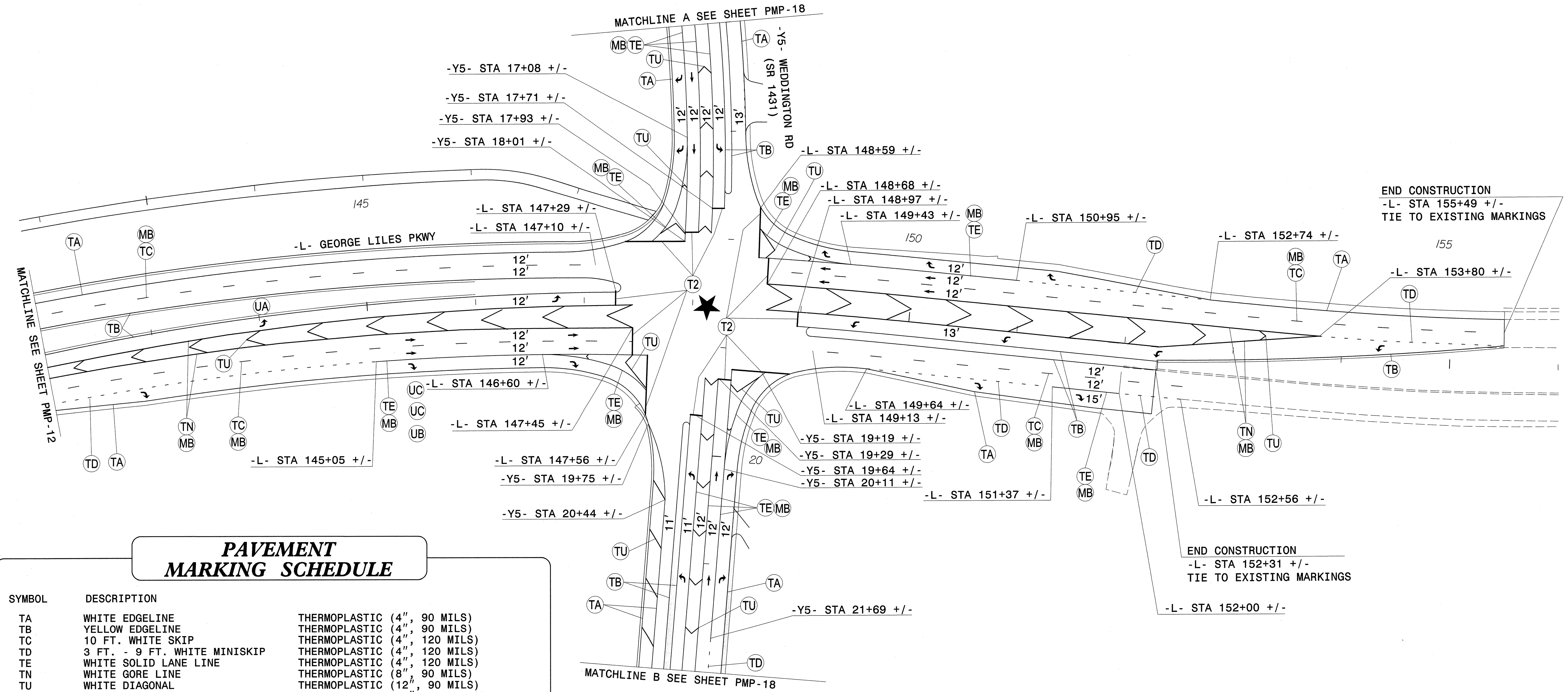
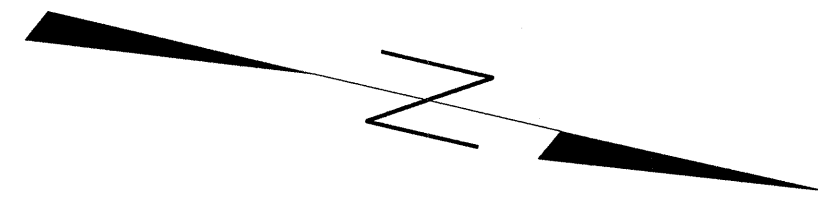

PAVEMENT MARKING SCHEDULE		
SYMBOL	DESCRIPTION	
TA	WHITE EDGELINE	THERMOPLASTIC (4", 90 MILS)
TB	YELLOW EDGELINE	THERMOPLASTIC (4", 90 MILS)
TC	10 FT. WHITE SKIP	THERMOPLASTIC (4", 120 MILS)
TD	3 FT. - 9 FT. WHITE MINISKIP	THERMOPLASTIC (4", 120 MILS)
TE	WHITE SOLID LANE LINE	THERMOPLASTIC (4", 120 MILS)
TN	WHITE GORE LINE	THERMOPLASTIC (8", 90 MILS)
TU	WHITE DIAGONAL	THERMOPLASTIC (12", 90 MILS)
T2	WHITE STOP BAR	THERMOPLASTIC (24", 120 MILS)
UA	LEFT TURN ARROW	THERMOPLASTIC (90 MILS)
UB	RIGHT TURN ARROW	THERMOPLASTIC (90 MILS)
UC	STRAIGHT ARROW	THERMOPLASTIC (90 MILS)
MB	CRYSTAL & RED	PERMANENT RAISED PAVEMENT MARKERS

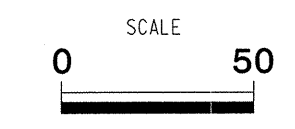

**ATKINS** 1616 EAST MILLBROOK ROAD, SUITE 310  
 RALEIGH, NORTH CAROLINA 27609  
 (919) 876-6888 NCBEES #F-0326

**PAVEMENT MARKING PLANS**  
 -L- GEORGE LILES PKWY

20-FEB-2013 18:51  
 G:\Transportation\Traffic\Cur\00030391R-2246B GL Pkwy SPM\PM\Revision Feb2013\PM\_13.dgn  
 15637 AT RALCNU2252BLM

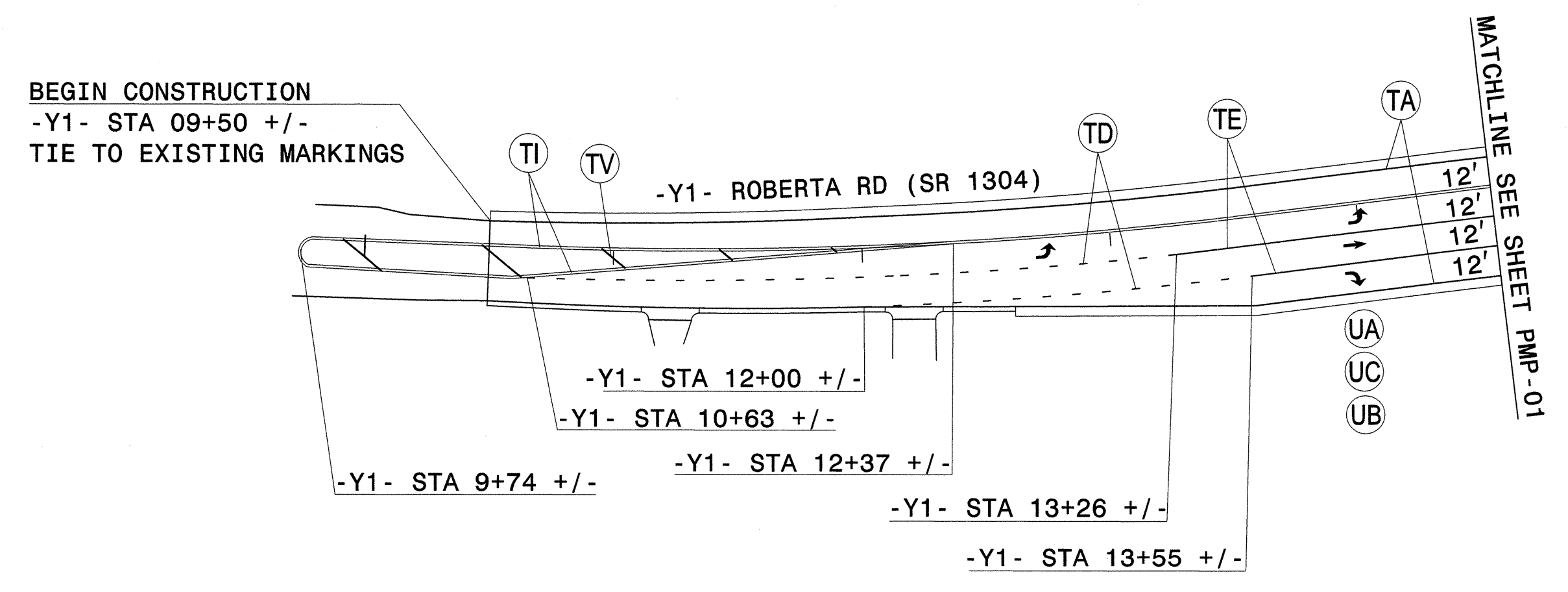

**PAVEMENT MARKING SCHEDULE**

SYMBOL	DESCRIPTION	
TA	WHITE EDGELINE	THERMOPLASTIC (4", 90 MILS)
TD	3 FT. - 9 FT. WHITE MINISKIP	THERMOPLASTIC (4", 120 MILS)
TE	WHITE SOLID LANE LINE	THERMOPLASTIC (4", 120 MILS)
TI	DOUBLE YELLOW CENTERLINE	THERMOPLASTIC (4", 120 MILS)
TV	YELLOW DIAGONAL	THERMOPLASTIC (12", 90 MILS)
UA	LEFT TURN ARROW	THERMOPLASTIC (90 MILS)
UB	RIGHT TURN ARROW	THERMOPLASTIC (90 MILS)
UC	STRAIGHT ARROW	THERMOPLASTIC (90 MILS)

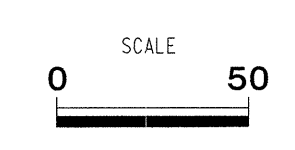
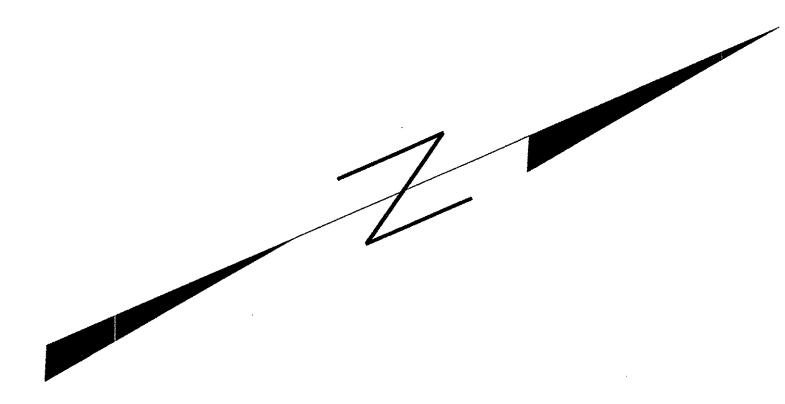

**ATKINS** 1616 EAST MILLBROOK ROAD, SUITE 310  
 RALEIGH, NORTH CAROLINA 27609  
 (919) 876-6888 NCBEES #F-0326

**PAVEMENT MARKING PLANS**  
 -Y1- ROBERTA RD (SR 1304)

20-FEB-2013 19:26  
 G:\Transportation\Traffic\00030391R-2246B GL Pkwy SPM\PM\Revision Feb2013\PM\_14.dgn  
 15637 AT RALCNU2252BLM

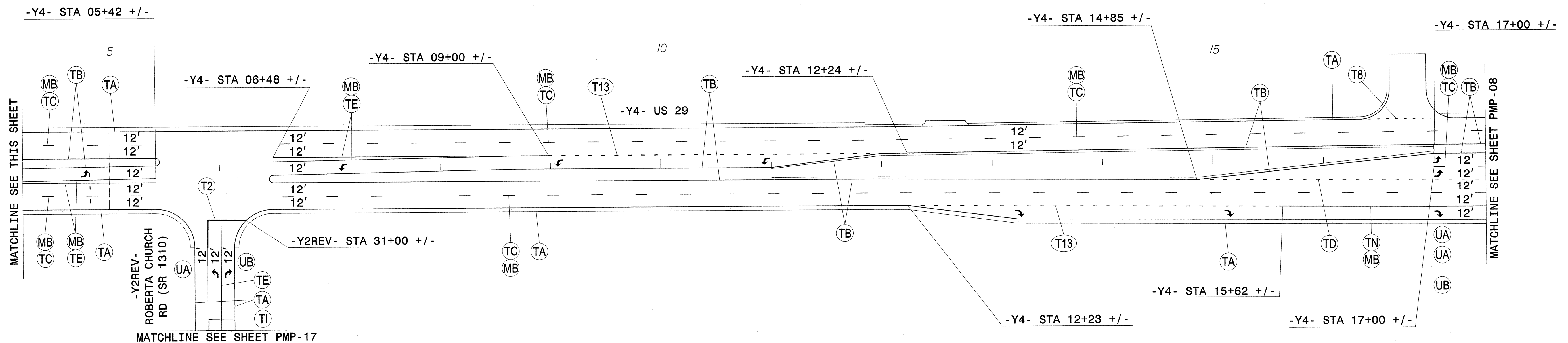
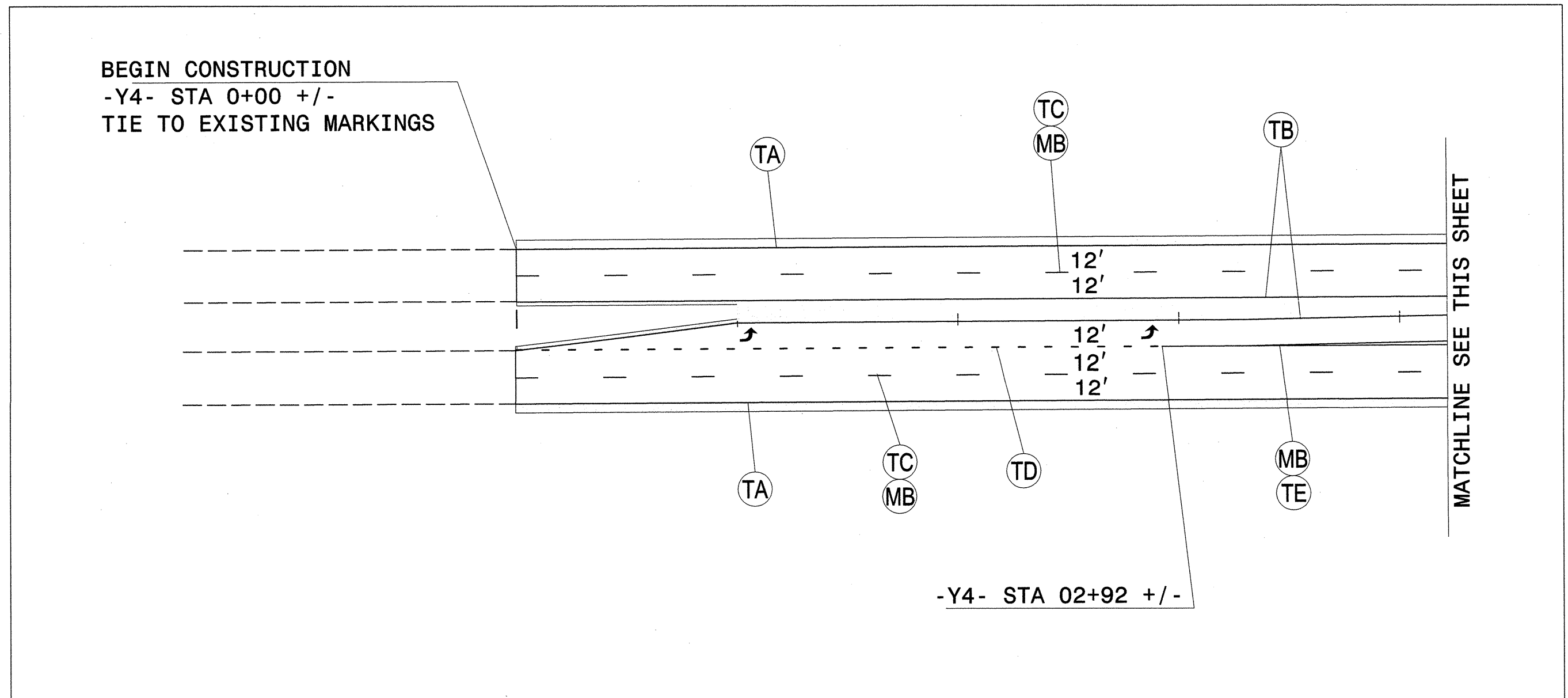

**PAVEMENT MARKING SCHEDULE**

SYMBOL	DESCRIPTION	
TA	WHITE EDGELINE	THERMOPLASTIC (4", 90 MILS)
TB	YELLOW EDGE LINE	THERMOPLASTIC (4", 90 MILS)
TC	10 FT. WHITE SKIP	THERMOPLASTIC (4", 120 MILS)
TD	3 FT. - 9 FT. WHITE MINISKIP	THERMOPLASTIC (4", 120 MILS)
TE	WHITE SOLID LANE LINE	THERMOPLASTIC (4", 120 MILS)
TI	DOUBLE YELLOW CENTERLINE	THERMOPLASTIC (4", 120 MILS)
TN	WHITE GORE LINE	THERMOPLASTIC (8", 90 MILS)
T2	WHITE STOP BAR	THERMOPLASTIC (24", 120 MILS)
T8	2 FT. - 6 FT. WHITE MINISKIP	THERMOPLASTIC (4", 120 MILS)
T13	3 FT. - 9 FT. WHITE MINISKIP	THERMOPLASTIC (8", 120 MILS)
UA	LEFT TURN ARROW	THERMOPLASTIC (90 MILS)
UB	RIGHT TURN ARROW	THERMOPLASTIC (90 MILS)
MB	CRYSTAL & RED	PERMANENT RAISED PAVEMENT MARKERS

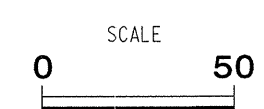

**ATKINS**

1616 EAST MILLBROOK ROAD, SUITE 310  
 RALEIGH, NORTH CAROLINA 27609  
 (919) 876-6888 NCBEES #F-0326

**PAVEMENT MARKING PLANS**  
 -Y4- US 29

20-FEB-2013 19:25  
 O:\Transportation\Traffic\100030391R-2246B GL Pkwy SPM\PM\Revision Feb2013\PM\_15.dgn  
 15637 AT RALCNU252BLM



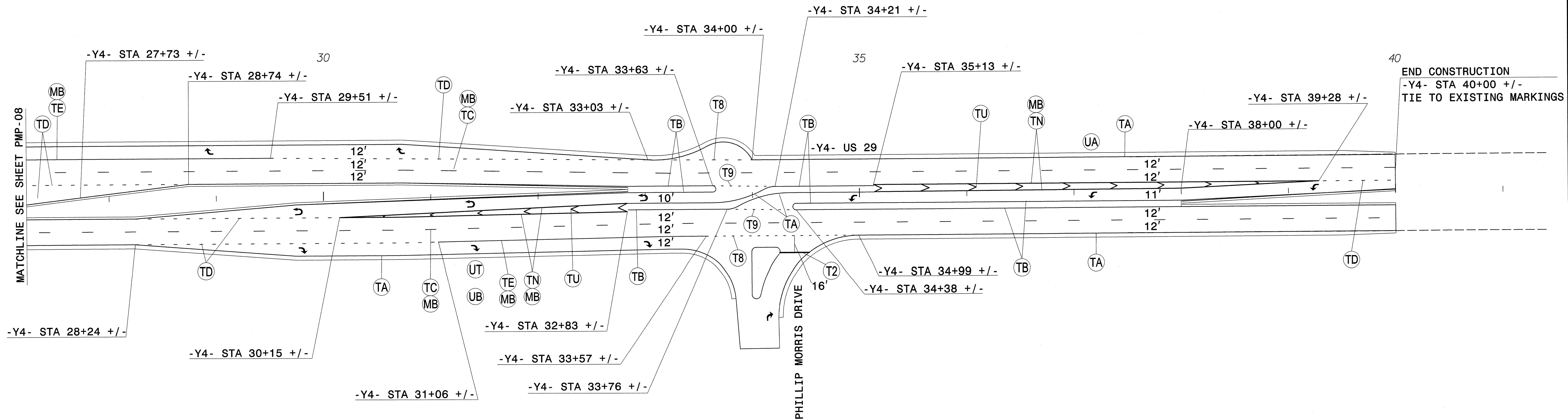

**PAVEMENT MARKING SCHEDULE**

SYMBOL	DESCRIPTION	
TA	WHITE EDGELINE	THERMOPLASTIC (4", 90 MILS)
TB	YELLOW EDGE LINE	THERMOPLASTIC (4", 90 MILS)
TC	10 FT. WHITE SKIP	THERMOPLASTIC (4", 120 MILS)
TD	3 FT. - 9 FT. WHITE MINISKIP	THERMOPLASTIC (4", 120 MILS)
TE	WHITE SOLID LANE LINE	THERMOPLASTIC (4", 120 MILS)
TN	WHITE GORE LINE	THERMOPLASTIC (8", 90 MILS)
TU	WHITE DIAGONAL	THERMOPLASTIC (12", 90 MILS)
T2	WHITE STOP BAR	THERMOPLASTIC (24", 120 MILS)
T8	2 FT. - 6 FT. WHITE MINISKIP	THERMOPLASTIC (4", 120 MILS)
T9	2 FT. - 6 FT. YELLOW MINISKIP	THERMOPLASTIC (4", 120 MILS)
UA	LEFT TURN ARROW	THERMOPLASTIC (90 MILS)
UB	RIGHT TURN ARROW	THERMOPLASTIC (90 MILS)
UT	U-TURN ARROW	THERMOPLASTIC (90 MILS)
MB	CRYSTAL & RED	PERMANENT RAISED PAVEMENT MARKERS

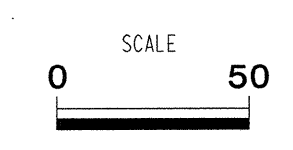

**ATKINS** 1616 EAST MILLBROOK ROAD, SUITE 310  
RALEIGH, NORTH CAROLINA 27609  
(919) 876-6888 NCBEES #F-0326

**PAVEMENT MARKING PLANS**  
-Y4- US 29

20-FEB-2013 18:51  
O:\TR\onspord\Tation\Tr\off\c\curr\00030391R-2246B\_GL\_Pkwy\_SPM\PM\Revision Feb2013\PM\_16.dgn  
15637 AT RALCN2252BLM

TIP NO. R-2246B	SHEET NO. PMP-17
APPROVED: <i>Melissa B. Toth</i>	
DATE: 2/20/13	
SEAL	
	

MATCHLINE SEE SHEET PMP-15

TE  
-Y2REV- STA 29+95 +/-  
TD  
-Y2REV- STA 29+17 +/-

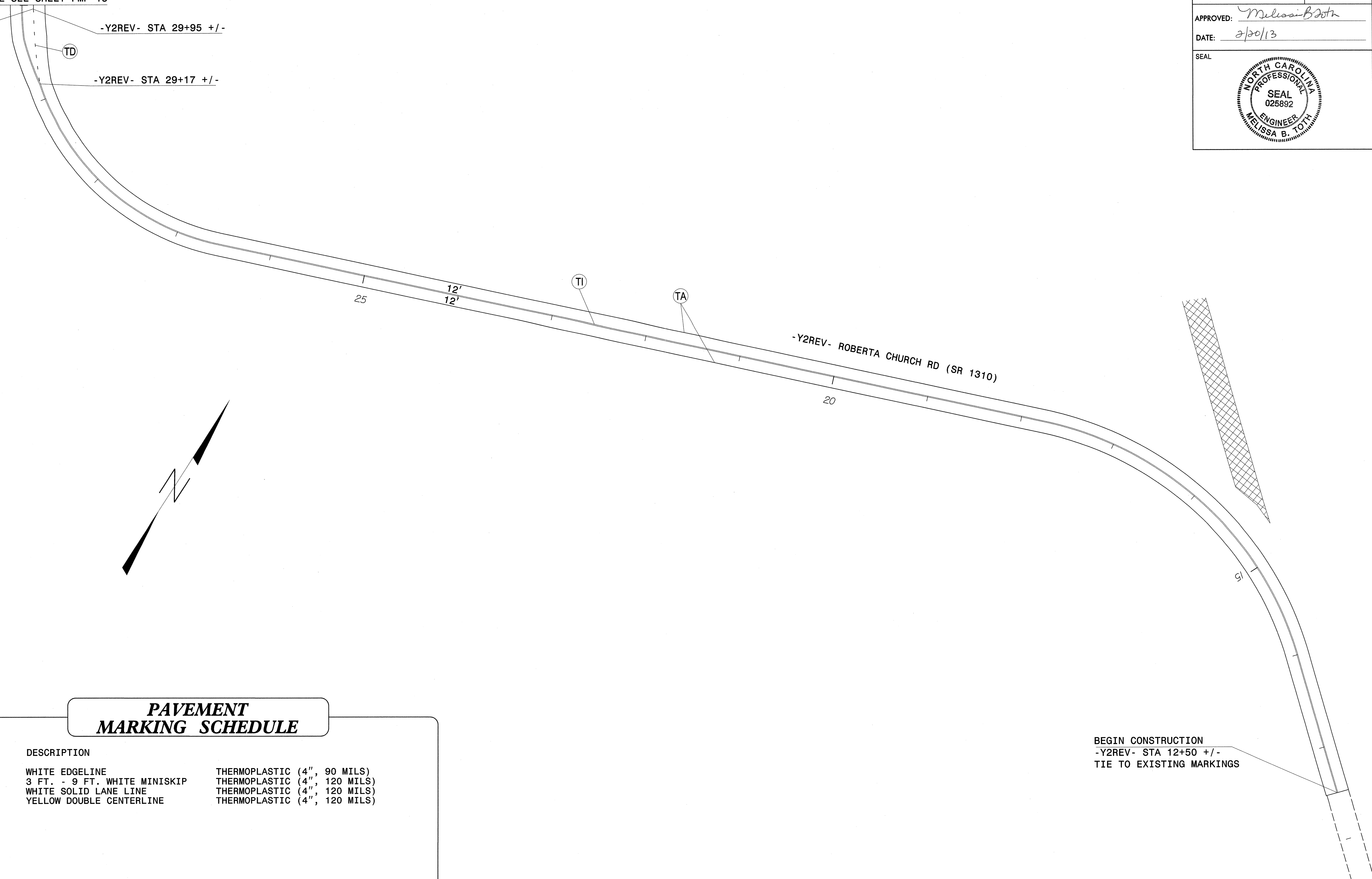

-Y2REV- ROBERTA CHURCH RD (SR 1310)

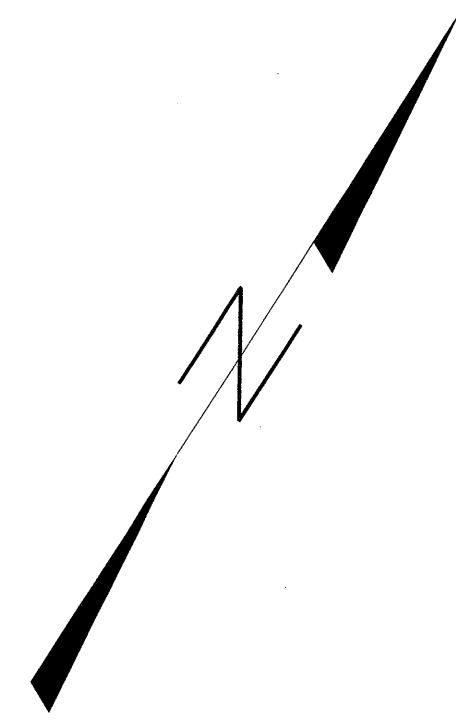

**PAVEMENT MARKING SCHEDULE**

SYMBOL	DESCRIPTION	
TA	WHITE EDGELINE	THERMOPLASTIC (4", 90 MILS)
TD	3 FT. - 9 FT. WHITE MINISKIP	THERMOPLASTIC (4", 120 MILS)
TE	WHITE SOLID LANE LINE	THERMOPLASTIC (4", 120 MILS)
TI	YELLOW DOUBLE CENTERLINE	THERMOPLASTIC (4", 120 MILS)

BEGIN CONSTRUCTION  
-Y2REV- STA 12+50 +/-  
TIE TO EXISTING MARKINGS



**ATKINS** 1616 EAST MILLBROOK ROAD, SUITE 310  
RALEIGH, NORTH CAROLINA 27609  
(919) 876-6888 NCBES #F-0326

**PAVEMENT MARKING PLANS**  
-Y2REV- ROBERTA CHURCH ROAD

20-FEB-2013 18:51  
0:\T\transportation\Traffic\00030391R-2246B\_GL\_Pkwy\_SPM\PM\Revision Feb2013\PM\_17.dgn  
15637 AT RALCN2252BLM

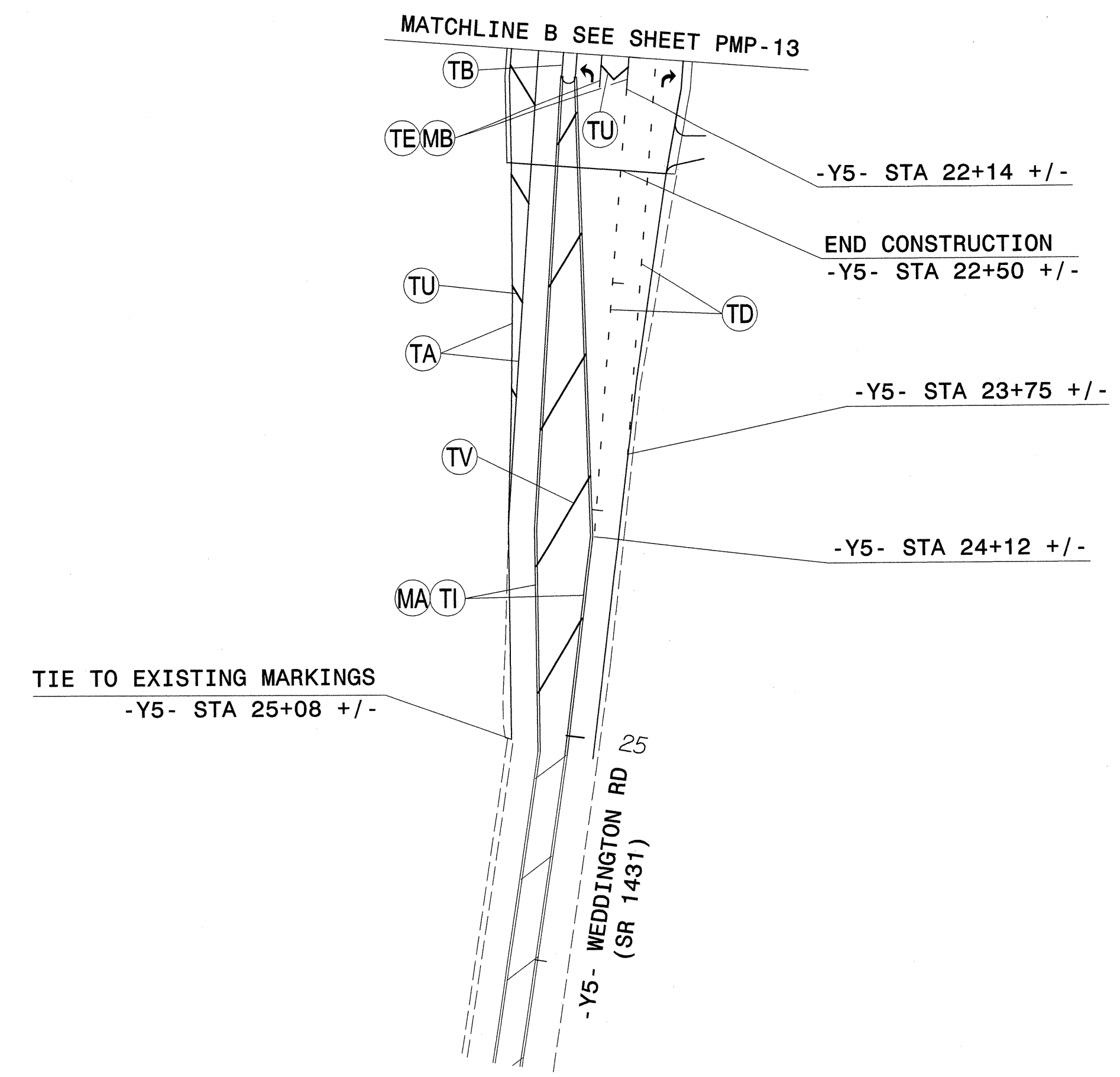
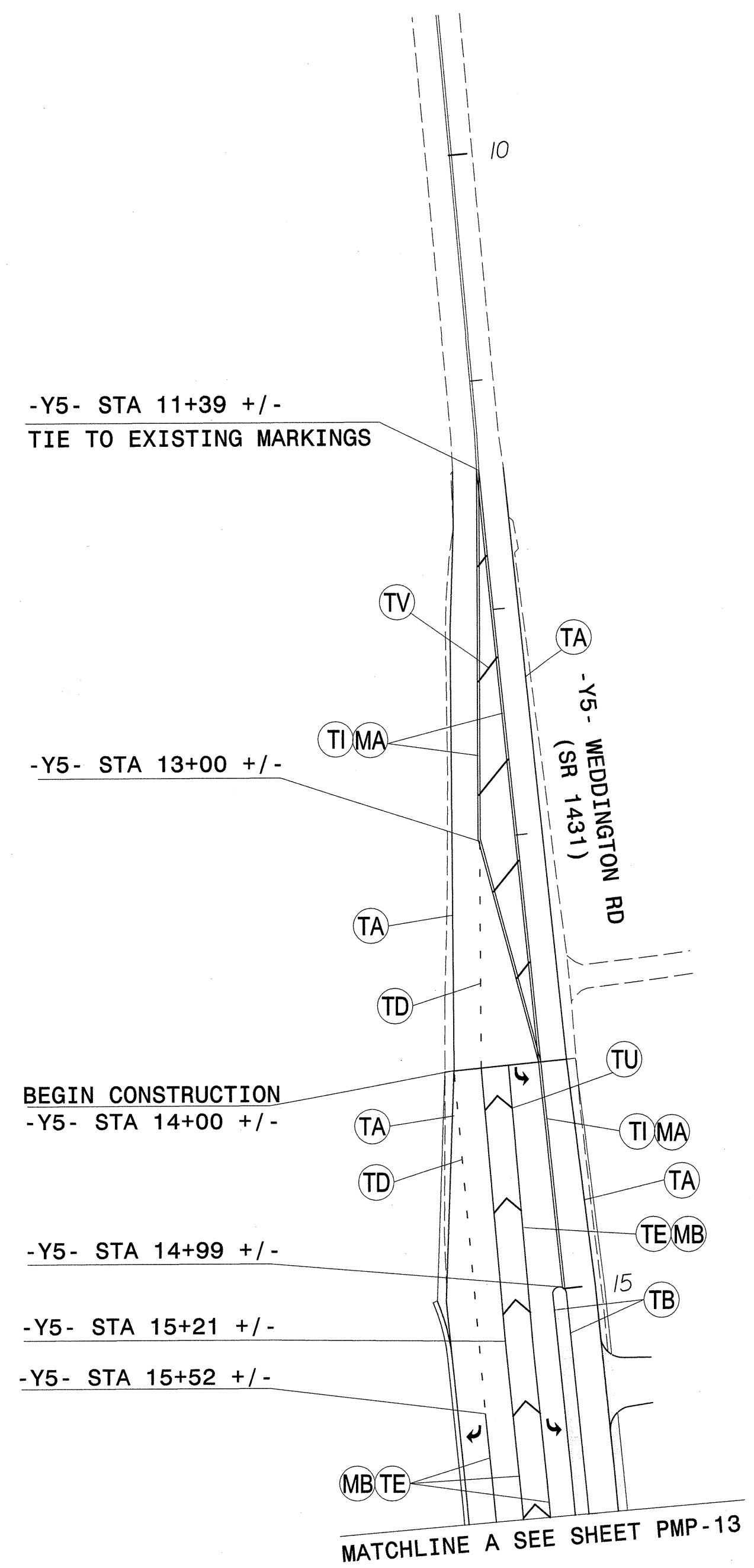

**PAVEMENT MARKING SCHEDULE**

SYMBOL	DESCRIPTION	
TA	WHITE EDGELINE	THERMOPLASTIC (4", 90 MILS)
TB	YELLOW EDGELINE	THERMOPLASTIC (4", 90 MILS)
TD	3 FT. - 9 FT. WHITE MINISKIP	THERMOPLASTIC (4", 120 MILS)
TE	WHITE SOLID LANE LINE	THERMOPLASTIC (4", 120 MILS)
TI	YELLOW DOUBLE CENTERLINE	THERMOPLASTIC (4", 120 MILS)
TU	WHITE DIAGONAL	THERMOPLASTIC (12", 90 MILS)
TV	YELLOW DIAGONAL	THERMOPLASTIC (12", 90 MILS)
UA	LEFT TURN ARROW	THERMOPLASTIC (90 MILS)
UB	RIGHT TURN ARROW	THERMOPLASTIC (90 MILS)
MA	YELLOW & YELLOW	PERMANENT RAISED PAVEMENT MARKERS
MB	CRYSTAL & RED	PERMANENT RAISED PAVEMENT MARKERS

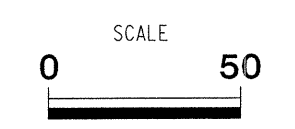
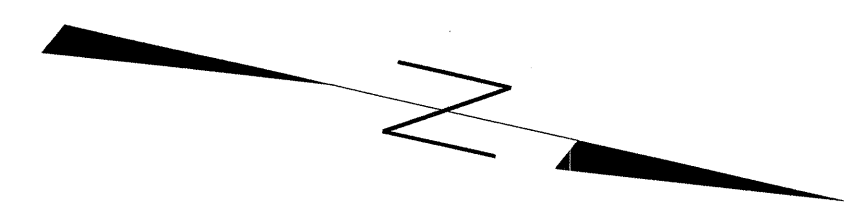

**ATKINS** 1616 EAST MILLBROOK ROAD, SUITE 310  
 RALEIGH, NORTH CAROLINA 27609  
 (919) 876-6888 NCBES #F-0326

**PAVEMENT MARKING PLANS**  
 -Y5- WEDDINGTON RD (SR 1431)

20-FEB-2013 19:23  
 G:\Transportation\Tiff\030391R-2246B GL Pkwy SPM\PM\Revision Feb2013\PM\_18.dgn  
 AT RALCNU2252BLM 15637