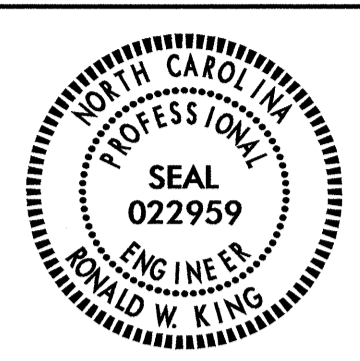

**STATE OF NORTH CAROLINA  
DEPARTMENT OF TRANSPORTATION**

TIP NO. R-3405	SHEET NO. SIGN-1
APPROVED: <i>[Signature]</i>	
DATE: 6/5/12	
SEAL	
	

**SIGNING PLAN  
WILKES COUNTY**

**LOCATION: NC 18 FROM SR 1002 (MT. VIEW RD) TO  
SR 1717 (YELLOW BANKS RD)**

**T.I.P.: R-3405**

**ROADWAY STANDARD DRAWING**

THE FOLLOWING ROADWAY STANDARDS AS APPEAR IN "ROADWAY STANDARD DRAWINGS" - PROJECT SERVICES UNIT - N.C. DEPARTMENT OF TRANSPORTATION - RALEIGH, N.C., DATED JANUARY 2012 ARE APPLICABLE TO THIS PROJECT AND BY REFERENCE HEREBY ARE CONSIDERED A PART OF THESE PLANS:

STD. NO.	TITLE
904.10	ORIENTATION OF GROUND MOUNTED SIGNS
904.50	MOUNTING OF TYPE 'D', 'E' AND 'F' SIGNS ON 'U' CHANNEL POSTS

**GENERAL NOTES**

- . SIGNS FURNISHED BY STATE
- . ALL TYPE 'D' SIGNS SHALL BE MOUNTED ON TWO U-CHANNEL POSTS UNLESS OTHERWISE INDICATED ON THE PLANS.
- . IF REMOVAL OR RELOCATION OF SIGNS ON PRIVATE STREET (NON-STATE MAINTAINED) IS REQUIRED DUE TO CONSTRUCTION, THE CONTRACTOR SHALL INFORM THE ENGINEER. THE WORK WILL BE COMPLETED BY OTHERS.
- . WHEN NOT STATIONED OR DIMENSIONED ON PLANS, ALL 'E' AND 'F' SIGNS SHALL BE FIELD LOCATED BY THE ENGINEER
- . ALL EXISTING SIGNS ON "U" CHANNEL POST WITHIN THE PROJECT LIMITS SHALL BE REMOVED AND DISPOSED OF UNLESS OTHERWISE NOTED ON PLANS.
- . WHEN EXISTING SIGNS ARE REMOVED AND INSTALLED ON NEW SUPPORTS, THE RE-ERECTION SHALL IMMEDIATELY FOLLOW THE REMOVAL.
- . THE BACKGROUND FOR TYPE E & F SIGNS SHALL BE TYPE C REFLECTIVE SHEETING.
- . SEE ROADWAY PLANS FOR GUARD/GUIDE RAIL DETAILS.

**SUMMARY OF QUANTITIES**

ITEM NO.		ITEM DESCRIPTION	QUANTITY	UNIT
DESC. NO.	SECT. NO.			
4072000000	903	SUPPORTS, 3 LB STEEL U-CHANNEL	1664	L.F.
4102000000	904	SIGN ERECTION, TYPE E	72	EA.
4108000000	904	SIGN ERECTION, TYPE F	2	EA.
4116100000	904	SIGN ERECTION, RELOCATE SIGN TYPE E	1	EA.
4155000000	907	DISPOSAL OF SIGN SYSTEM, U-CHANNEL	83	EA.

**PROJECT NOTES**

- 1 DISPOSAL OF SIGN SYSTEM, U-CHANNEL
- 2 RELOCATE SIGN, TYPE E

**INDEX**

SHEET NO.	DESCRIPTION
SIGN-1	TITLE SHEET
SIGN-2	E AND F SHEETS
SIGN-3-16	SIGNING PLAN SHEETS

PLAN PREPARED BY: N.C.D.O.T. SIGNING AND DELINEATION UNIT

Kelvin Jordan SIGNING & DELINEATION REGIONAL ENGINEER  
J.Navarrete SIGNING & DELINEATION PROJECT DESIGN ENGINEER

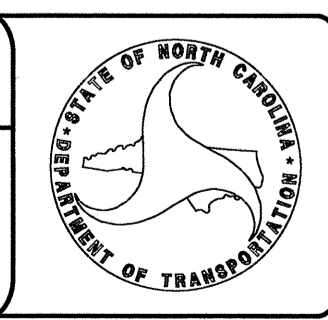

05-JUN-2012 11:42 J:\navarrete\05\06\05\T:\p\fric\Signing\CADD\Signing Layout Plans\R-3405\_Sgn\_sheets.dgn

**CONTRACT:**

402 QUANTITY REQ'D 3



30" X 30"  
W14-2

ONE "U" POST PER SIGN

407 QUANTITY REQ'D 2



30" X 30"  
W1-2L

ONE "U" POST PER SIGN

412 QUANTITY REQ'D 4



24" X 8"  
S4-3

MOUNT BELOW SIGN 411. MOUNT ABOVE SIGN 414.  
IN 2. INSTALLATIONS IN 2. INSTALLATIONS

ONE "U" POST PER SIGN

501



24" X 12"

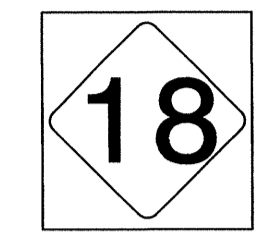

24" X 24"

403 QUANTITY REQ'D 5

MOUNT BELOW SIGN 402  
IN 3. INSTALLATIONS

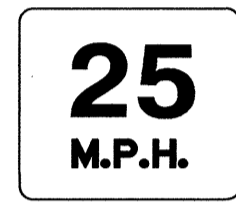

18" X 18"  
W13-1P

MOUNT BELOW SIGN 405 MOUNT BELOW SIGN 418  
IN 1. INSTALLATIONS IN 1. INSTALLATIONS

ONE "U" POST PER SIGN

408 QUANTITY REQ'D 2



30" X 30"  
W1-2R

ONE "U" POST PER SIGN

413 QUANTITY REQ'D 2

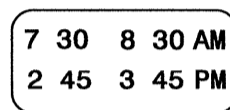

24" X 10"  
S4-1

MOUNT BELOW SIGN 414.  
IN 2. INSTALLATIONS

ONE "U" POST PER SIGN

502



24" X 12"

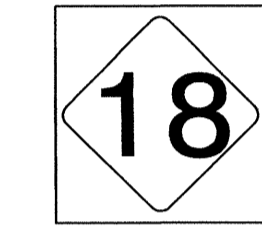

24" X 24"

404 QUANTITY REQ'D 1

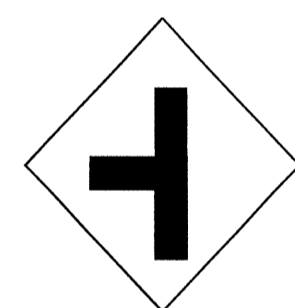

30 X 30  
W2-2

ONE "U" POST PER SIGN

409 QUANTITY REQ'D 20

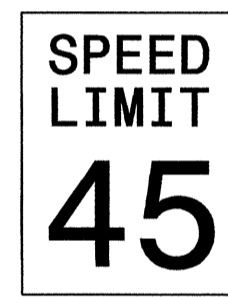

24" X 30"  
R2-1

TWO "U" POSTS PER SIGN

414 QUANTITY REQ'D 2

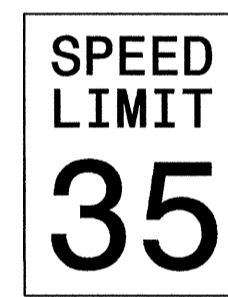

24" X 30"  
R2-1

TWO "U" POSTS PER SIGN

405 QUANTITY REQ'D 1

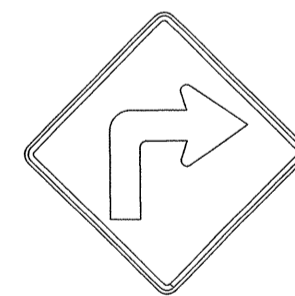

30" X 30"  
W1-1R

ONE "U" POST PER SIGN

410 QUANTITY REQ'D 21

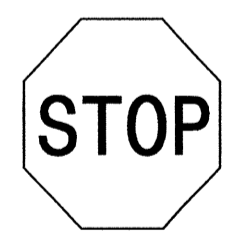

30" X 30"  
R1-1

ONE "U" POST PER SIGN

416 QUANTITY REQ'D 2

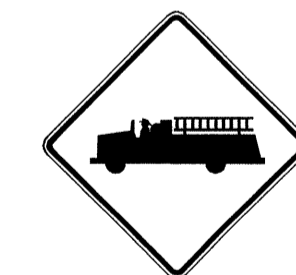

30" X 30"  
W11-8

ONE "U" POST PER SIGN

406 QUANTITY REQ'D 2

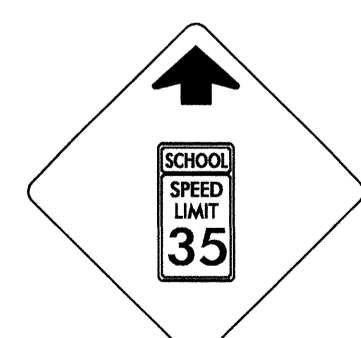

36" X 36"  
S4-5

YELLOW/GREEN REFLECTIVE SHEETING

TWO "U" POSTS PER SIGN

411 QUANTITY REQ'D 2



36" X 36"  
S1-1

YELLOW/GREEN REFLECTIVE SHEETING

ONE "U" POSTS PER SIGN

418 QUANTITY REQ'D 1

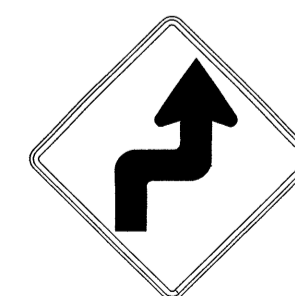

30" X 30"  
W1-3

ONE "U" POST PER SIGN

TYPE "E" & "F" SIGNS

TIP NO. R-3405	SHEET NO. SIGN-3
APPROVED: <i>[Signature]</i>	
DATE: 6/5/12	
SEAL	
	

BEGIN PROJECT R3405  
-L- STA. 10+00 +/-

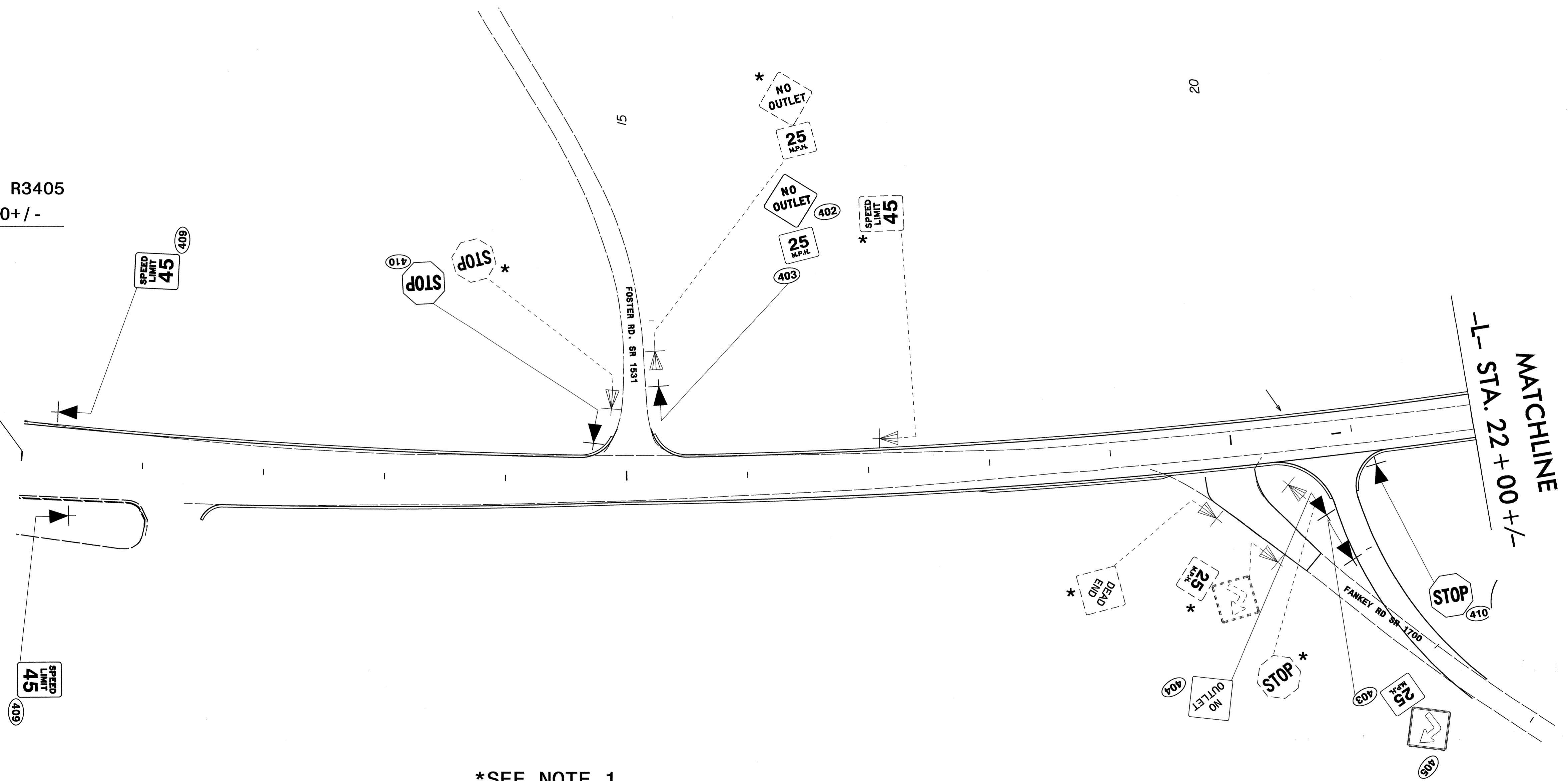

\*SEE NOTE 1

SIGNING PLAN SHEET

04 JUN 2012 16:12:03  
 C:\Users\jking\Documents\Projects\R3405\Traffic\Signing\CADD\Signing Layout Plans\R-3405\_Sgn\_sheets.dgn  
 jking AT 12246703

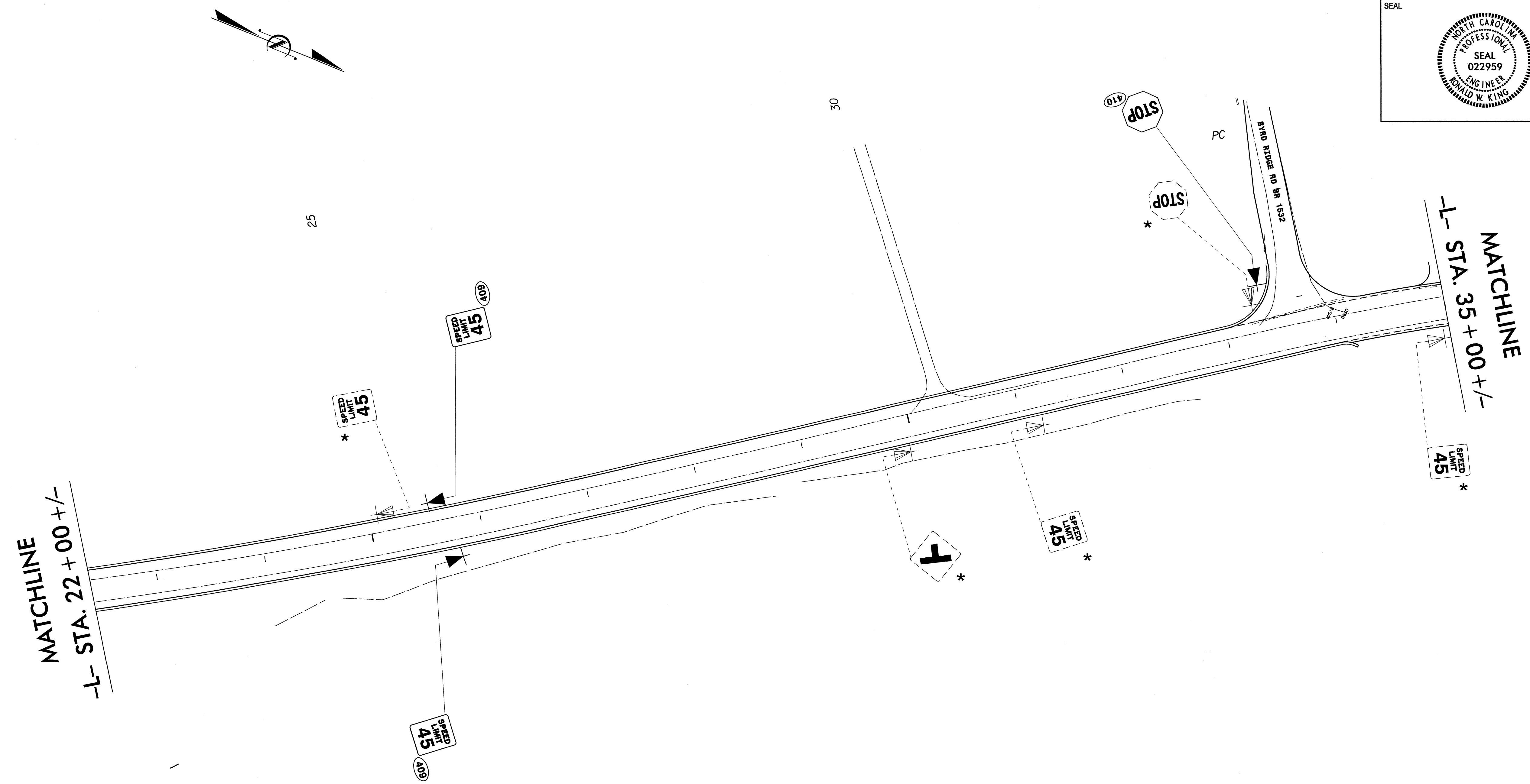

TIP NO. R-3405	SHEET NO. SIGN-4
APPROVED: <i>RHW</i>	
DATE: 6/5/12	
SEAL	
	



\*SEE NOTE 1

SIGNING PLAN SHEET

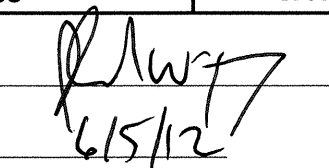
04 July 2012 16:52:03 R3405-Traffic\Signing\CADD\Signing Layout Plans\R-3405\_Sgn\_sheets.dgn  
 Unsaved AT 12236703

TIP NO. R-3405	SHEET NO. SIGN-5
APPROVED: 	
DATE: 6/15/12	
SEAL	
	

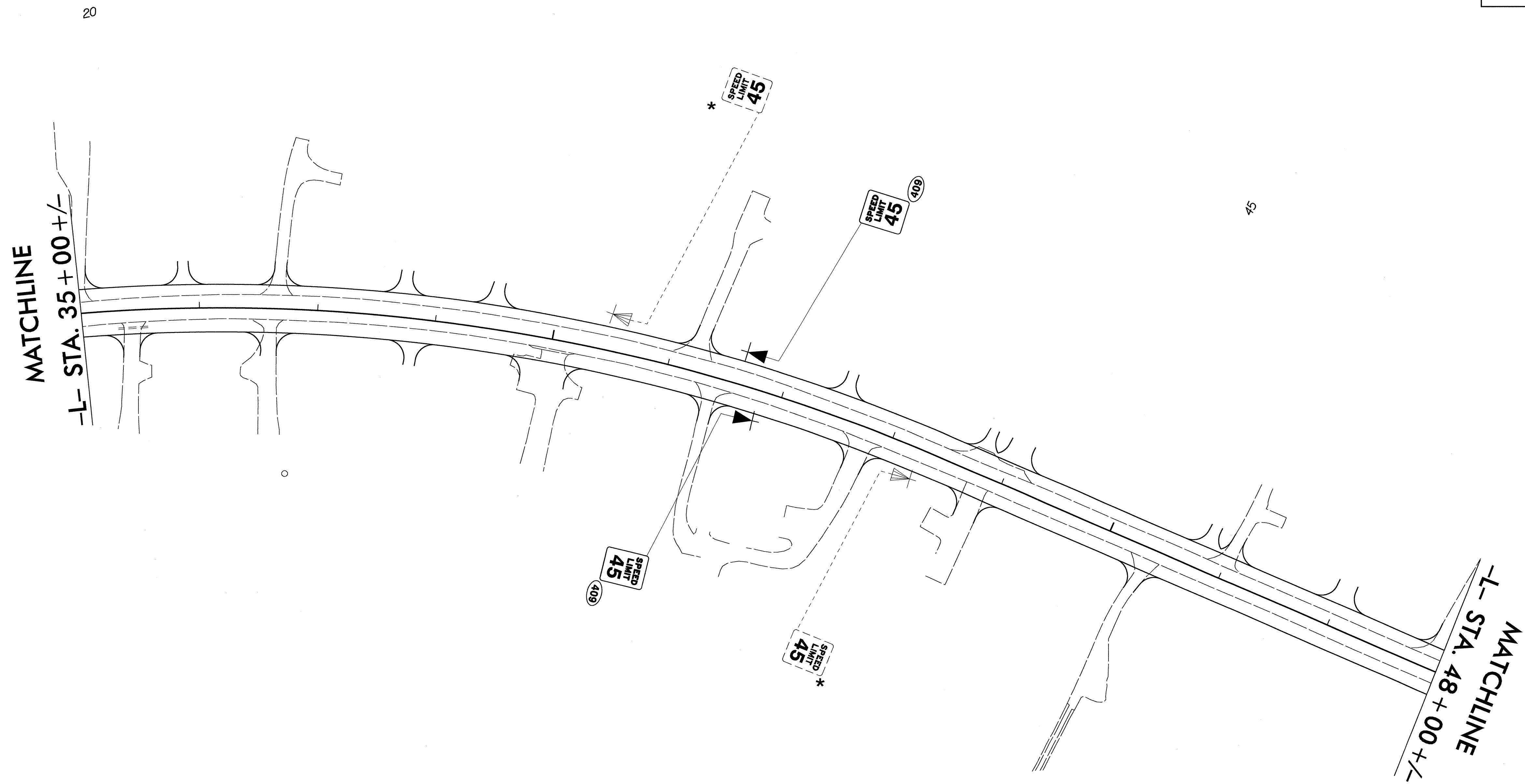

\*SEE NOTE 1

SIGNING PLAN SHEET

04 JUN 2012 16:53  
 P:\3405\Traffic\Signing\CADD\Signing Layout Plans\R-3405\_Sgn.sheets.dgn  
 Unsaved AT 12246703

TIP NO. R-3405	SHEET NO. SIGN-6
APPROVED: <i>RWT</i>	
DATE: 6/5/12	
SEAL	
	

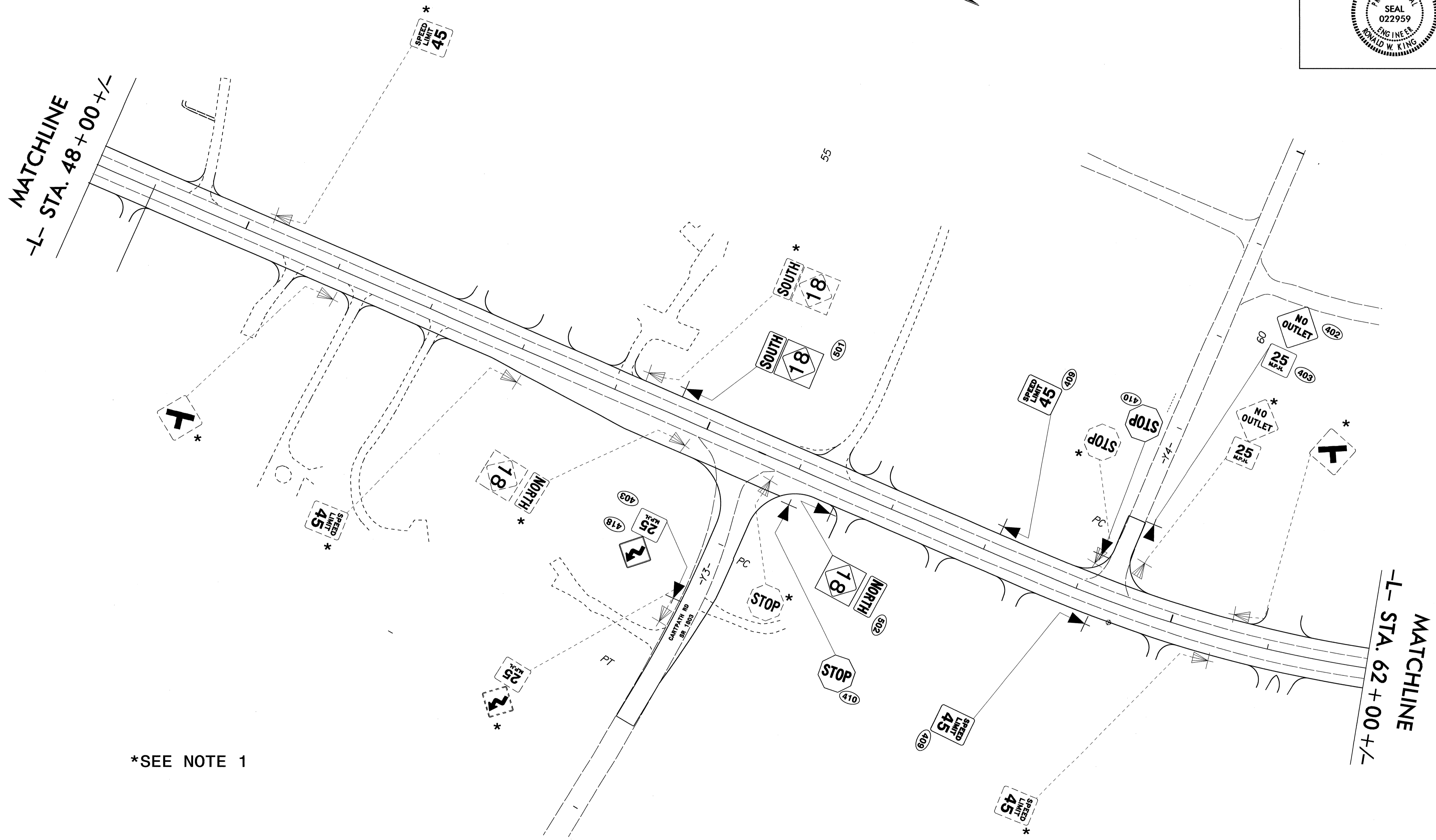

**SIGNING PLAN SHEET**

04 JUN 2012 16:53  
 R:\Projects\2012\6235\2012\6235\Traffic\Signing\CADD\Signing Layout Plans\R-3405\_Sgn\_sheets.dgn  
 Unverified 11/22/12 10:33

TIP NO. R-3405	SHEET NO. SIGN-7
APPROVED: <i>[Signature]</i>	
DATE: 6/5/12	
SEAL	



**SIGNING PLAN SHEET**

04-JUL-2012 16:44  
 C:\Users\jking\Documents\Projects\R-3405\Signing\Layout\Plans\R-3405\_Sgn\_sheets.dgn  
 Unsaved AT 12:46:03

TIP NO. R-3405	SHEET NO. SIGN-8
APPROVED: <i>[Signature]</i>	
DATE: <i>12/5/12</i>	
SEAL	

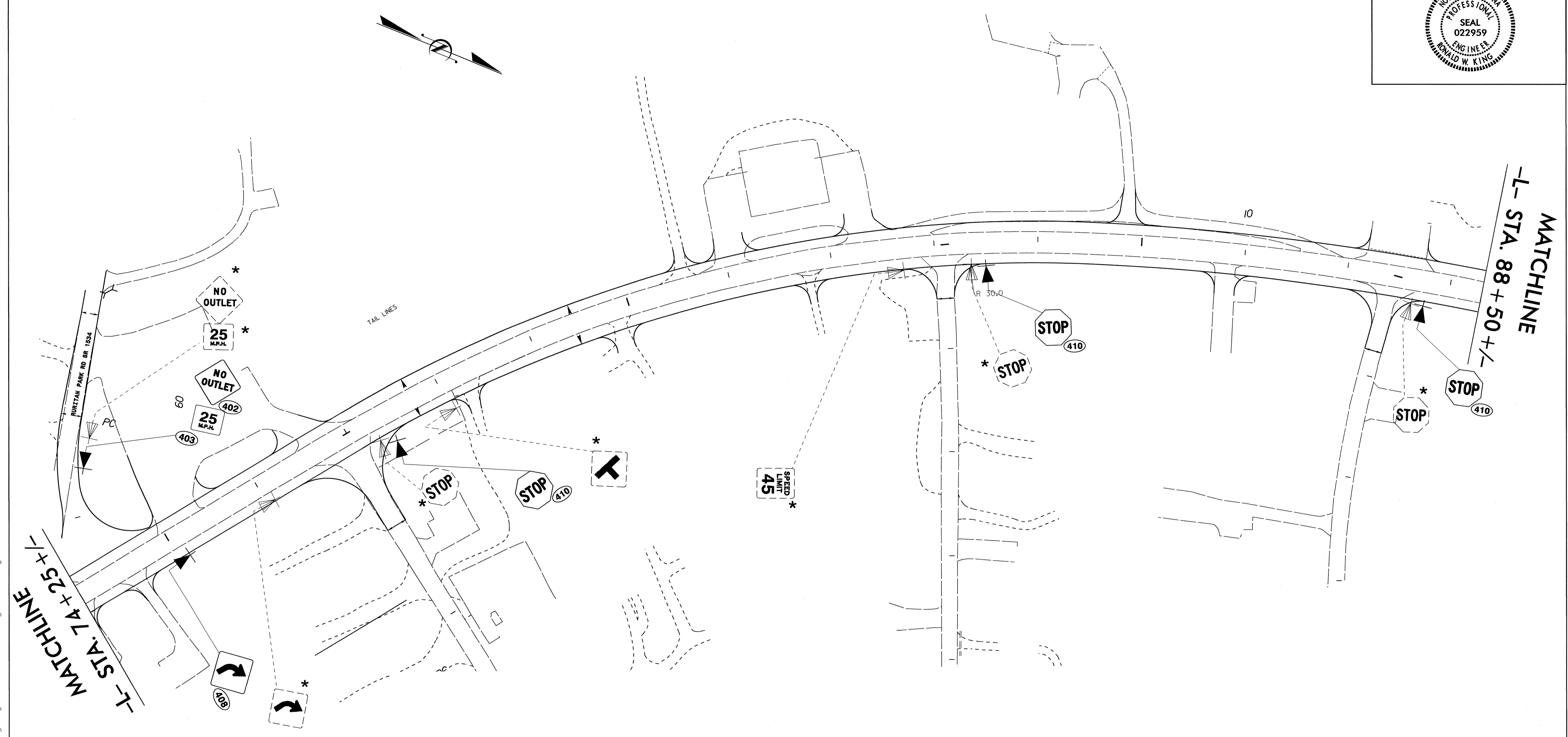

\*SEE NOTE 1

**SIGNING PLAN SHEET**

04-1111-2012 16:14  
 C:\Users\jking\Documents\Projects\12246703\12246703\Signing\CADD\Signing Layout Plans\R-3405\_Sgn\_sheets.dgn  
 jking



TIP NO. R-3405	SHEET NO. SIGN-9
APPROVED: <i>[Signature]</i>	
DATE: 4/5/12	
SEAL	
	

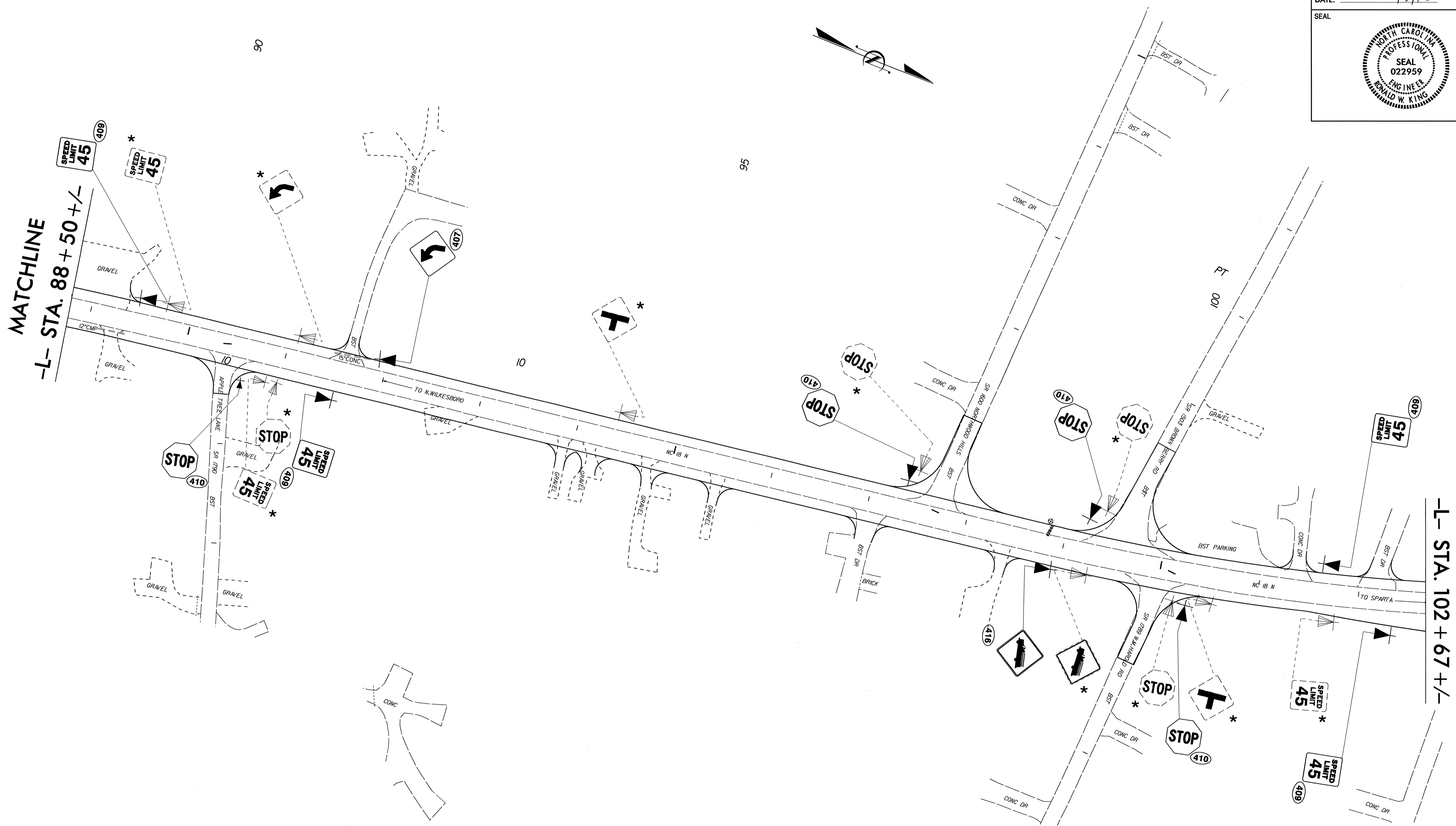

\*SEE NOTE 1

SIGNING PLAN SHEET

04\_H:\11-2012\16314...R3405\Trafic\Signing\Layout\Plans\R-3405\_Sgn\_sheets.dgn  
 Unverified At 11:24:03

TIP NO. R-3405	SHEET NO. SIGN-10
APPROVED: <i>[Signature]</i>	
DATE: 6/5/12	
SEAL	

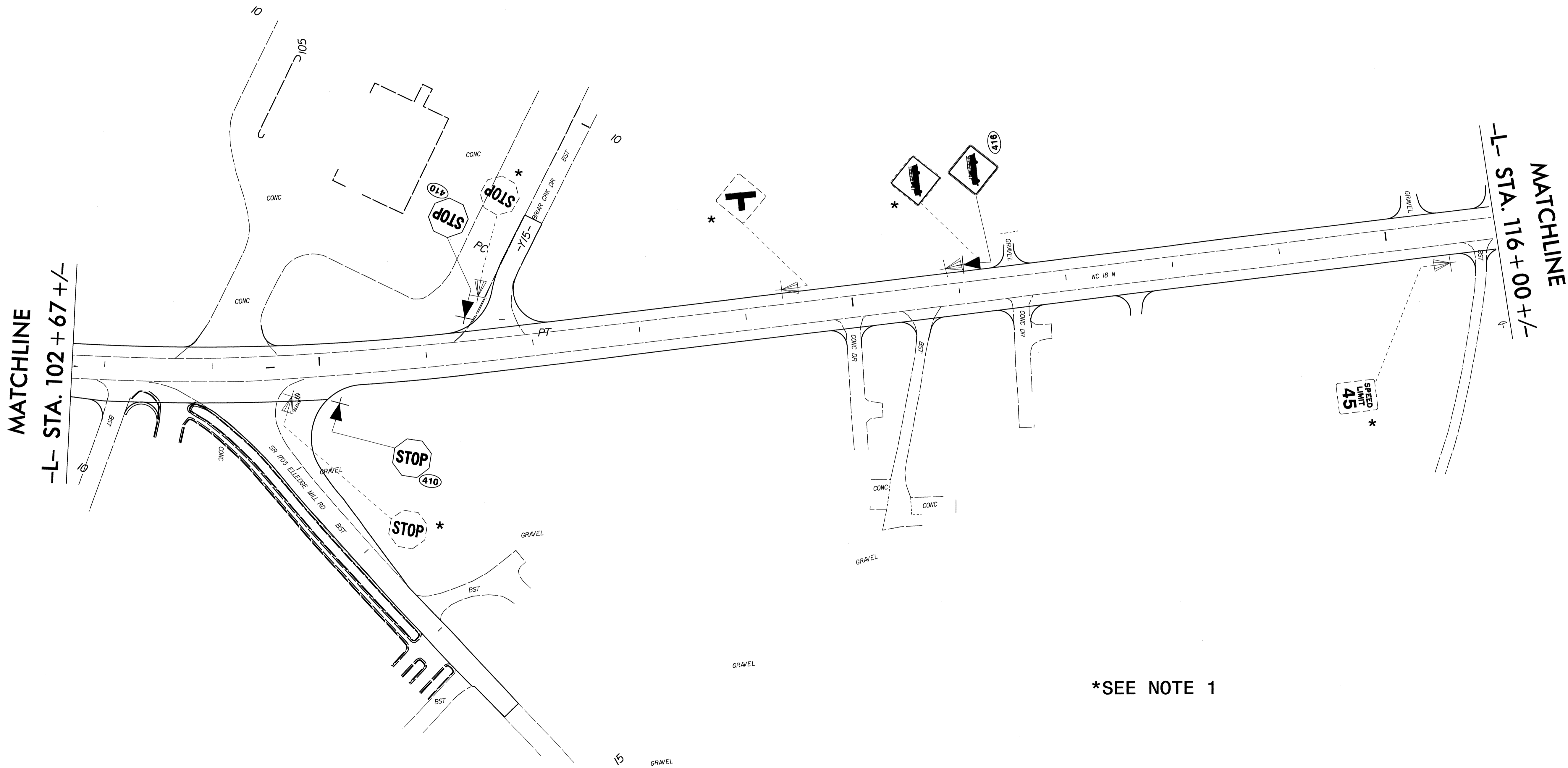
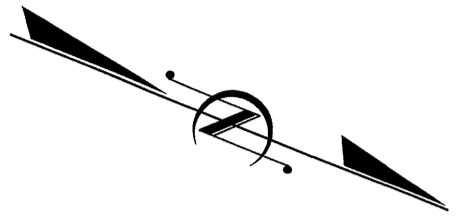

\*SEE NOTE 1

**SIGNING PLAN SHEET**

04 JUN 2012 06:55  
 P:\3405\Trafic\Signing\CADD\Signing Layout Plans\R-3405\_Sgn\_sheets.dgn  
 Unsaved 41 12246703

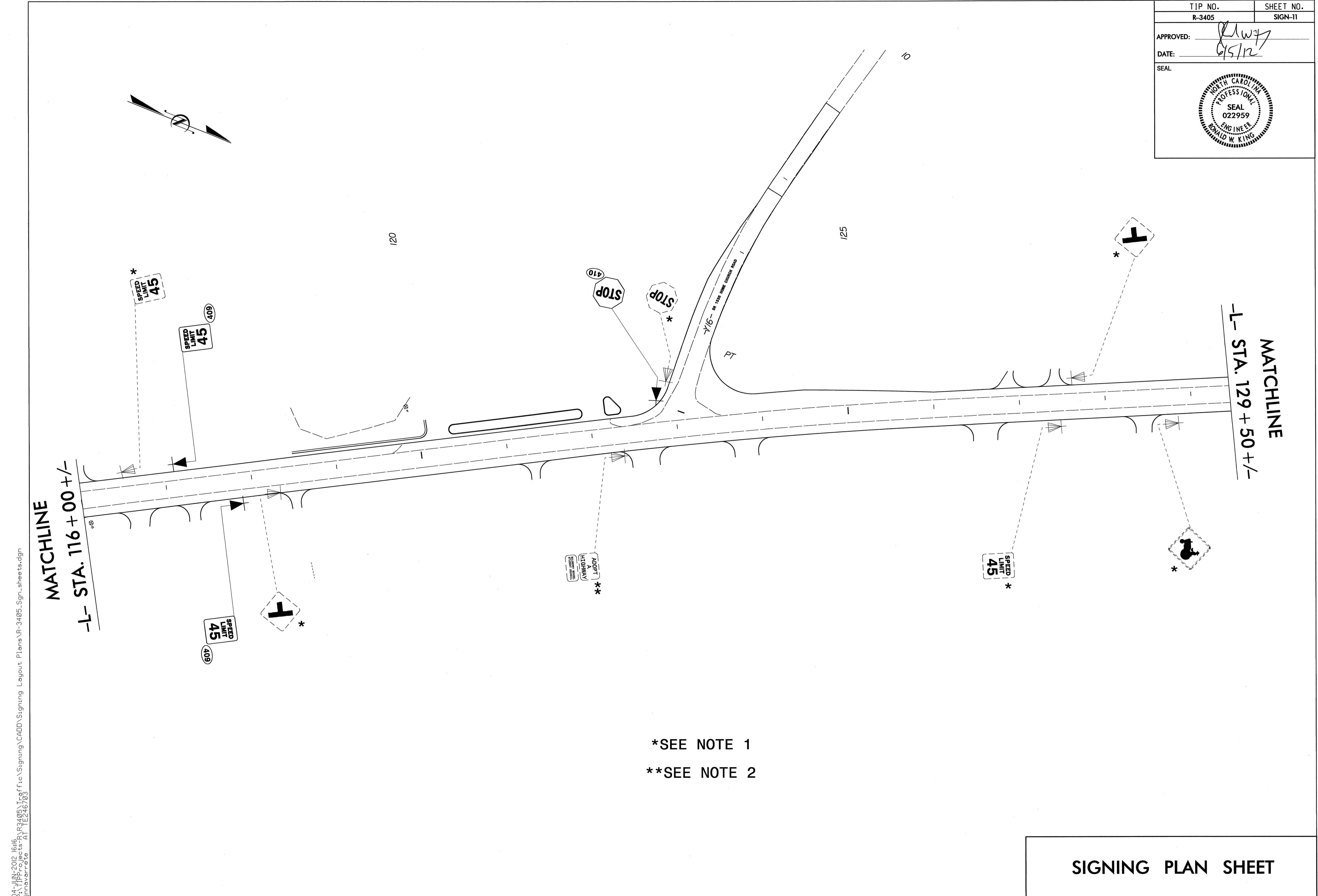

TIP NO. R-3405	SHEET NO. SIGN-11
APPROVED: <i>[Signature]</i>	
DATE: <i>9/5/12</i>	
SEAL	



\*SEE NOTE 1

\*\*SEE NOTE 2

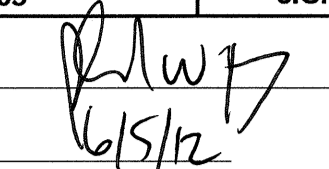
SIGNING PLAN SHEET

TIP NO. R-3405	SHEET NO. SIGN-12
APPROVED: 	
DATE: 6/5/12	
SEAL	
	

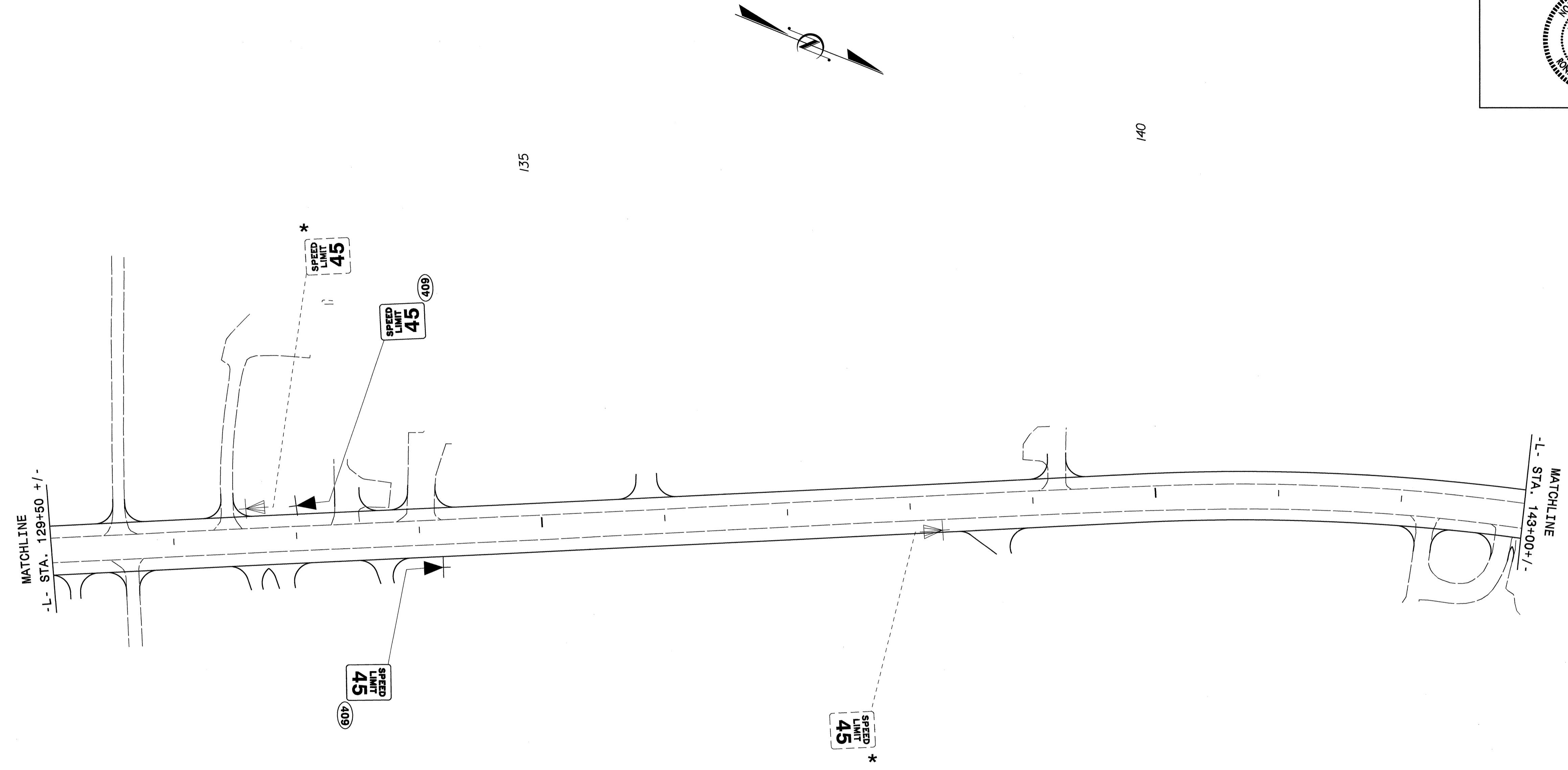

\*SEE NOTE 1

SIGNING PLAN SHEET

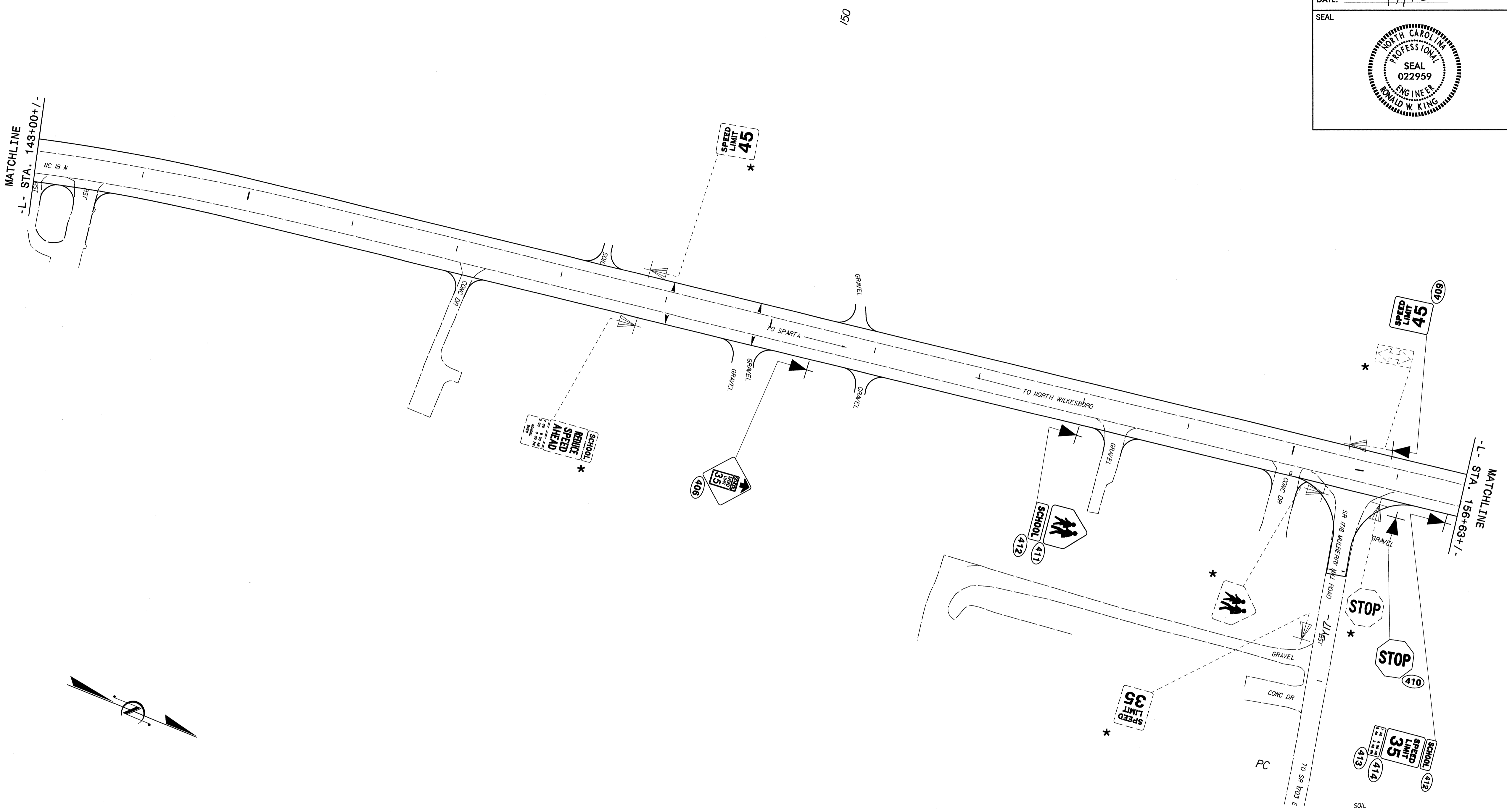

TIP NO. R-3405	SHEET NO. SIGN-13
APPROVED: <i>[Signature]</i>	
DATE: 6/5/12	
SEAL	
	



\*SEE NOTE 1

**SIGNING PLAN SHEET**

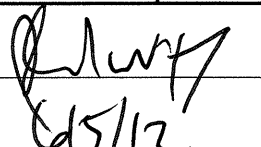
04 JUN 2012 16:17  
 C:\Users\jking\Documents\Projects\2012\20120603\Signing\Layout\Plans\R-3405\_Signing\Layout\Signing\CADD\Signing\Layout\Plans\R-3405\_Signing.sheets.dgn  
 jking

TIP NO. R-3405	SHEET NO. SIGN-14
APPROVED: 	
DATE: 6/5/12	
SEAL	
	

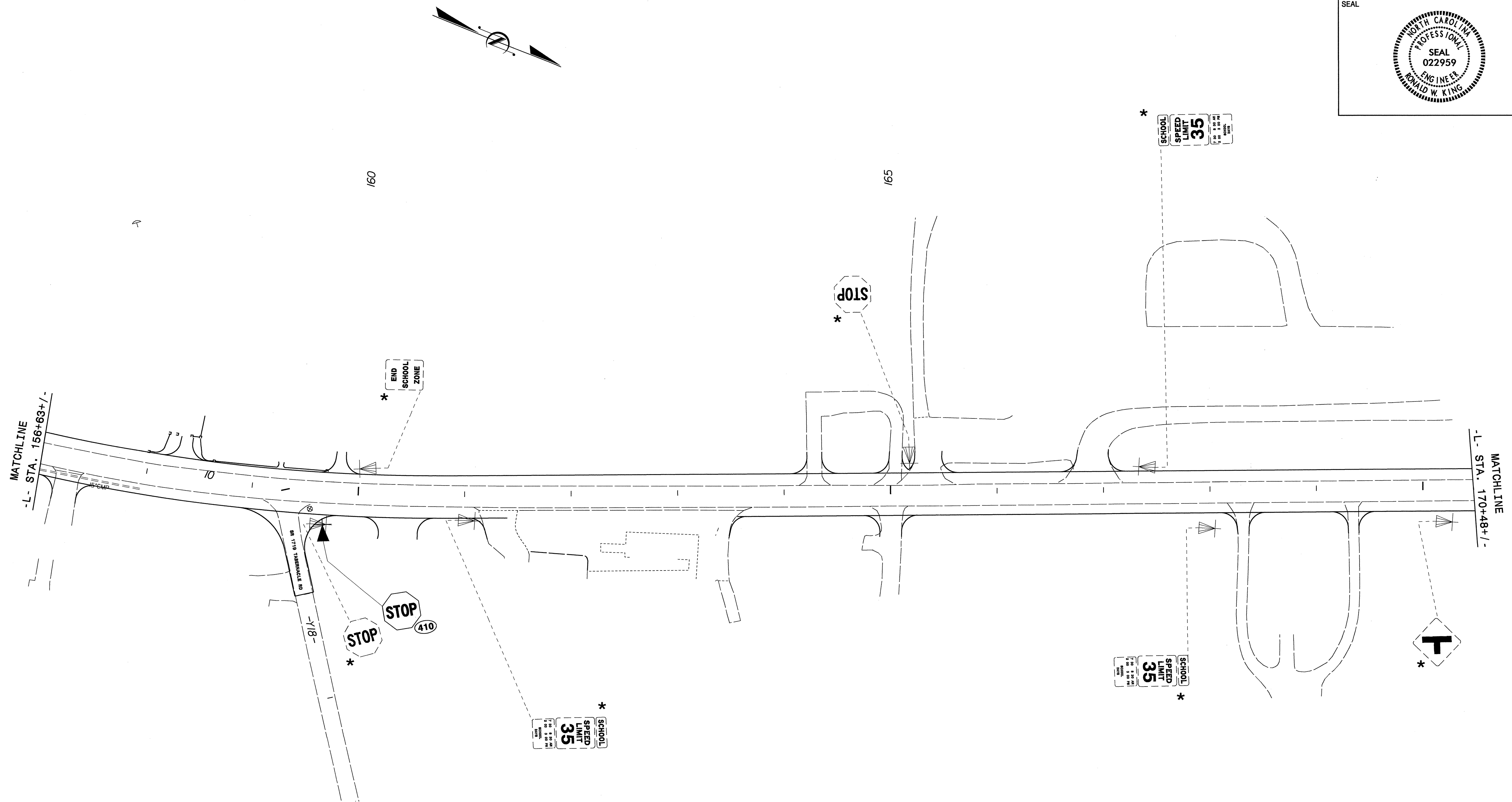

\*SEE NOTE 1

SIGNING PLAN SHEET

04 JUN 2012 16:17  
 C:\Users\jking\Documents\Projects\3405\Signing\CADD\Signing Layout Plans\R-3405\_Sgn\_sheets.dgn  
 jking

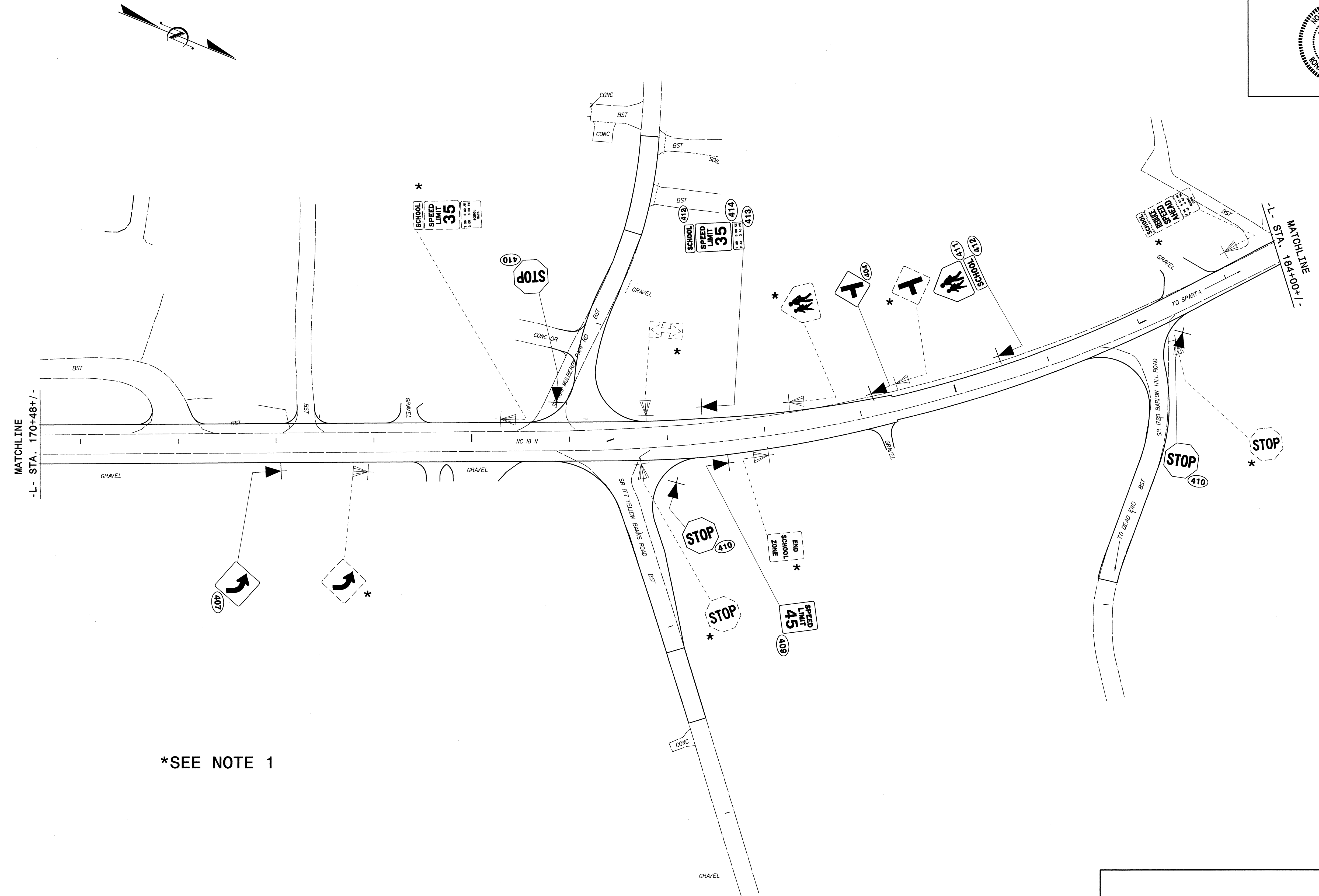
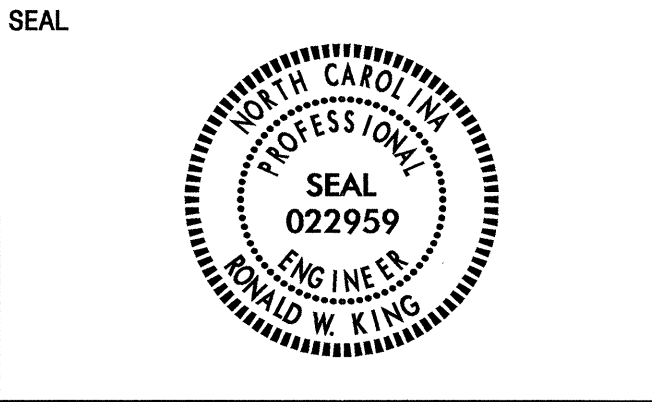

APPROVED: *[Signature]*  
 DATE: 8/12/12



\*SEE NOTE 1

**SIGNING PLAN SHEET**

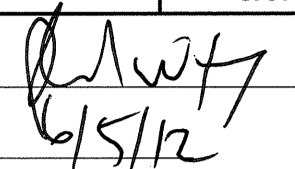
04 July 2012 16:17:03 R3405\_Traffic\_Signing\_Layout\_Plans\R-3405\_Sgn\_sheets.dgn  
 Unsaved AT 12:16:03

TIP NO. R-3405	SHEET NO. SIGN-16
APPROVED: 	
DATE: 6/5/12	
SEAL	
	

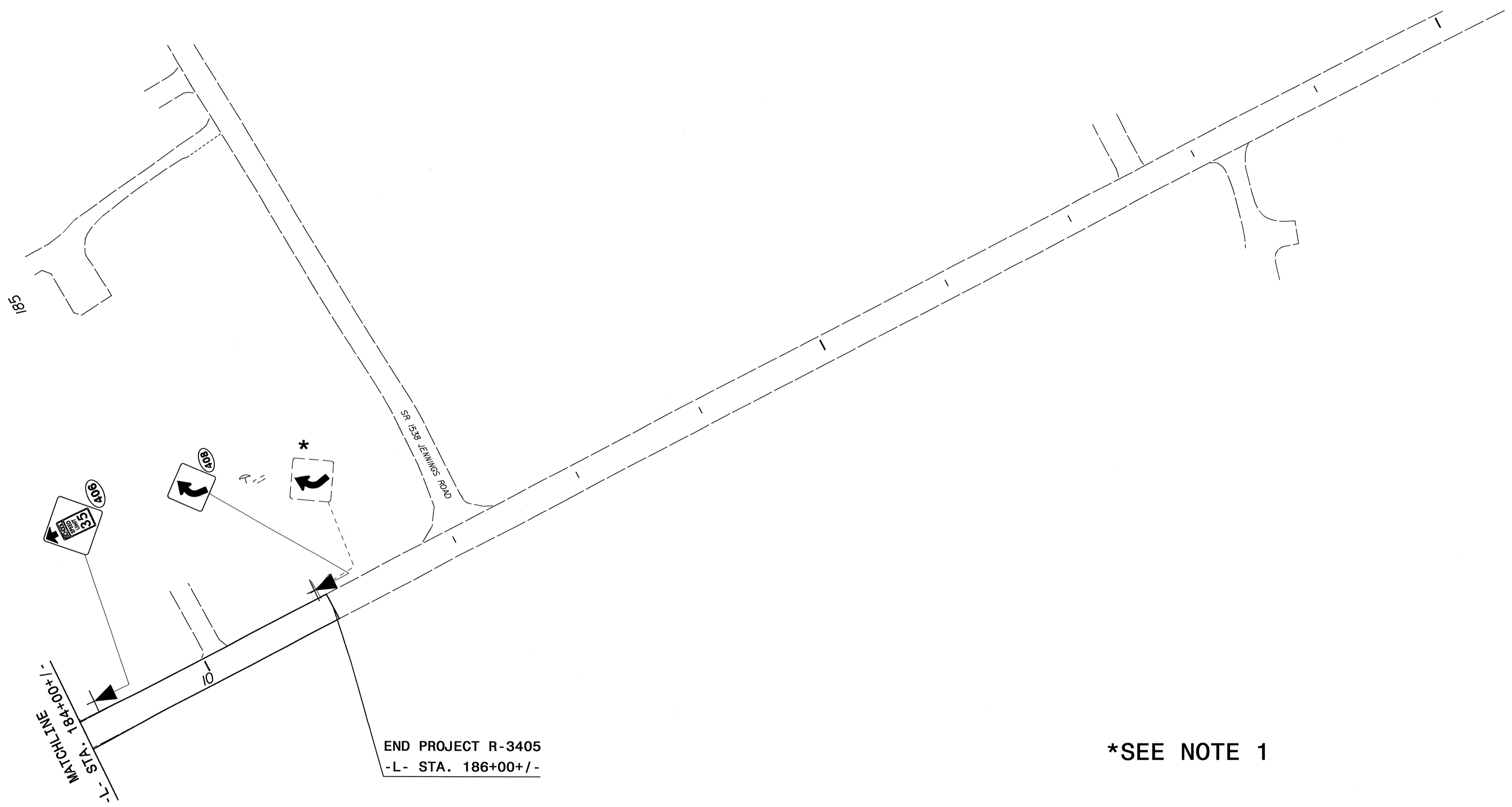
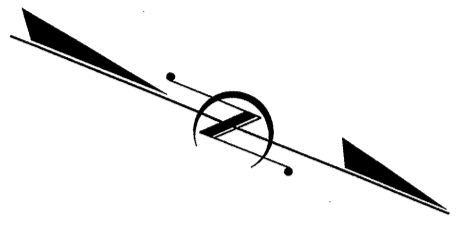

04 July 2012 16:18  
 J:\Projects\2012\1618\Projects\12216703\Signing\Layout Plans\R-3405\_Sgn\_sheets.dgn  
 Unsaved

SIGNING PLAN SHEET