

CONTRACT No.: C202837 T.I.P.: R-2554A

**STATE OF NORTH CAROLINA
 DEPARTMENT OF TRANSPORTATION**

**PAVEMENT MARKING PLAN
 WAYNE COUNTY**

LOCATION: GOLDSBORO BYPASS 70 FROM WEST OF NC 581 TO EAST OF SR 1300 (SALEM CHURGH ROAD)

TIP NO. R-2554A	SHEET NO. PMP-1
APPROVED:	
DATE: 2-1-12	

GENERAL NOTES

THE FOLLOWING GENERAL NOTES APPLY AT ALL TIMES FOR THE DURATION OF THE CONSTRUCTION PROJECT, EXCEPT WHEN OTHERWISE NOTED IN THE PLAN, OR DIRECTED BY THE ENGINEER.

- A) INSTALL PAVEMENT MARKINGS AND PAVEMENT MARKERS ON THE FINAL SURFACE AS FOLLOWS:
- | ROAD NAME | MARKING | MARKER |
|--------------------------------------|--|------------------|
| US 70, -Y- LINES,
RAMPS AND LOOPS | THERMOPLASTIC | SNOWFLOWABLE |
| CONCRETE BRIDGE DECKS | POLYUREA
(HIGHLY REFLECTIVE ELEMENT)
THERMOPLASTIC | PERMANENT RAISED |
- B) TIE PROPOSED PAVEMENT MARKING LINES TO EXISTING PAVEMENT MARKING LINES.
- C) REMOVE/REPLACE ANY CONFLICTING/DAMAGED PAVEMENT MARKINGS AND MARKERS.
- D) PASSING ZONES WILL BE DETERMINED IN THE FIELD AND MUST BE APPROVED BY THE ENGINEER.
- E) STOPBAR LOCATION AT NON-SIGNALIZED INTERSECTIONS MAY BE ADJUSTED AS DIRECTED BY THE ENGINEER.
- F) REMOVE ALL RESIDUE AND SURFACE LAITANCE BY ACCEPTABLE METHODS ON THE BRIDGE DECK(S) PRIOR TO PLACING POLYUREA AND THERMOPLASTIC PAVEMENT MARKING.

ROADWAY STANDARD DRAWING

THE FOLLOWING ROADWAY STANDARDS AS APPEAR IN "ROADWAY STANDARD DRAWINGS" - PROJECT SERVICES UNIT - N.C. DEPARTMENT OF TRANSPORTATION - RALEIGH, N.C., DATED JULY 2006 ARE APPLICABLE TO THIS PROJECT AND BY REFERENCE HEREBY ARE CONSIDERED A PART OF THESE PLANS:

STD. NO.	TITLE
1205.01	PAVEMENT MARKINGS - LINE TYPES AND OFFSETS
1205.02	PAVEMENT MARKINGS - 2 LANE AND MULTILANE ROADWAYS
1205.03	PAVEMENT MARKINGS - INTERCHANGES
1205.04	PAVEMENT MARKINGS - INTERSECTIONS
1205.05	PAVEMENT MARKINGS - TURN LANES
1205.06	PAVEMENT MARKINGS - LANE DROPS
1205.08	PAVEMENT MARKINGS - SYMBOL AND WORD MESSAGES
1205.09	PAVEMENT MARKINGS - PAINTED ISLANDS
1205.12	PAVEMENT MARKINGS - BRIDGES
1250.01	PAVEMENT MARKER SPACING
1251.01	RAISED PAVEMENT MARKERS - TEMPORARY AND PERMANENT
1253.01	SNOWFLOWABLE RAISED PAVEMENT MARKERS
1261.01	GUARDRAIL AND BARRIER DELINEATOR SPACING
1261.02	GUARDRAIL AND BARRIER DELINEATOR TYPES
1262.01	GUARDRAIL END DELINEATION
1264.01	OBJECT MARKERS
1264.02	PLACEMENT OF OBJECT MARKERS

PLAN PREPARED BY: N.C.D.O.T. SIGNING AND DELINEATION SECTION

<u>A. ALQUDWAH, P.E.</u>	SIGNING & DELINEATION REGIONAL ENGINEER
<u>D. M. EATON</u>	SIGNING & DELINEATION DESIGN ENGINEER

INDEX

SHEET NO.	DESCRIPTION
PMP-1	PAVEMENT MARKING PLAN TITLE SHEET, NOTES AND APPLICABLE ROADWAY STANDARD SHEET NUMBERS.
PMP-2	PAVEMENT MARKING SCHEDULE AND LEGEND
PMP-3-15	PAVEMENT MARKING DETAIL SHEETS

**PAVEMENT
MARKING SCHEDULE**

THERMOPLASTIC(100MM, 2.3MM)

- TA WHITE EDGELINE
- TB YELLOW EDGELINE

THERMOPLASTIC(100MM, 3.1MM)

- TC 3 M. WHITE SKIP
- TD .6 M. - 4 M./SP WHITE MINISKIP
- TE WHITE SOLID LANE LINE
- TI YELLOW DOUBLE CENTER

THERMOPLASTIC(150MM, 2.3MM)

- T6 WHITE EDGELINE
- T7 YELLOW EDGELINE

THERMOPLASTIC(150MM, 3.1MM)

- TJ 3 M. WHITE SKIP
- TK .6 M. - 4 M./SP WHITE MINISKIP
- TL WHITE SOLID LANE LINE

THERMOPLASTIC(200MM, 2.3MM)

- TP WHITE GORELINE
- TQ WHITE DIAGONAL
- TT YELLOW DIAGONAL

THERMOPLASTIC(300MM, 2.3MM)

- TY WHITE GORELINE

THERMOPLASTIC(600MM, 3.1MM)

- T2 WHITE STOPBAR

THERMOPLASTIC PAVEMENT MARKING CHARACTER (3.1MM)

- UI ALPHANUMERIC CHAR.

THERMOPLASTIC PAVEMENT MARKING SYMBOLS (2.3MM)

- UA LEFT TURN ARROW
- UB RIGHT TURN ARROW
- UC STRAIGHT ARROW
- UD COMBO.STRAIGHT/LEFT
- UE COMBO.STRAIGHT/RIGHT
- UP MERGE ARROW

POLYUREA (100MM) Highly Reflective Elements

- VA WHITE EDGELINE
- VC 3 M. WHITE SKIP
- VD .6 M. - 4 M./SP WHITE MINISKIP
- VI YELLOW DOUBLE CENTER

POLYUREA (150MM) Highly Reflective Elements

- V6 WHITE EDGELINE
- V7 YELLOW EDGELINE
- VJ 3 M. WHITE SKIP

MARKERS

PERMANENT RAISED PAVEMENT MARKERS

- MA YELLOW & YELLOW
- MB CRYSTAL & RED

MARKERS

SNOWPLOWABLE RAISED PAVEMENT MARKERS

- ME YELLOW & YELLOW
- MF CRYSTAL & RED

**SYMBOL AND PAVEMENT
MARKING LEGEND**

THERMOPLASTIC

- ↶ (UA) LEFT TURN ARROW
- ↷ (UB) RIGHT TURN ARROW
- ← (UC) STRAIGHT ARROW
- ↖ (UD) COMBO STRAIGHT/LEFT ARROW
- ↗ (UE) COMBO STRAIGHT/RIGHT ARROW
- ONLY (UI) ALPHANUMERIC SYMBOL
- ↵ (UP) MERGE ARROW

- (T2) WHITE STOPBAR
- (T6) WHITE EDGELINE
- (T7) YELLOW EDGELINE
- (TA) WHITE EDGELINE
- (TB) YELLOW EDGELINE
- (TC) 3 M WHITE SKIP
- (TD) .6 M - 4 M/SP WHITE MINISKIP
- (TE) WHITE SOLID LANE LINE
- (TI) YELLOW DOUBLE CENTER
- (TJ) 3M WHITE SKIP 150MM
- (TK) .6 M - 4 M/SP WHITE MINISKIP 150MM
- (TL) WHITE SOLID LANE LINE
- (TN) WHITE GORELINE 200MM
- (TO) WHITE DIAGONAL
- (TP) YELLOW DIAGONAL
- (TS) WHITE GORELINE

POLYUREA

- (V6) WHITE EDGELINE 150MM
- (V7) YELLOW EDGELINE 150MM
- (VA) WHITE EDGELINE
- (VC) 3 M WHITE SKIP
- (VD) .6 M - 4 M/SP WHITE MINISKIP
- (VI) YELLOW DOUBLE CENTER
- (VJ) 3M WHITE SKIP 150MM

**SYMBOL AND PAVEMENT
MARKING LEGEND**

PAVEMENT MARKERS

- (MB) CRYSTAL & RED
- (MA) YELLOW & YELLOW
- (ME) YELLOW & YELLOW
- (MF) CRYSTAL & RED

TIP NO. R-2554A	SHEET NO. PMP-2
APPROVED: <i>John D. [Signature]</i>	
DATE: 1-31-12	
SEAL	

**PAVEMENT MARKING SCHEDULE
AND LEGEND**



TIP NO. R-2554A	SHEET NO. PMP-3
APPROVED: <i>[Signature]</i>	
DATE: 1-31-12	
SEAL	

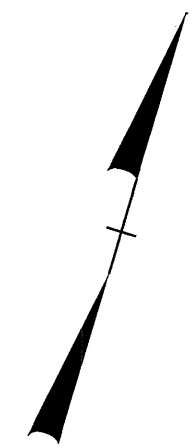
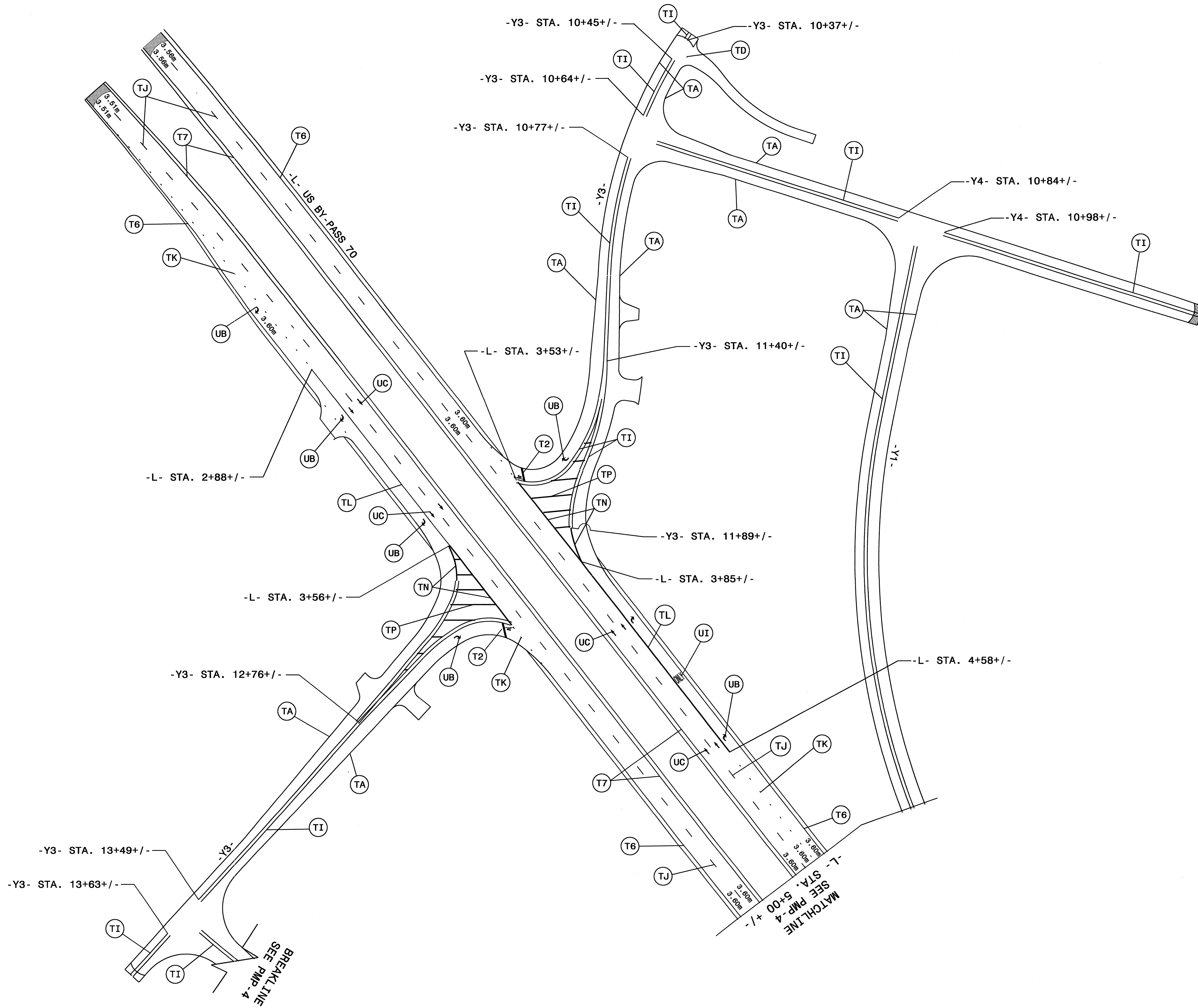

PAVEMENT MARKING DETAIL



TIP NO. R-2554A	SHEET NO. PMP-4
APPROVED: <i>[Signature]</i>	
DATE: 2-1-12	
SEAL	

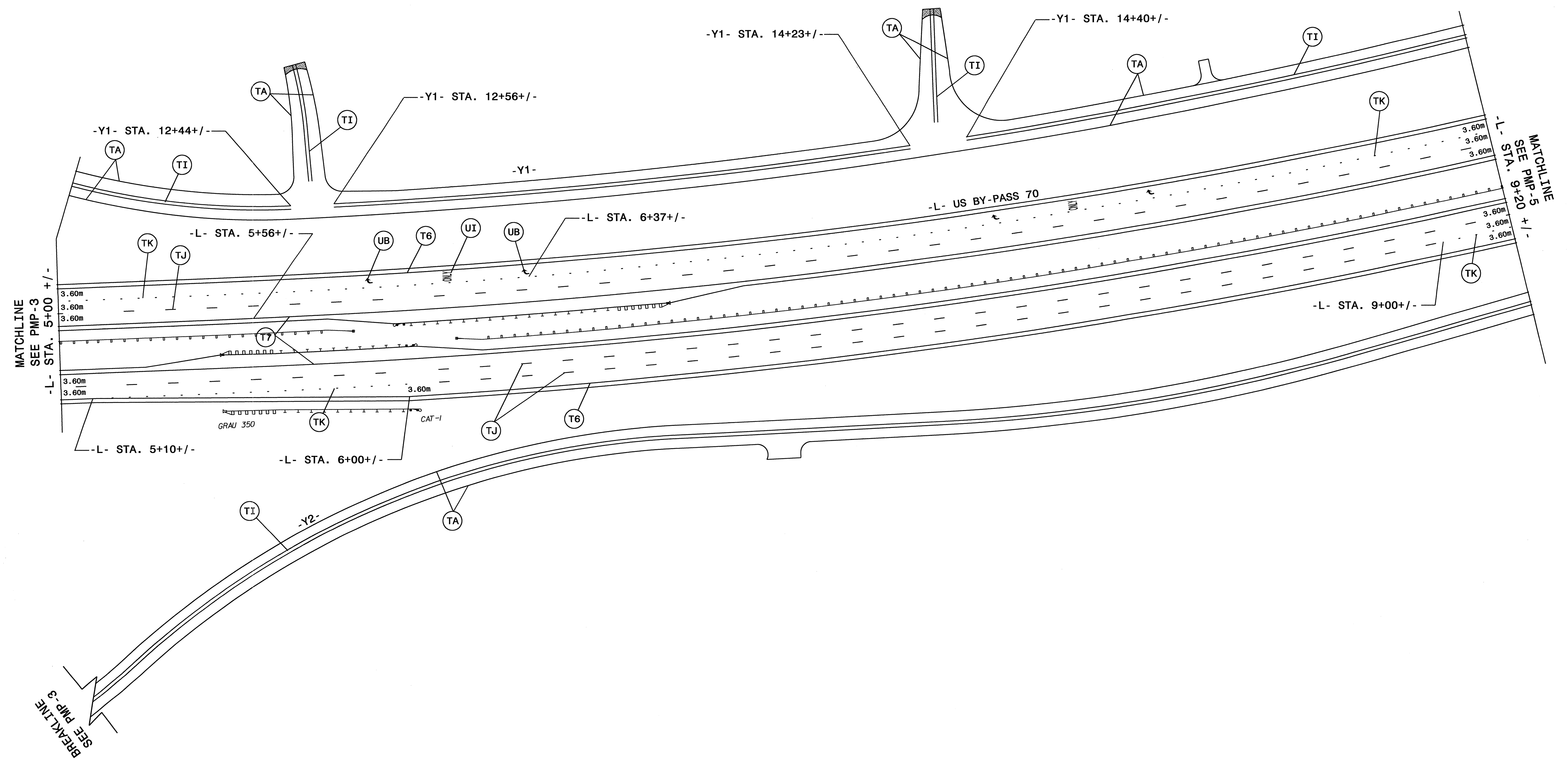
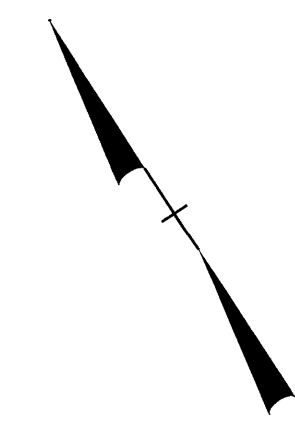

PAVEMENT MARKING DETAIL



TIP NO. R-2554A	SHEET NO. PMP-5
APPROVED: <i>[Signature]</i>	
DATE: 2-1-12	

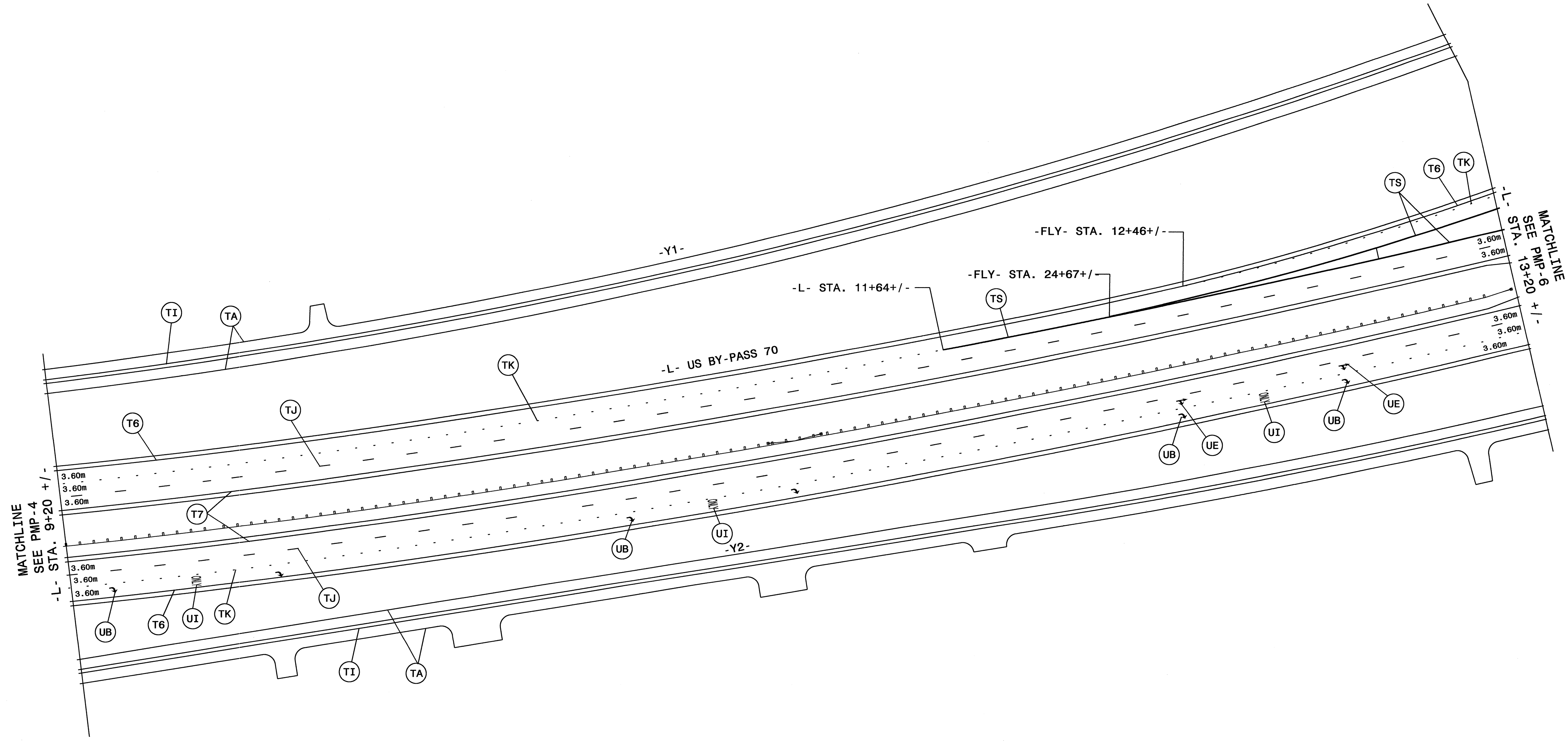
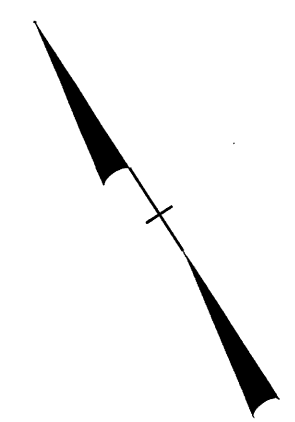
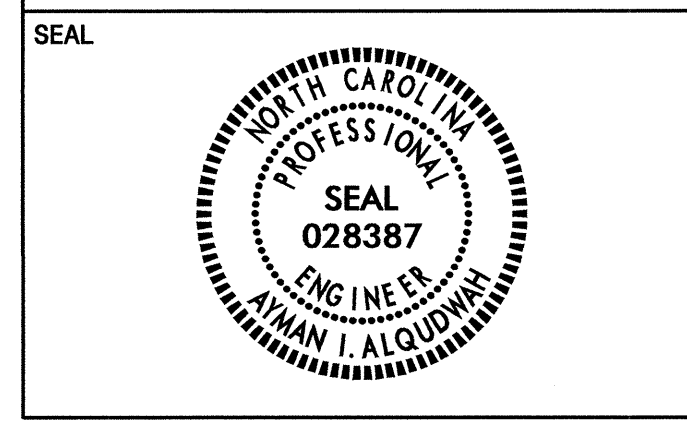

PAVEMENT MARKING DETAIL



TIP NO. R-2554A	SHEET NO. PMP-6
APPROVED: <i>[Signature]</i>	
DATE: 2-1-12	

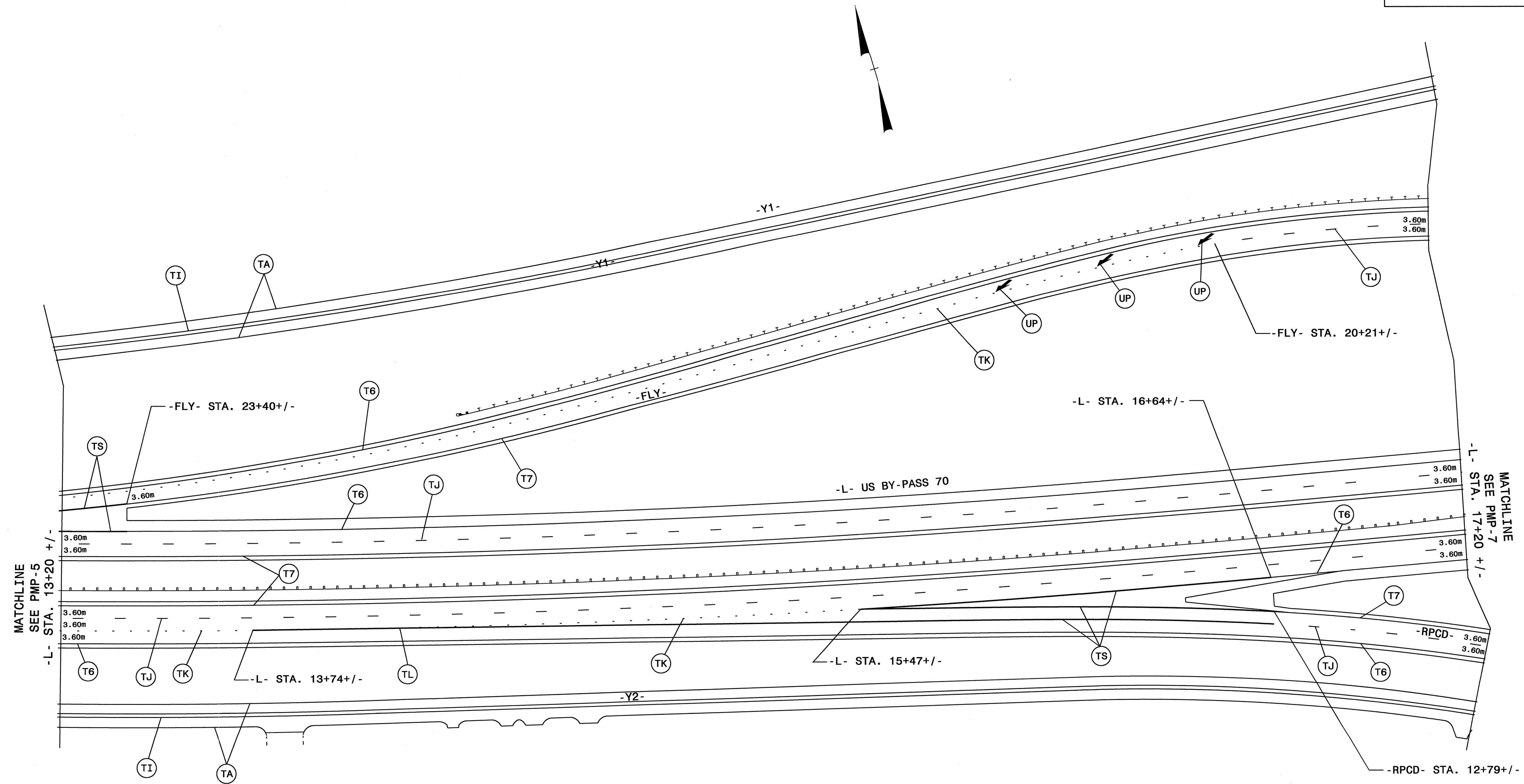
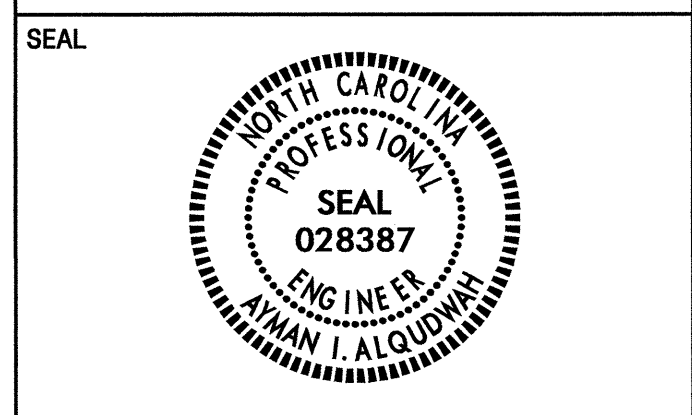

PAVEMENT MARKING DETAIL



TIP NO. R-2554A	SHEET NO. PMP-7
APPROVED: <i>[Signature]</i>	
DATE: 2-1-12	
SEAL	

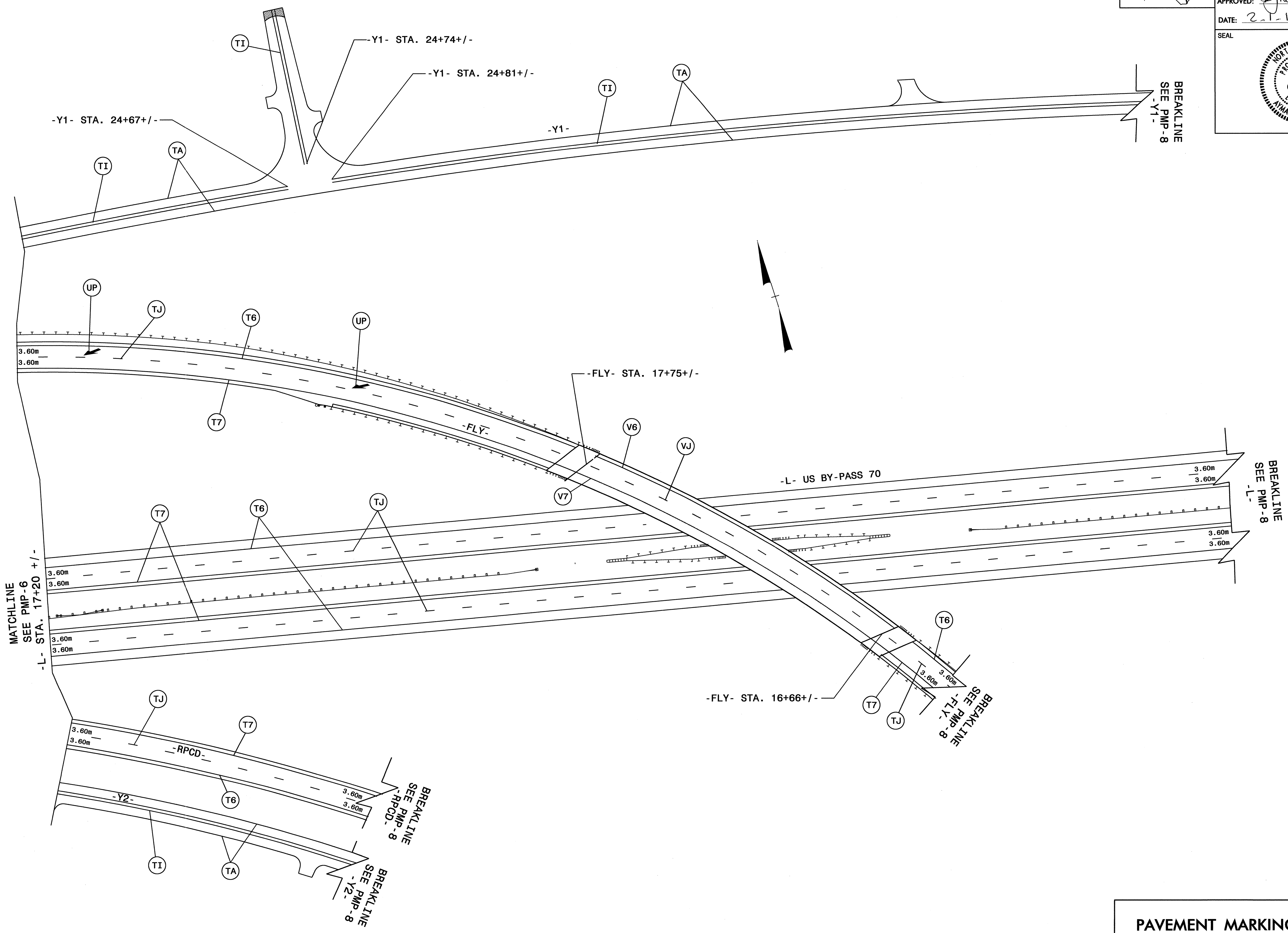

PAVEMENT MARKING DETAIL



TIP NO. R-2554A	SHEET NO. PMP-8
APPROVED: <i>Walter J. Alquist</i>	
DATE: 2-1-12	

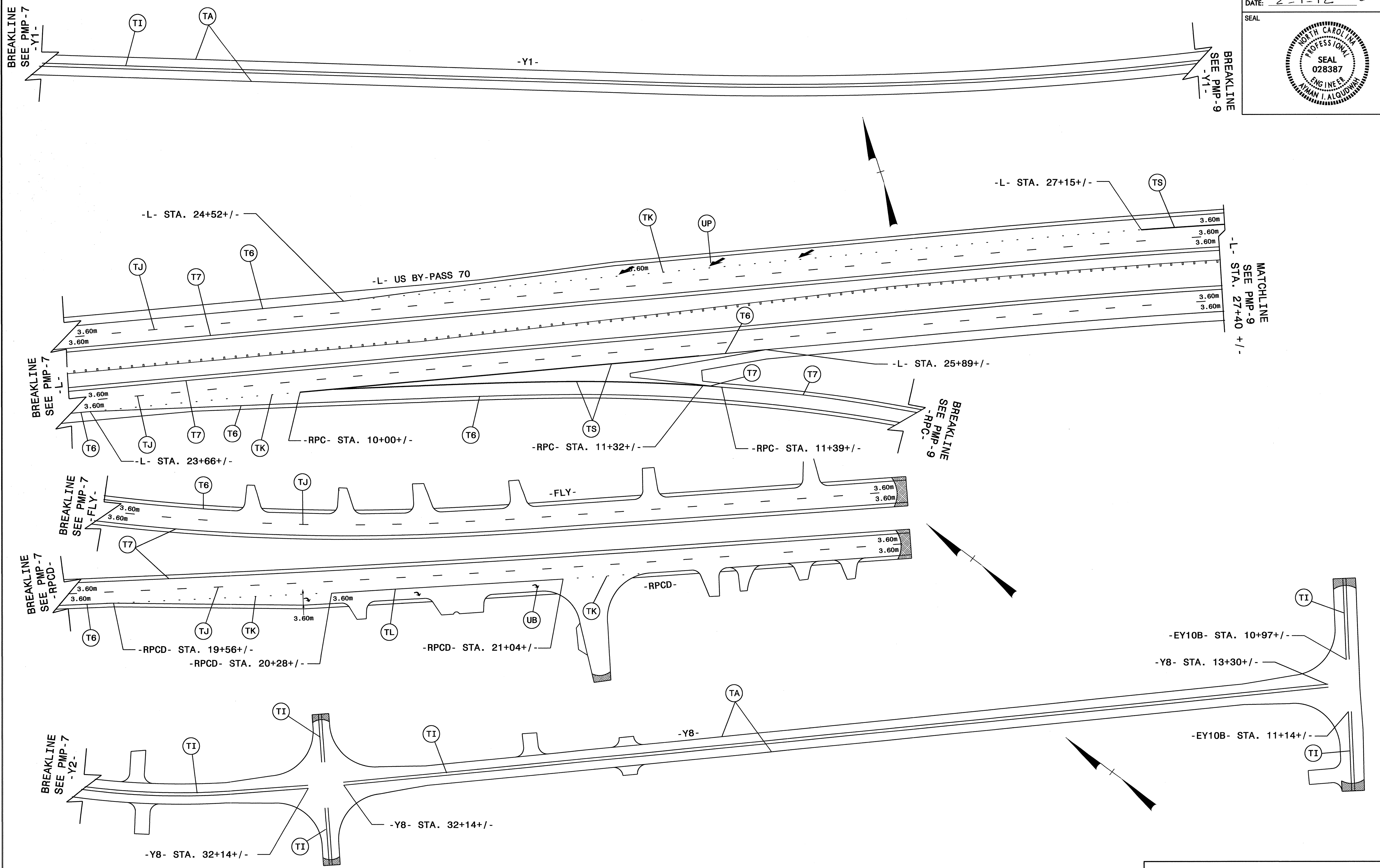

PAVEMENT MARKING DETAIL



TIP NO. R-2554A	SHEET NO. PME-9
APPROVED: <i>[Signature]</i>	
DATE: 2-1-12	
SEAL	

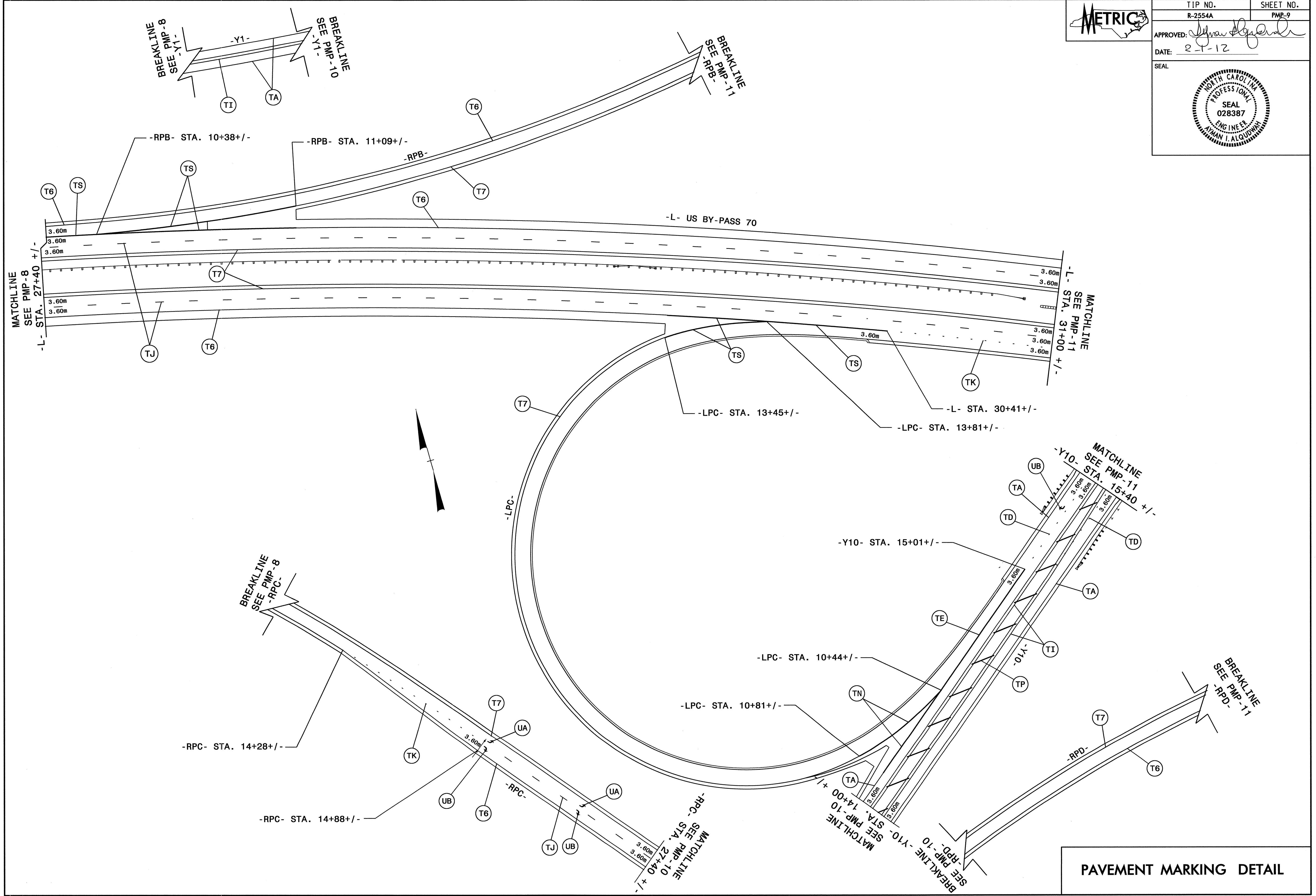

PAVEMENT MARKING DETAIL



TIP NO. R-2554A	SHEET NO. PMP-10
APPROVED: <i>[Signature]</i>	
DATE: 2-12-12	

SEAL

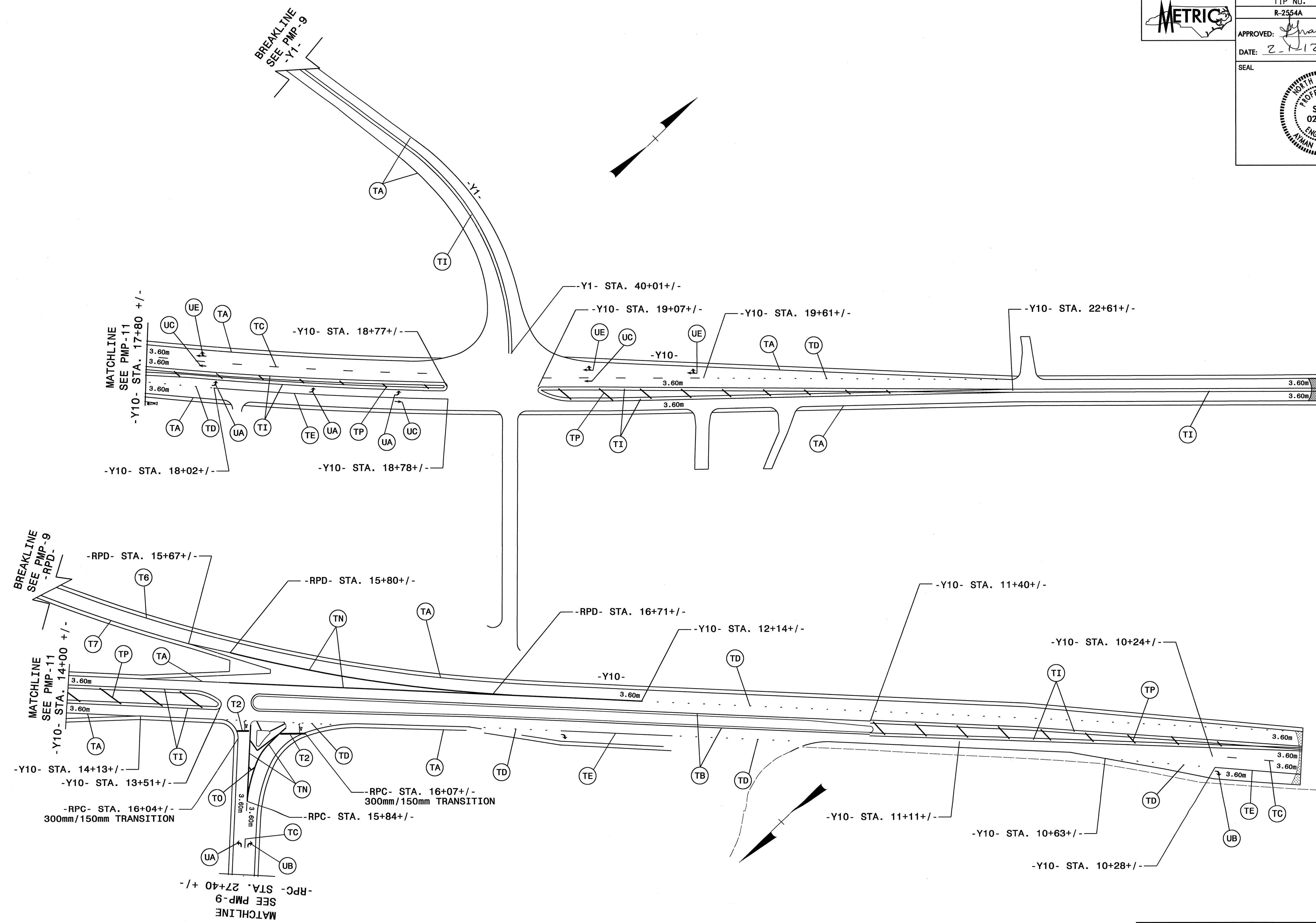

PAVEMENT MARKING DETAIL



TIP NO. R-2554A	SHEET NO. PMP-11
APPROVED: <i>[Signature]</i>	
DATE: 2-1-12	
SEAL	

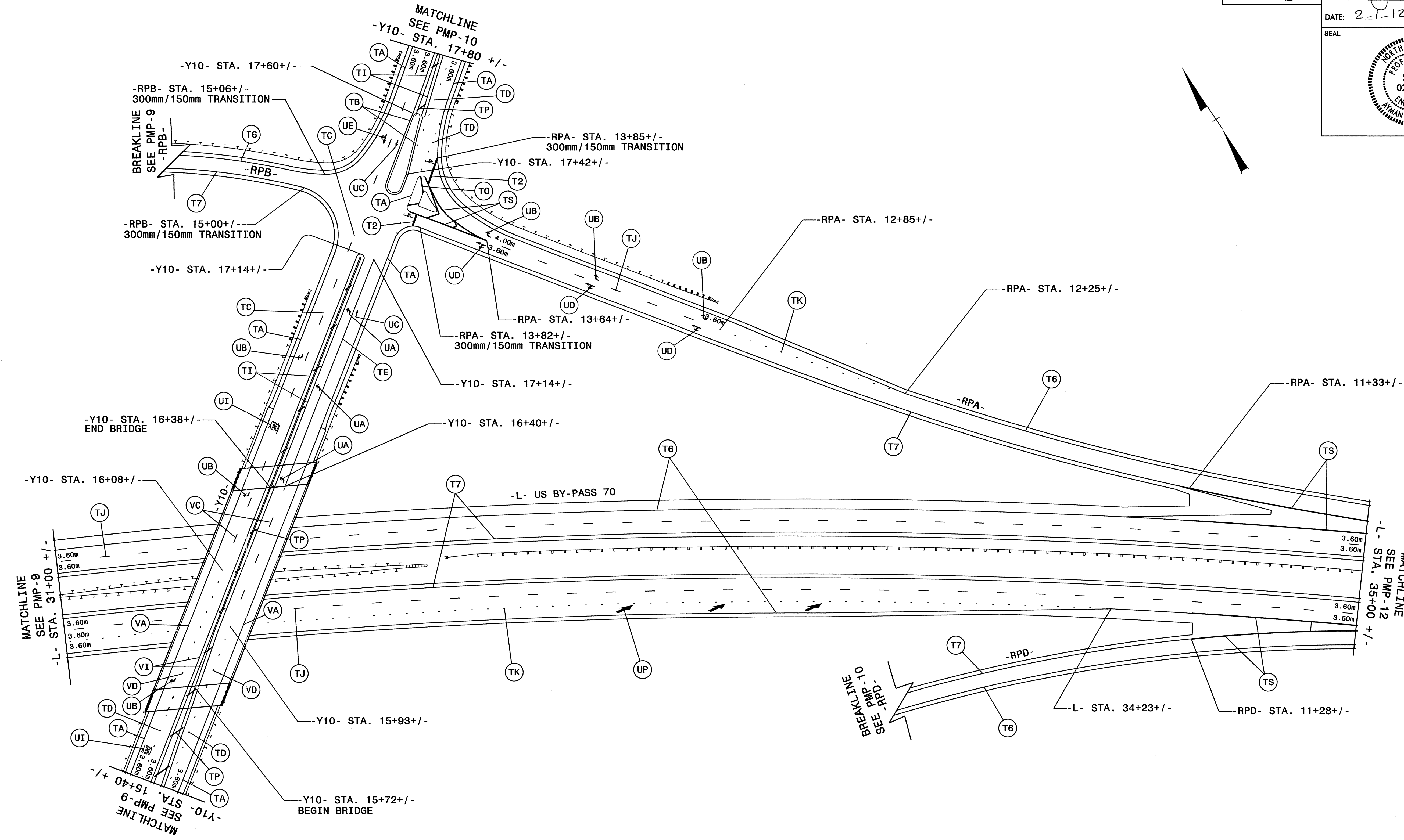

PAVEMENT MARKING DETAIL



TIP NO. R-2554A	SHEET NO. PMP-12
APPROVED: <i>[Signature]</i>	
DATE: 2-1-12	
SEAL	
	

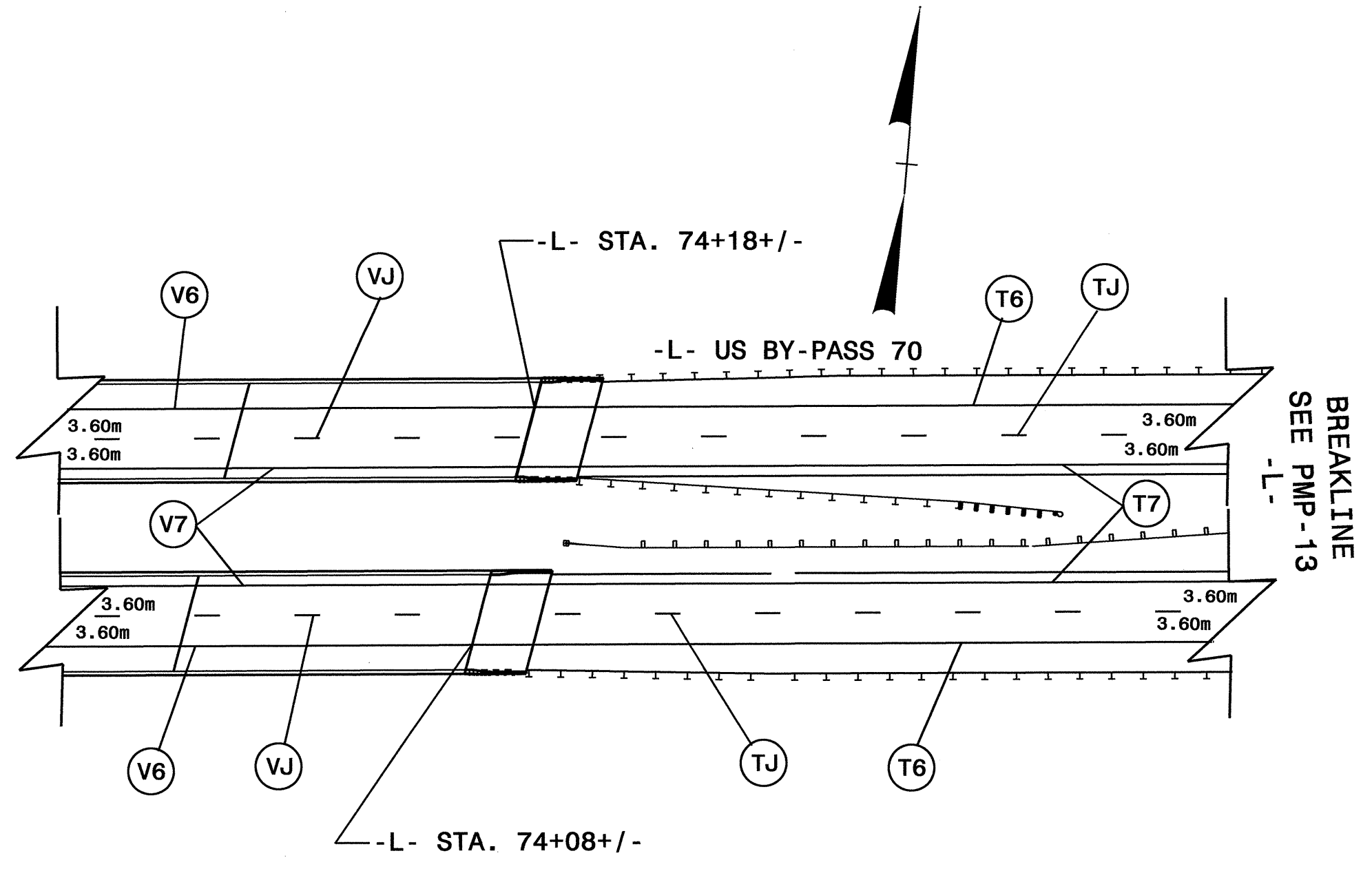
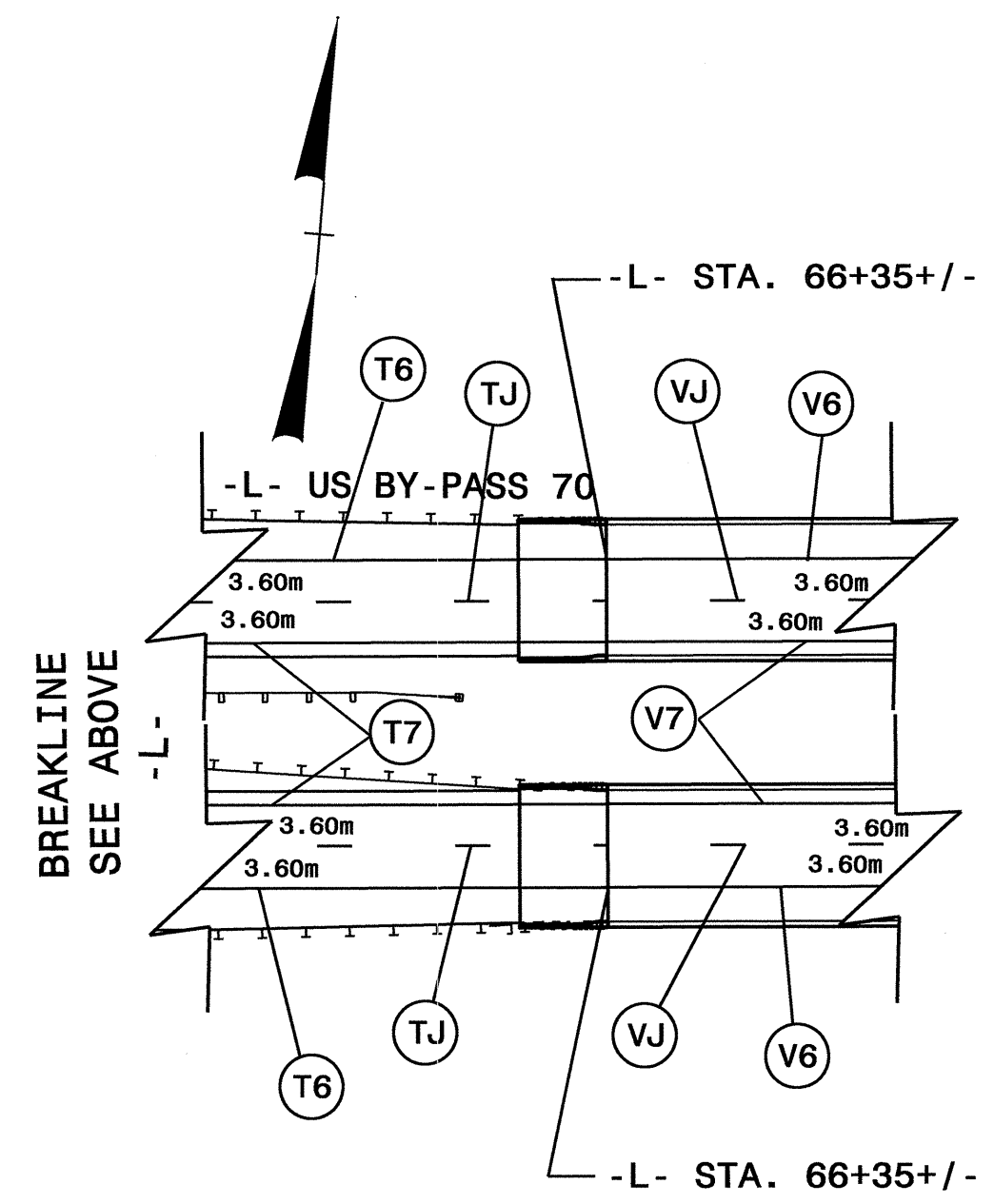
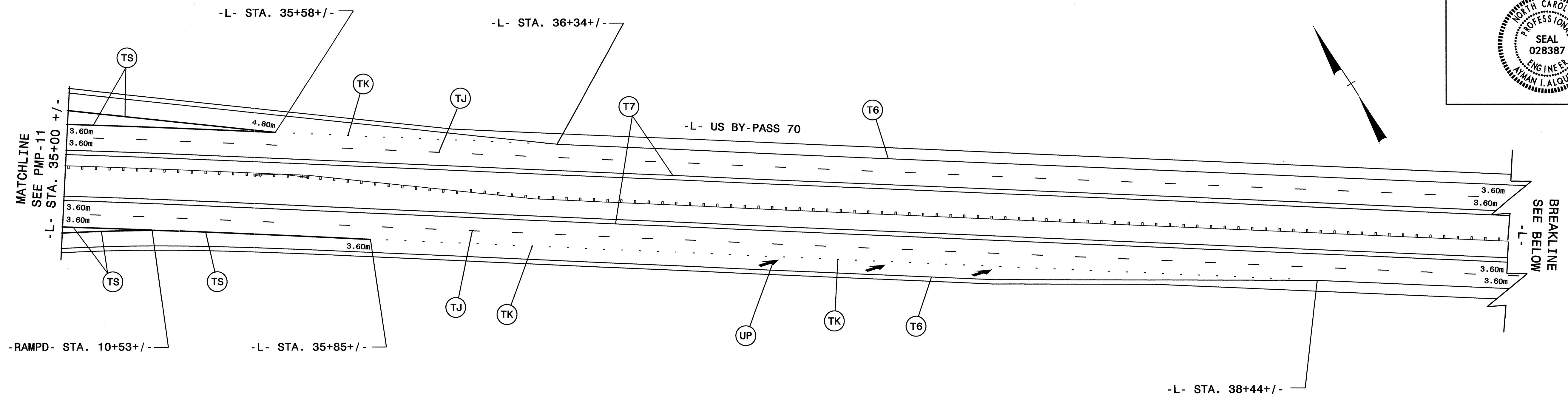

PAVEMENT MARKING DETAIL



TIP NO. R-2654A	SHEET NO. PMP-13
APPROVED: <i>[Signature]</i>	
DATE: 2-1-12	
SEAL	

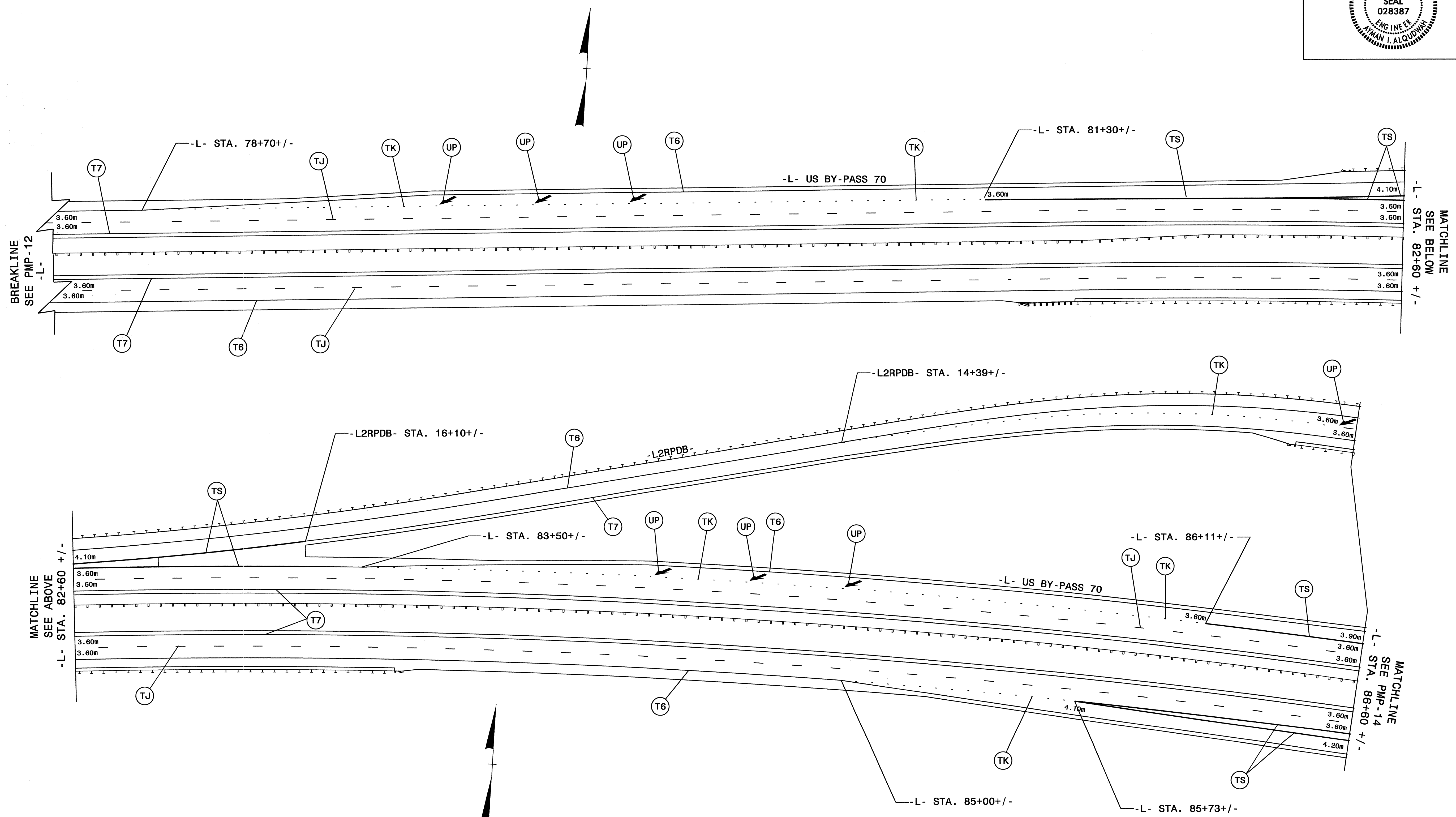



TIP NO. R-2554A	SHEET NO. PMP-14
APPROVED: <i>[Signature]</i>	
DATE: 2-1-12	
SEAL	

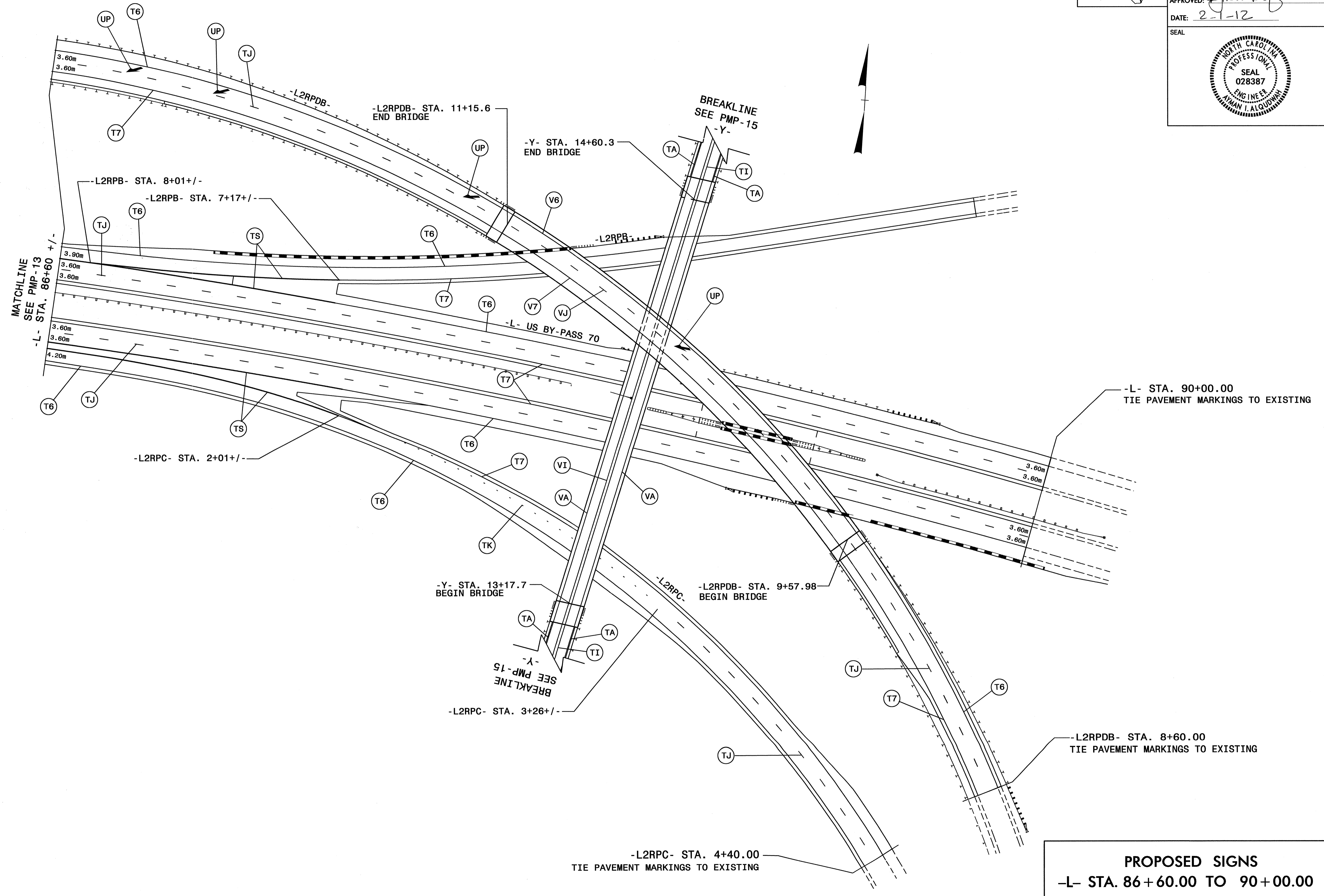

PROPOSED SIGNS
-L- STA. 86+60.00 TO 90+00.00



TIP NO. R-2554A SHEET NO. PMP-15

APPROVED: *Yman Alqudus*

DATE: 2-1-12

SEAL

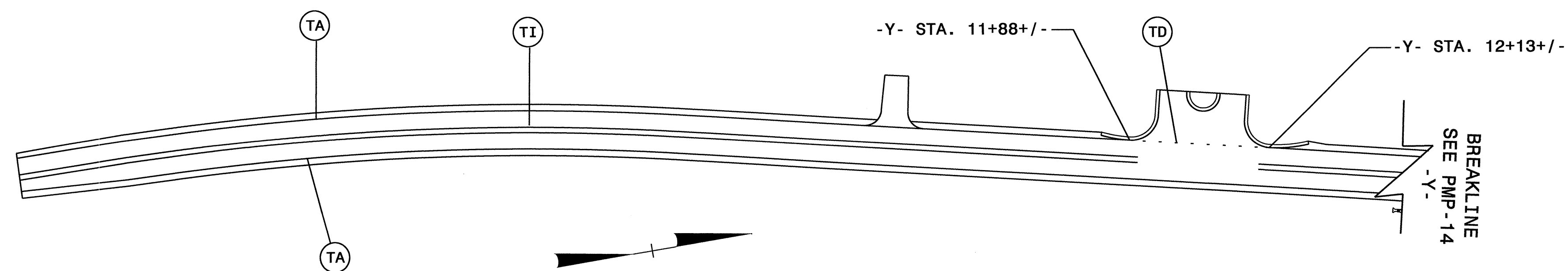
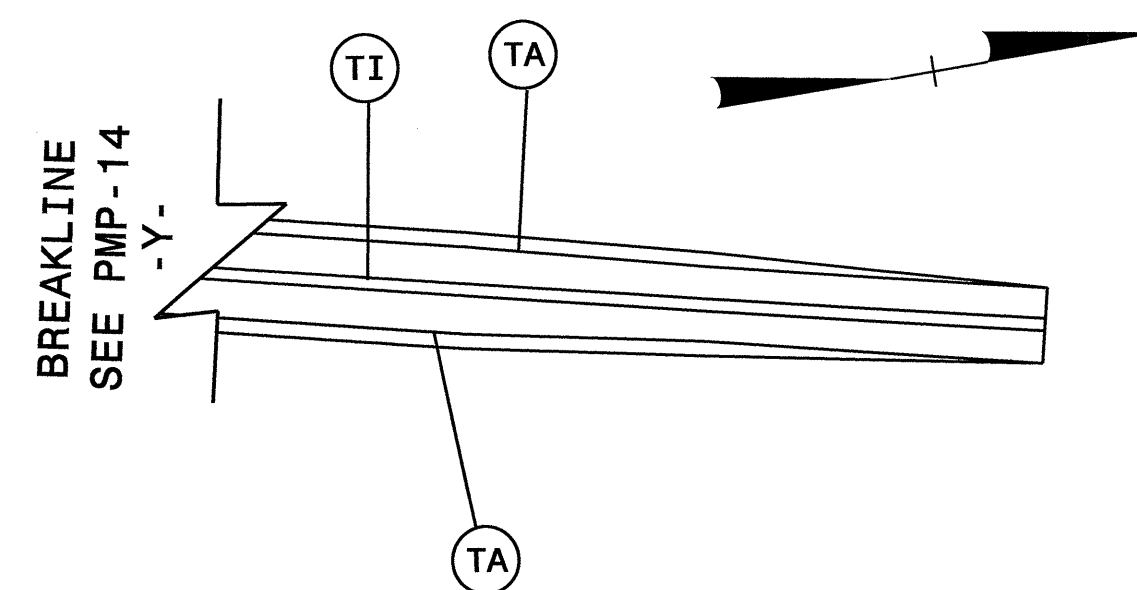

PAVEMENT MARKING DETAIL