

**TRAFFIC CONTROL:**

(10-21-08)

RWZ-1 Revised

Maintain traffic in accordance with Divisions 10, 11 and 12 of the *Standard Specifications* and the following provisions:

Use a lane closure (refer to the *Roadway Standard Drawings* Nos. 1101.02, 1101.11, 1110.02, 1130.01 and details for the Advance Work Zone signing in contract) or a slow-moving operation as shown in details of this contract. Use a moving operation only if the minimum speed maintained at all times is 3 mph with no stops that narrow or close a lane of travel. If the moving operation is progressing slower than 3 mph at any time, install a lane closure. Maintain the existing traffic pattern at all times, except in the immediate work zone where lane closures are allowed as determined by the Engineer.

Refer to Attached Details and the *Roadway Standard Drawings* Nos. 1101.02, 1101.03, 1101.04, 1101.05, 1101.11, 1110.01, 1110.02, 1115.01, 1130.01, 1135.01, 1145.01, 1150.01, 1165.01, 1170.01 and 1180.01 when closing a lane of travel in a stationary work zone such as pavement patching resurfacing, or pavement marking removal. Properly ballasted cones may be used instead of drums for lane closures during daylight hours. However, drums are required for the upstream taper portion of lane closures in all applications. The stationary work zone shall be a maximum of 3 miles in length at any given time unless otherwise directed by the Engineer. A pilot vehicle operation may be used in conjunction with flaggers and the appropriate pilot vehicle warning signing as directed by the Engineer. During periods of construction inactivity, return the traffic pattern to the existing alignment and remove or cover any work zone signs. When covering work zone signs, use an opaque material that prevents reading of the sign at night by a driver using high beam headlights. Use material, which does not damage the sign sheeting. Replace any obliterated markings as required by other sections of the *Standard Specifications* and the Engineer.

When personnel and/or equipment are working on the shoulder adjacent to an undivided facility and within 5 feet of an open travel lane, close the nearest open travel lane using the *Roadway Standard Drawings* No. 1101.02 unless the work area is protected by barrier or guardrail. When personnel and/or equipment are working on the shoulder, adjacent to a divided facility and within 10 feet of an open travel lane, close the nearest open travel lane using the *Roadway Standard Drawings* No. 1101.02 unless the work area is protected by barrier or guardrail. When personnel and/or equipment are working within a lane of travel of an undivided or divided facility, close the lane according to the traffic control plans, *Roadway Standard Drawings* or as directed by the Engineer. Conduct the work so that all personnel and/or equipment remain within the closed travel lane. Do not work simultaneously, on both sides of an open travel way, within the same location, on a two-lane, two-way road. Do not perform work involving heavy equipment within 15 feet of the edge of travel way when work is being performed behind a lane closure on the opposite side of the travel way. Perform work only when weather and visibility conditions allow safe operations as directed by the Engineer.

Do not exceed a difference of 2 inches in elevation between open lanes of traffic for nominal lifts of 1.5 inches. Install advance warning UNEVEN LANES signs (W8-11 at 48" X 48") 500 feet in advance and a minimum of once every half mile throughout the uneven area.

Backfill at a 6:1 slope up to the edge and elevation of existing pavement in areas adjacent to an open travel lane that has an edge of pavement drop-off as follows:

- (A) Drop-off that exceeds 2 inches on roadways with posted speed limits of 45 mph or greater
- (B) Drop-off that exceeds 3 inches on roadways with posted speed limit less than 45 mph.

Backfill the unacceptable drop-off with suitable compacted material, as approved by the Engineer, at no expense to the Department. This work is not considered part of shoulder reconstruction.

When utilizing a slow-moving operation for such items as pavement marking placement, pavement marker installation and pesticide spraying, the slow moving operation caravan shall consist, as a minimum, of the vehicles and devices shown on the Moving Operation Caravan Detail(s) herein. Traffic cones may be used when necessary to provide additional protection of wet pavement markings. Ballast all traffic cones so they will not be blown over by traffic.

Submit a written sequence of operation for all maps to the Engineer at the first pre-construction meeting for approval by the Engineer. Approved sequence can not be altered without written permission of the Engineer.

**Failure to comply with the following requirements will result in a suspension of all other operations:**

- 1. Before working on ANY MAP, the Contractor shall submit a written construction sequence for traffic control and construction lighting for ALL MAPS to the Engineer at the first pre-construction meeting and the sequence must be approved before closing a lane of traffic. The Contractor and Engineer will coordinate with the Traffic Management Unit for additional traffic control guidance.**
- 2. Coordinate the installation of items on Summary of Quantity spreadsheet and resurfacing operations such that these operations are completed in the order as agreed upon with the Engineer at the first pre-construction meeting. Refer to the Provisions, Typicals and Details unless otherwise directed by the Engineer.**
- 3. Once the Contractor has started work at a location, the Contractor should prosecute the work in a continuous and uninterrupted manner from the time he begins the work until completion and final acceptance unless determined otherwise by the Engineer.**
- 4. Obtain written approval of the Engineer before working in more than one location or setting up additional lane closures.**
- 5. Mainline pavement shall not be left milled, unmarked or uneven at the end of a paving season.**
- 6. Contractor shall mill and pave lanes in an order such that water shall not accumulate.**
- 7. Contractor shall complete the work shown on Typical # 4 & 6, in the order as agreed upon with the Engineer at the first pre-construction meeting.**

Notify the Engineer and Traffic Services at 704-982-1998 48 hours before milling or resurfacing will interfere with the existing Signal Loops. Loops may need to be placed in milled surface before resurfacing occurs. Coordinate all signal loop operations with the Engineer and Traffic Services.

Notify the Engineer 15 consecutive calendar days before resurfacing a bridge or its approaches. Patch and make repairs to bridge surface and its approaches before resurfacing occurs. Coordinate all operations on the bridge and its approaches with the Engineer.

Notify the Engineer 48 hours before resurfacing the areas of existing pavement that require patching. Patch these areas before resurfacing occurs. Allow full depth asphalt patching to cool to the point of supporting traffic without displacement or rutting before reopening closed lane. Coordinate the resurfacing operations of the patched areas with the Engineer.

During a resurfacing only operation, bring all newly resurfaced lanes to the same elevation within 72 hours for nominal lifts of 1.5 inches or less of asphalt course and by the end of each work day for nominal lifts of greater than 1.5 inches of asphalt course.

For partial or wheel track milling operations on two-way, two-lane facilities, mill and pave back by the end of each work day. For partial or wheel track milling operations on multi-lane facilities, the lane being milled may be left closed and paved back within 72 hours.

The following options are acceptable during Resurfacing and milling operations on two-way, two-lane facilities when the entire roadway or entire lane is to be milled:

**Mill the entire width of roadway and pave back within 72 hours.**

The following options are available during Resurfacing and milling operations on multi-lane facilities when all lanes or a single lane in one direction are to be milled:

**Mill the entire width of pavement for all lanes to be milled in any direction daily and pave back within 72 hours.**

When resurfacing facilities with ramps, resurface the ramp and gore area of the ramp as agreed upon with the Engineer. Place the transverse joint on the ramp at the terminal point of the gore unless the ramp is being resurfaced beyond this limit.

Slope the pavement at the beginning and ending of the daily milling operation as directed by the Engineer. Sweep and remove all milled material from the roadway as soon as the daily milling operation is completed. Continue milling operations until the particular section of roadway being milled is complete. Remove any existing pavement adjacent to the milled area that has been damaged, and replace with patch material as directed by the Engineer.

Maintain vehicular access in accordance with Section 1101-13 of the *Standard Specifications* using suitable backfill material approved by the Engineer.

Operate equipment and conduct operations in the same direction as the flow of traffic. Do not cross medians with equipment, except at properly designated interchanges.

Review and record the existing pavement markings and markers prior to resurfacing. Use the record of existing pavement markings and markers in accordance with the *Roadway Standard Drawings* to re-establish the proposed pavement markings and markers unless otherwise directed by the Engineer.

Provide appropriate lighting in accordance with Section 1413 of the *Standard Specifications*.

Remove existing pavement markers in preparation for paving. Repair any pavement damage due to existing pavement marker removal prior to the end of the work day. Dispose of existing pavement markers as directed by the Engineer. No direct payment will be made for this work, as it will be incidental to the paving operation.

Payment will be made for the traffic control items that have been included in the contract. No direct payment will be made for providing other traffic control as required herein, as the cost of same will be considered incidental to the work being paid for under those various traffic control items that have been included. Where the Contractor maintains traffic as required herein but no specific pay items have been included in the contract, all associated costs will be considered incidental to the work being paid for under the various items in the contract.

**WORK ZONE SIGNING:**

(10-21-08)

RWZ-3

**Description**

Install and maintain signing in accordance with Divisions 11 and 12 of the *Standard Specifications*, the *Roadway Standard Drawings* and the following provisions:

Furnish, install, maintain, and remove advance warning work zone signs and any required lane closure signing.

Furnish, install, and maintain general work zone warning signs for resurfacing and milling such as ROUGH ROAD (W8-8 at 48" X 48") (for milling only), UNEVEN LANES (W8-11 at 48" X 48"), LOW SHOULDER (W8-9 at 48" X 48"), LOW / SOFT SHOULDER (DOT No. 16-79860 at 48" X 48"), UNMARKED PAVEMENT AHEAD (DOT No. 116087130 at 48" X 48") and DO NOT PASS (R4-1 at 24" X 30"). When construction is completed in any area of the project, relocate signs to the next work site, as directed by the Engineer. Remove these signs at the completion of the project.

All work zone signs may be portable.

**Construction Methods**

**(A) General**

Install all warning work zone signs before beginning work on a particular map. If signs are installed three days prior to the beginning of work on a particular map, cover the signs until the work begins. Install each work zone warning sign separately and not on the same post or stand with any other sign except where an advisory speed plate or directional arrow is used.

**(B) Advance Warning Work Zone Signs**

Install advance warning work zone signs (see attached Details and the *Roadway Standard Drawings* Nos. 1101.02 and 1110.01 and advance signing details) prior to beginning of work and remove upon final completion of the project. If there is a period of construction inactivity longer than two weeks, remove or cover advance warning work zone signs. Uncover advance warning work zone signs no more than 3 days before work resumes. All other operations could be suspended upon failure to comply with the above requirements. Such suspended operations would not be resumed until the above requirements are fulfilled.

**(C) Lane Closure Work Zone Signs**

Install any required lane closure signing needed during the life of the project in accordance with the *Roadway Standard Drawings* Nos. 1101.02, 1101.11 and 1110.02.

**(D) General Work Zone Warning Signs**

Install general work zone warning signs for resurfacing and milling such as ROUGH ROAD (W8-8 at 48" X 48") (for milling only), UNEVEN LANES (W8-11 at 48" X 48"), LOW SHOULDER (W8-9 at 48" X 48") and LOW / SOFT SHOULDER (W8-9B at 48" X 48") at 1 mile intervals starting at a minimum of 500 feet in advance of the condition for both directions of travel (undivided roadways only) and at any other points determined by the Engineer.

Install the LOW SHOULDER (W8-9 at 48" X 48") or LOW / SOFT SHOULDER (DOT No. 16-79860 at 48" X 48") signs prior to any resurfacing in an area where shoulder construction will be performed.

Install general work zone warning signs such as UNMARKED PAVEMENT AHEAD (DOT No. 116087130 at 48" X 48") and DO NOT PASS (R4-1 at 24" X 30") alternately at 1/2 mile intervals starting at a minimum of 500 feet in advance of the condition for both directions of travel (undivided roadways only) and at any other points determined by the Engineer. Install signs prior to the obliteration of any pavement markings.

**Measurement and Payment**

Payment will be made for the work zone signing items that have been included in the contract. No direct payment will be made for providing other work zone signing as required herein, as the cost of same will be considered incidental to the work being paid for under those various work zone signing items that have been included. Where the Contractor provides work zone signing as required herein but no specific pay items have been included in the contract, all associated costs will be considered incidental to the work being paid for under the various items in the contract.

**TIME LIMITATION FOR PAVEMENT MARKINGS AND  
MARKERS ON NEWLY RESURFACED AREAS:**

08-17-10)

RWZ-4Revised

**Markings: Two-Lane, Two-Way Facilities**

For all two-lane, two-way facilities, place all edge lines and other symbols within 30 calendar days after they have been obliterated by the resurfacing operation.

**Markings: All Facilities**

**The observation period for pavement markings on a specific map are subject to all requirements as specified in the Project Special Provision entitled "PAVEMENT MARKING LINES" contained elsewhere in the contract and begins with the satisfactory completion of all pavement markings required on that specific map.**

Any portion of stop bars that are obliterated at intersections of a multilane roadway and all its approaches shall be replaced by the end of each work day prior to opening the lane to traffic. Any portion of stop bars that are obliterated at 2-lane 2-way roadway intersections shall be replaced by the end of 5<sup>th</sup> calendar day.

Prior to opening the lane(s) to traffic, all pavement markings that are obliterated by milling should be replaced as specified in Subarticle 1205-3(D) Time Limitations for Replacement of the *Standard Specifications* or as stated herein.

Final pavement marking applications of paint shall be placed in 2 applications of 15 mils wet each. Each application of paint pavement marking lines will be measured and paid for as the actual number of linear feet of pavement marking lines that have been satisfactorily placed and accepted by the Engineer.

**Markers: All Facilities**

Install permanent pavement markers within 60 calendar days after completing the resurfacing on each map.





**ROADWAY STANDARD DRAWINGS FOR PAVEMENT MARKINGS AND MARKERS:**  
(7-18-06) RWZ-5

Use the following in conjunction with the *Standard Specifications*:

<b>Standard Pavement Markings</b>	<i>Roadway Standard Drawings:</i> 1205.01, 1205.02, 1205.03, 1205.04, 1205.05, 1205.06, 1205.07, 1205.08, 1205.09, 1205.10, 1205.11, 1205.12
<b>Raised Pavement Markers</b>	<i>Roadway Standard Drawings:</i> 1205.12, 1250.01, 1251.01
<b>Snowplowable Pavement Markers</b>	<i>Roadway Standard Drawings:</i> 1250.01, 1253.01
<b>Milled Rumble Strips</b>	<i>Roadway Standard Drawings:</i> 665.01

Date: 12-14-2010

**LEGEND**

-  PORTABLE SIGN. SIGNS MUST BE NCHRP-350 AND NCDOT APPROVED.
-  DIRECTION OF TRAFFIC FLOW
-  APPLICATION VEHICLE WITH LIGHT BAR
-  PROTECTION VEHICLE WITH TRUCK MOUNTED IMPACT ATTENUATOR (TMIA) AND LIGHT BAR (SEE ROADWAY DATA MUST BE NCHRP-350 TEST LEVEL 3 (60MPH) APPROVED.
-  FLASHING ARROW PANEL TYPE "B" (60"x30" MIN.), "CAUTION MODE"

**GENERAL NOTES**

- (1) THE FOLLOWING OPTIONS MAY BE USED FOR ADVANCE WARNING SIGNS:
  - A. TRUCK MOUNTED CHANGEABLE MESSAGE SIGN (CMS)
  - B. TRUCK MOUNTED ADVANCE WARNING SIGNS
  - C. GROUND MOUNTED ADVANCE WARNING SIGNS (MUST BE ATTACHED TO THE FRONT OF THE APPLICATION VEHICLE)
  - D. GROUND MOUNTED ADVANCE WARNING SIGNS (MUST BE ATTACHED TO THE FRONT OF THE APPLICATION VEHICLE)
- (2) ALL ADVANCE WARNING SIGNS MUST BE 48" X 48" WITH FLUORESCENT ORANGE TYPE VII, VIII OR IX SHEETING. IF SPACE LIMITATIONS ON SHOULDER PROHIBIT A 48" X 48" SIGN, A SMALLER SIGN CAN BE USED WITH APPROVAL FROM ENGINEER.
- (3) SIGNS ON VEHICLES SHOULD BE MOUNTED AT A MINIMUM OF ONE (1) FOOT FROM THE GROUND AND SHOULD NOT BLOCK THE MOTORIST'S SIGHT OF THE FLASHING ARROW PANEL AND/OR LIGHTBAR.
- (4) GROUND MOUNTED ADVANCED WARNING SIGNS SHOULD BE MOUNTED AT A MINIMUM OF ONE (1) FOOT FROM THE GROUND TO BOTTOM OF SIGN.
- (5) SIGN SPACING SHOULD BE ADJUSTED FOR HORIZONTAL AND VERTICAL CURVES, ETC. TO IMPROVE SIGHT DISTANCES.
- (6) ADDITIONAL VEHICLES SHOULD BE USED IN WORK CARAVAN TO FACILITATE DRYING OF PAVEMENT MARKING MATERIAL (TMIA'S ARE OPTIONAL ON THESE ADDITIONAL VEHICLES). HOWEVER, THE FIRST VEHICLE MOTORISTS SEE IN THE TRAVEL LANE SHALL HAVE A TMIA.
- (7) ADJUST DISTANCE AS NEEDED TO PREVENT MOTORISTS FROM ENTERING SPACE BETWEEN THE APPLICATION AND PROTECTION VEHICLE. DISTANCE CAN BE LENGTHENED TO ACCOMMODATE SIGHT DISTANCE NEEDS.
- (8) ROUND UP MILEAGE TO NEXT WHOLE MILE. WORK ZONE SHOULD NOT EXCEED FIVE (5) MILES IN LENGTH.
- (9) RADIO COMMUNICATION BETWEEN VEHICLES IS REQUIRED.
- (10) USE OF A LIGHT BAR ON ALL VEHICLES IS PREFERRED, BUT A ROTATING BEACON MAY BE USED INSTEAD.
- (11) IF WORK IS PERFORMED AT NIGHT, THE WORK AREA MUST BE ILLUMINATED WITH MACHINE AND/OR TOWER LIGHTS AS APPROVED BY THE ENGINEER.
- (12) ALL TRAFFIC CONTROL DEVICES WILL BE CONSIDERED INCIDENTAL TO THE PAY ITEMS FOR PAVEMENT MARKING AND MARKERS.
- (13) INFORMATIONAL SIGNS SHOULD BE ACTIVITY SPECIFIC, I.E. "PAINT CREW IN ROAD". SIGNS MAY BE RECTANGULAR OR DIAMOND SHAPE. SIGN SIZE SHOULD BE BASED ON THE MOTORIST'S ABILITY TO RECOGNIZE SIGN WHEN TRAVELING FIVE (5) MILES ABOVE POSTED SPEED LIMIT.
- (14) IF A LEAD VEHICLE IS ADDED TO OPERATION IT SHOULD HAVE THE SAME ADVANCE WARNING SIGNS AS THE APPLICATION VEHICLE SHOWN BELOW.

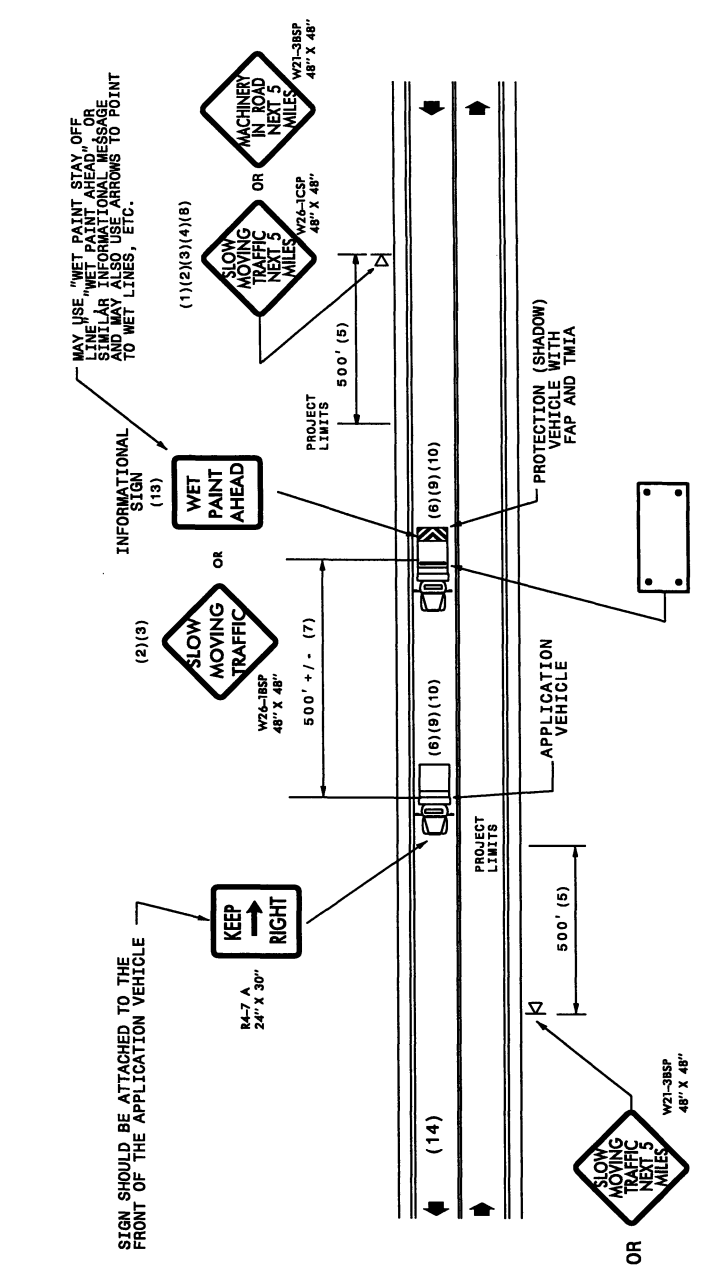
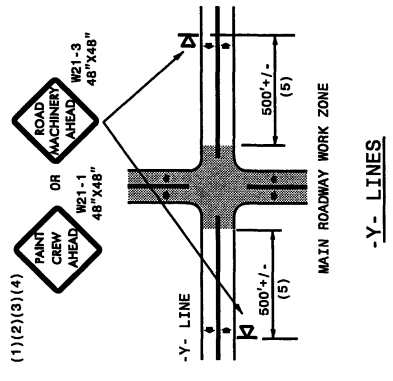

**MOVING OPERATION CARAVAN**  
 (OPERATIONS TRAVELING 3 MPH OR FASTER)  
 PLACING PAVEMENT MARKING OR MARKERS  
 ON TWO-LANE TWO-WAY ROADWAYS

**DRAWING NUMBER 6**  
 IMPLEMENTATION DATE: 07/01/97  
 REVISED: 11/03/04



**GENERAL NOTES**

- (1) THE FOLLOWING OPTIONS MAY BE USED FOR ADVANCE WARNING SIGNS:
  - A. TRUCK MOUNTED CHANGEBLE MESSAGE SIGN (CMS)
  - B. GROUND MOUNTED ADVANCE WARNING SIGNS (CMS)
  - C. GROUND MOUNTED ADVANCE WARNING SIGNS (MUST CIRCLE TO PICK UP SIGNS)
  - D. GROUND MOUNTED CHANGEBLE MESSAGE SIGN (CMS) (MUST USE CIRCLE TO PICK UP SIGNS)
- (2) ALL ADVANCE WARNING SIGNS MUST BE 48" X 48" WITH LETTERS 1 1/2" HIGH. USE WHITE ON BLACK SHEETING. THE SPACING BETWEEN SIGNS ON SHOULDER SHOULD BE 48" X 48" SIGN, A SMALLER SIGN CAN BE USED WITH APPROVAL FROM ENGINEER.
- (3) SIGNS ON VEHICLES SHOULD BE MOUNTED A MINIMUM OF ONE (1) FOOT FROM THE GROUND AND SHOULD NOT BLOCK THE MOTORIST'S SIGHT OF THE FLASHING ARROW PANEL AND/OR LIGHTBAR.
- (4) GROUND MOUNTED ADVANCED WARNING SIGNS SHOULD BE MOUNTED A MINIMUM OF FIVE (5) FEET FROM THE GROUND TO BOTTOM OF SIGN.
- (5) SIGN SPACING SHOULD BE ADJUSTED FOR HORIZONTAL AND VERTICAL CURVES, ETC. TO IMPROVE SIGHT DISTANCES.
- (6) ADDITIONAL VEHICLES SHOULD BE USED IN WORK CARAVAN TO FACILITATE DRYING OF PAVEMENT MARKING MATERIAL (TMIA'S ARE OPTIONAL ON THESE ADDITIONAL VEHICLES). HOWEVER, THE FIRST VEHICLE MOTORIST SEE IN THE TRAVEL LANE SHALL HAVE A TMIA.
- (7) ADJUST DISTANCE AS NEEDED TO PREVENT MOTORISTS FROM ENTERING SPACE BETWEEN THE APPLICATION AND PROTECTION VEHICLE. DISTANCE CAN BE LENGTHENED TO ACCOMMODATE SIGHT DISTANCE NEEDS.
  - (8) ROUND UP MILEAGE TO NEXT WHOLE MILE. WORK ZONE SHOULD NOT EXCEED FIVE (5) MILES IN LENGTH.
  - (9) RADIO COMMUNICATION BETWEEN VEHICLES IS REQUIRED.
  - (10) USE OF A LIGHT BAR ON ALL VEHICLES IS PREFERRED, BUT A ROTATING BEACON MAY BE USED INSTEAD.
  - (11) IF WORK IS PERFORMED AT NIGHT, THE WORK AREA MUST BE ILLUMINATED WITH MACHINE AND/OR TOWER LIGHTS AS APPROVED BY THE ENGINEER.
  - (12) ALL TRAFFIC CONTROL DEVICES WILL BE CONSIDERED INCIDENTAL TO THE PAY ITEMS FOR PAVEMENT MARKING AND MARKERS.

**LEGEND**

- K
  - ➔
  - 
  - 
  - 
  - 
  - 
  -
- PORTABLE SIGN. SIGNS MUST BE NCHRP-350 AND NODOT APPROVED.  
DIRECTION OF TRAFFIC FLOW
- APPLICATION VEHICLE WITH LIGHT BAR
- PROTECTION VEHICLE WITH TRUCK MOUNTED SIGN (SEE ROADWAY (TMIA) STANDARD NO. 1165.01). TMIA MUST BE NCHRP-350 TEST LEVEL 3 (60+MPH) APPROVED.
- ADVANCE WARNING VEHICLE WITH SIGN (CMS) AND LIGHT BAR. MESSAGE SIGN LETTER HEIGHT SHOULD BE A MINIMUM OF 10 INCHES.
- FLASHING ARROW PANEL, FLASHING ARROW PANEL WITH APPROPRIATE DIRECTION INDICATED
- CHANGEBLE MESSAGE SIGN

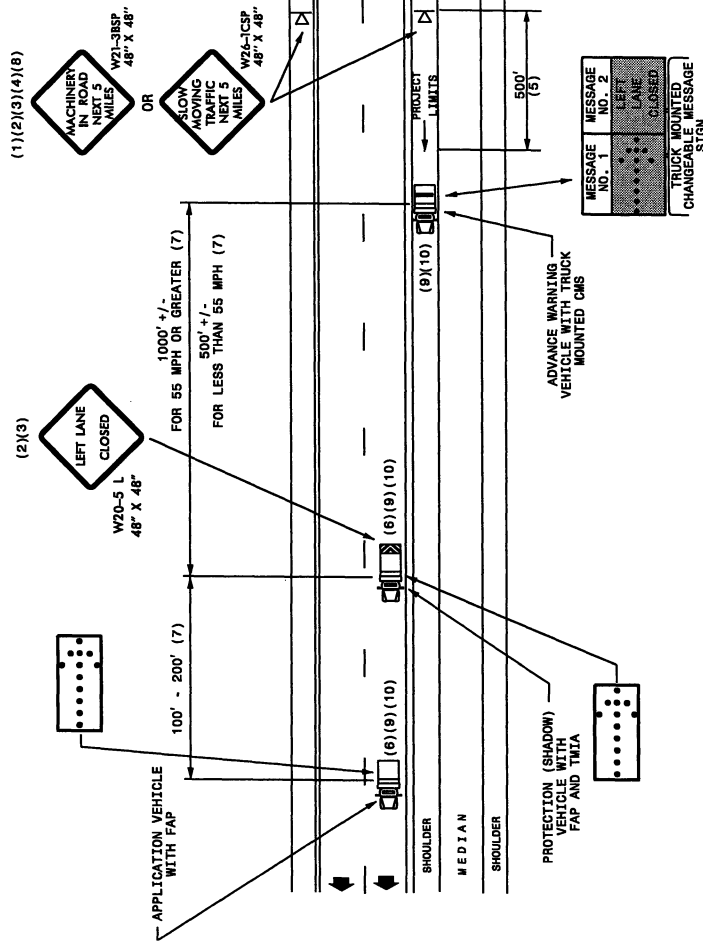
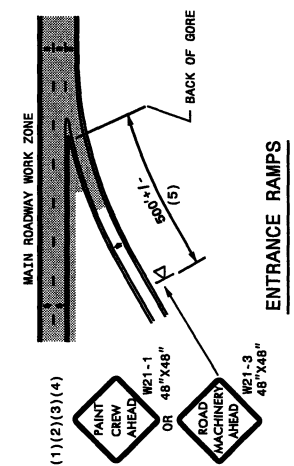
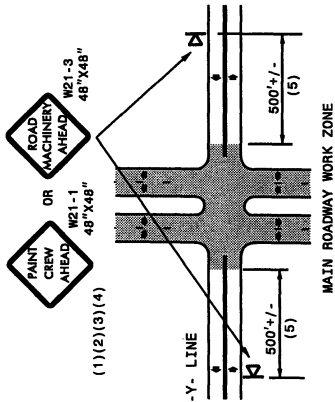

**MOVING OPERATION CARAVAN**  
(OPERATIONS TRAVELING 3 MPH OR FASTER)  
PLACING PAVEMENT MARKING OR MARKERS  
ON NON-INTERSTATE MULTILANE DIVIDED ROADWAYS

**DRAWING NUMBER 7**  
IMPLEMENTATION DATE: 07/01/97  
REVISED: 11/03/04