

Approximate quantities only. Unclassified excavation, borrow excavation, fine grading, clearing and grubbing, and removal of existing pavement will be paid for at the lump sum price for "Grading".

**STATE OF NORTH CAROLINA
DIVISION OF HIGHWAYS
CROSS-SECTION SUMMARY**

PROJ. REFERENCE NO.	SHEET NO.
B-4008	X-1

NOTE: EMBANKMENT COLUMN DOES NOT INCLUDE BACKFILL FOR UNDERCUT

Station -L-	Uncl. Exc. (cu. yd.)	Embt (cu. yd.)			
12+75.00	0	0			
13+00.00	0	1			
13+25.00	1	3			
13+50.00	1	18			
13+75.00	1	22			
14+00.00	12	7			
14+25.00	11	35			
14+50.00	0	46			
14+75.00	0	39			
15+00.00	0	83			
15+25.00	0	147			
15+34.00	0	69			
Structure Excavation					
Station -L-	Uncl. Exc. (cu. yd.)	Embt (cu. yd.)			
15+34.00	0	0			
15+43.00	40	0			
15+50.00	52	0			
15+63.00	40	0			
16+26.00	0	0			
16+32.00	27	0			
16+50.00	154	0			
16+54.00	37	0			
16+64.00	47	0			
Station -L-	Uncl. Exc. (cu. yd.)	Embt (cu. yd.)	Rock Excavation		
			Station (ALONG ROCK EXCAVATION)	Station (ALONG ALIGNMENTS)	Uncl. Exc. (cu. yd.)
16+64.00	0	0			
16+75.00	0	105			
17+00.00	0	202	0+00.00	-L- 17+18 (25' RT)±	0
17+25.00	0	145	0+08.10	-L- 17+25 (26' RT)±	1
17+50.00	0	83	0+16.10	-L- 17+32 (29' RT)±	6
17+75.00	0	35	0+24.10	-L- 17+37 (33' RT)±	10
18+00.00	10	28	0+32.00	-L- 17+42 (39' RT)±	14
18+25.00	13	36	0+39.70	-Y- 10+39 (37' RT)±	14
18+50.00	10	23	0+48.10	-Y- 10+45 (31' RT)±	15
18+75.00	32	9	0+56.80	-Y- 10+52 (26' RT)±	10
19+00.00	31	4	0+65.00	-Y- 17+61 (23' RT)±	2
19+25.00	5	1			
19+50.00	0	0			

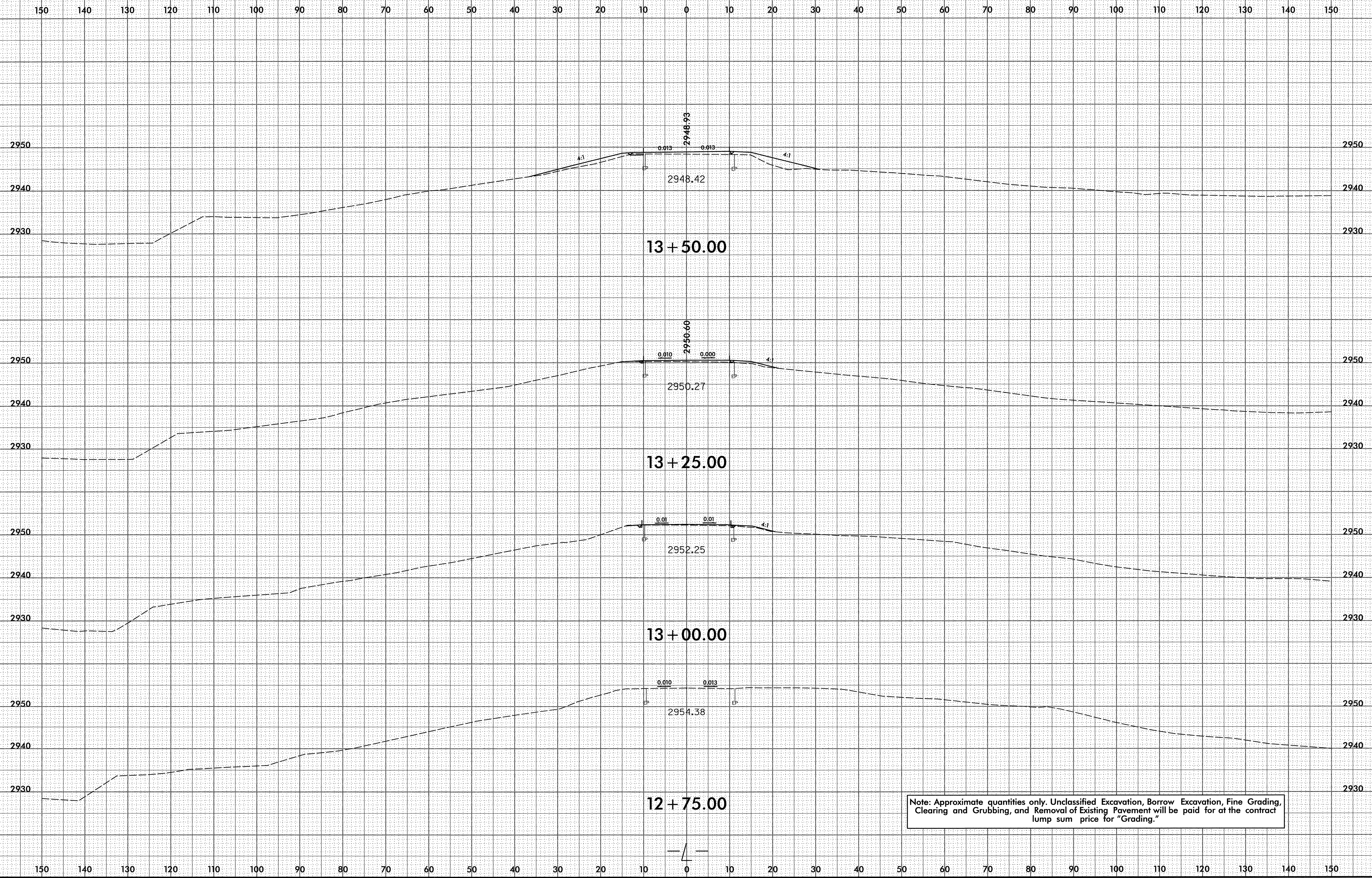

Note: Approximate quantities only. Unclassified Excavation, Borrow Excavation, Fine Grading, Clearing and Grubbing, and Removal of Existing Pavement will be paid for at the contract lump sum price for "Grading."

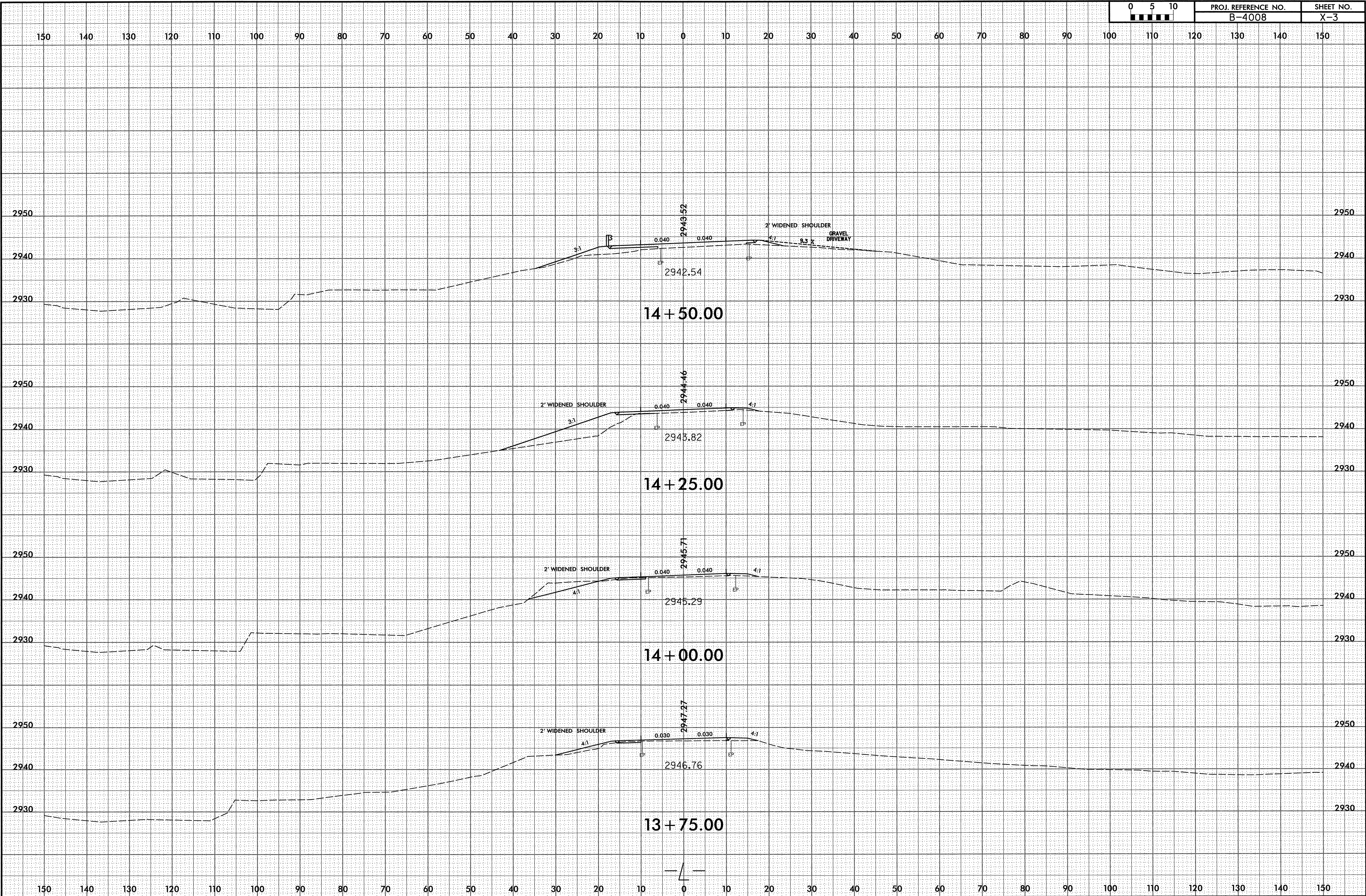

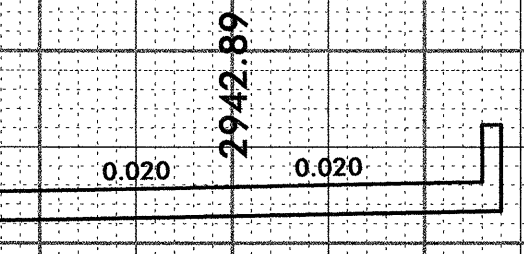
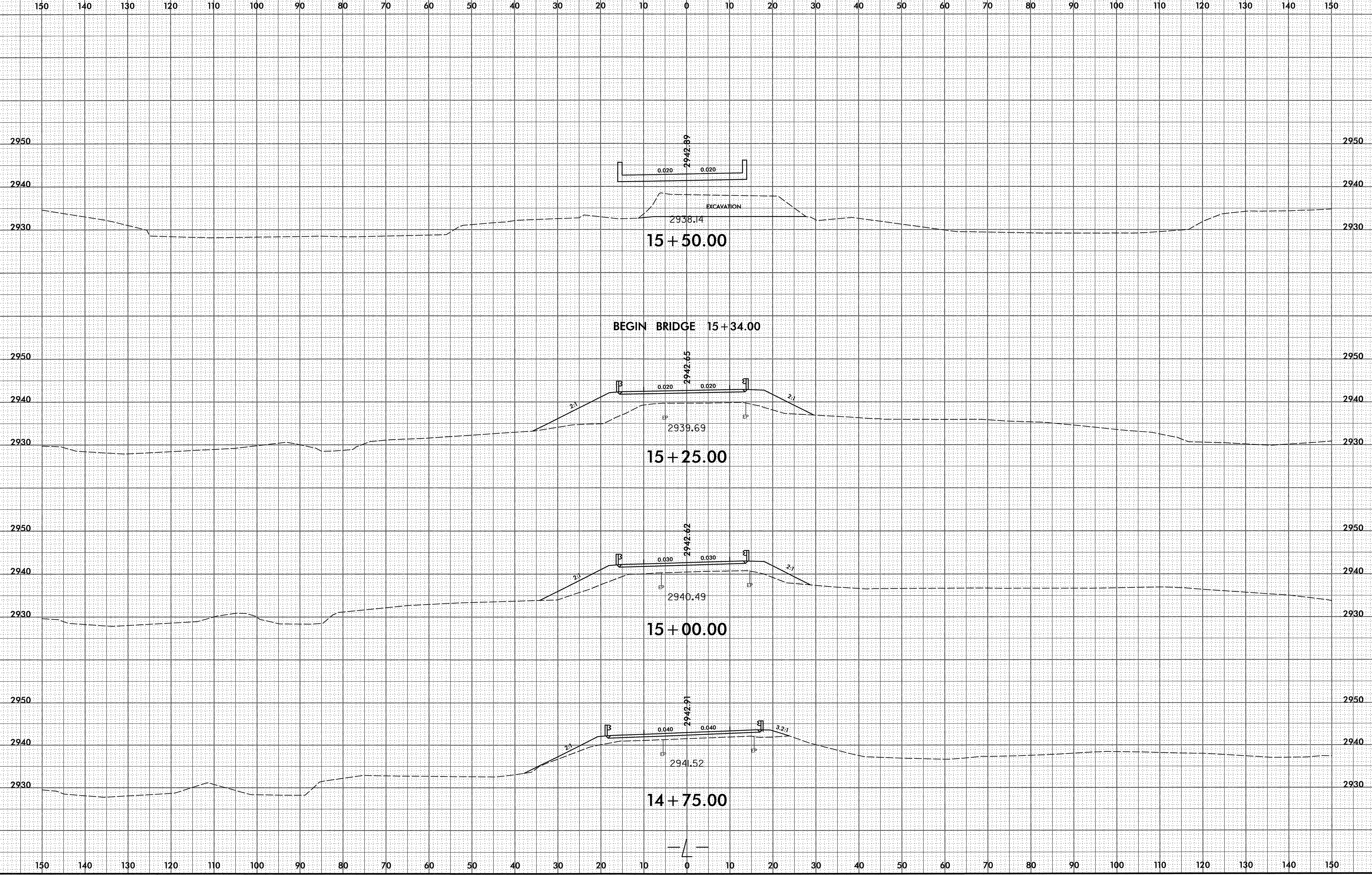

EXCAVATION
2938.14
15 + 50.00

BEGIN BRIDGE 15 + 34.00

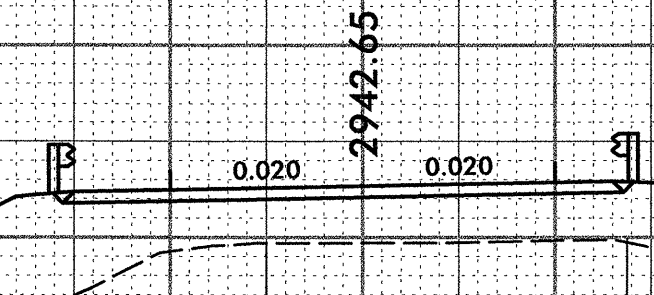

2939.69
15 + 25.00

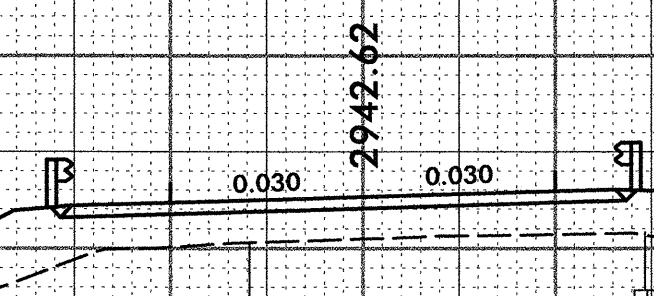

2940.49
15 + 00.00

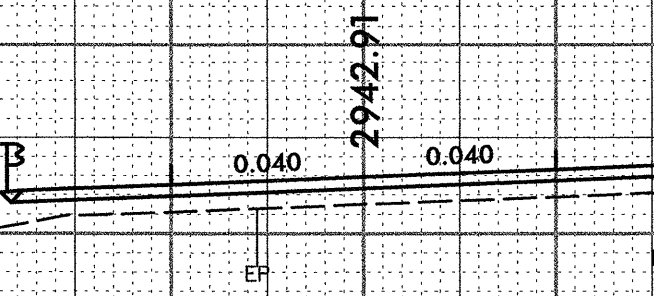

2941.52
14 + 75.00

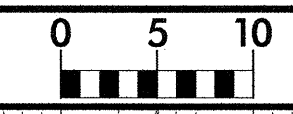

150 140 130 120 110 100 90 80 70 60 50 40 30 20 10 0 10 20 30 40 50 60 70 80 90 100 110 120 130 140 150

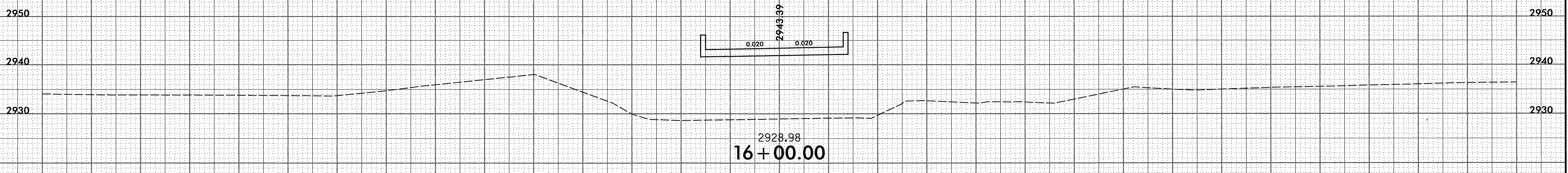
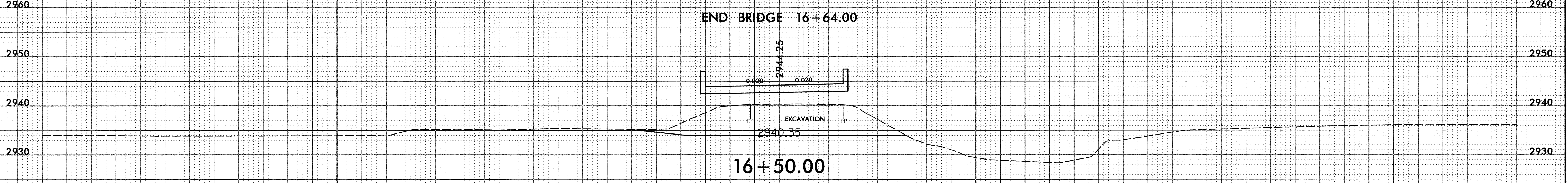
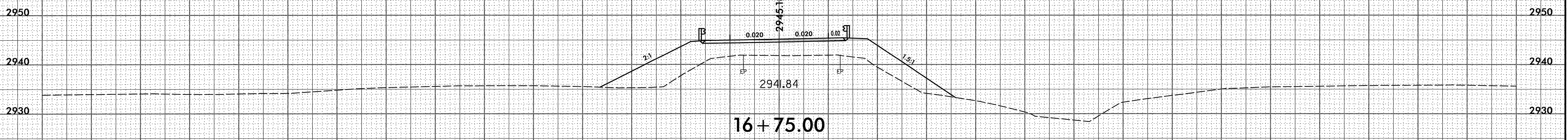
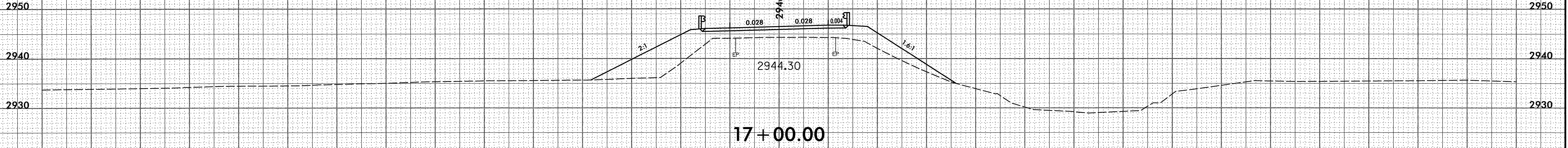

150 140 130 120 110 100 90 80 70 60 50 40 30 20 10 0 10 20 30 40 50 60 70 80 90 100 110 120 130 140 150

