



PROJECT REFERENCE NO. R-2554BA	SHEET NO. RF-1
R / W SHEET NO.	
ROADWAY DESIGN ENGINEER	HYDRAULICS ENGINEER

PLANTING DETAILS

SEEDLING / LINER BAREROOT PLANTING DETAIL

HEALING IN

1. Locate a healing-in site in a shady, well protected area.
2. Excavate a flat bottom trench 300mm deep and provide drainage.

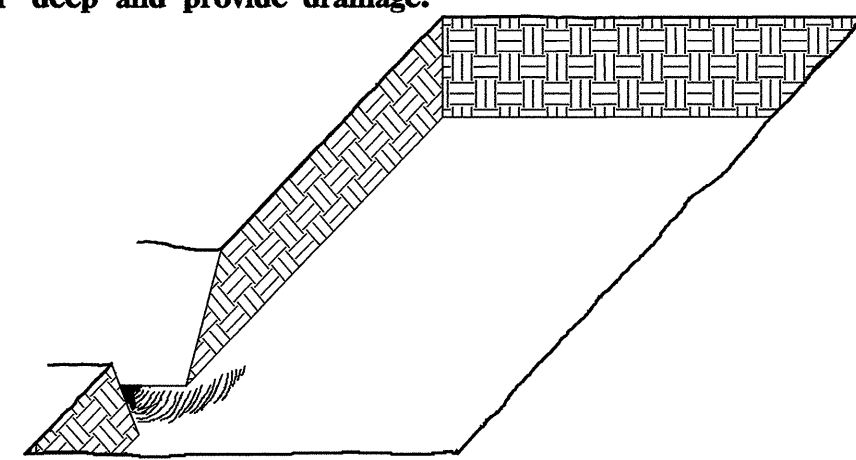

3. Backfill the trench with 50mm well rotted sawdust. Place a 50mm layer of well rotted sawdust at a sloping angle at one end of the trench.

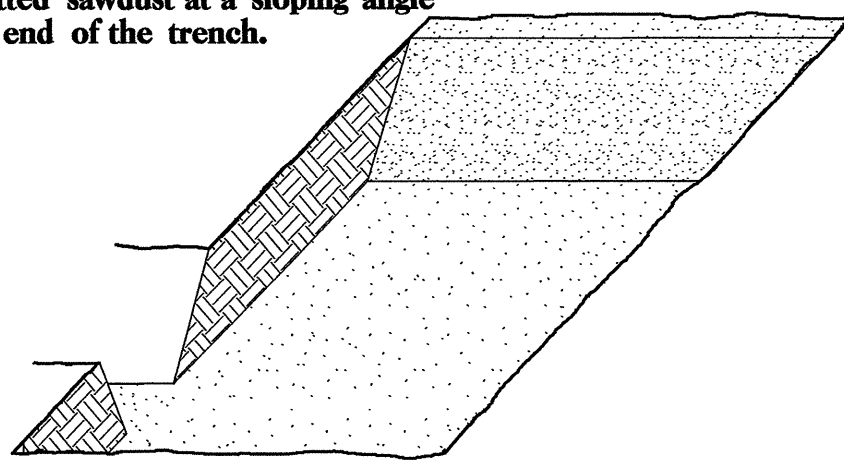

4. Place a single layer of plants against the sloping end so that the root collar is at ground level.

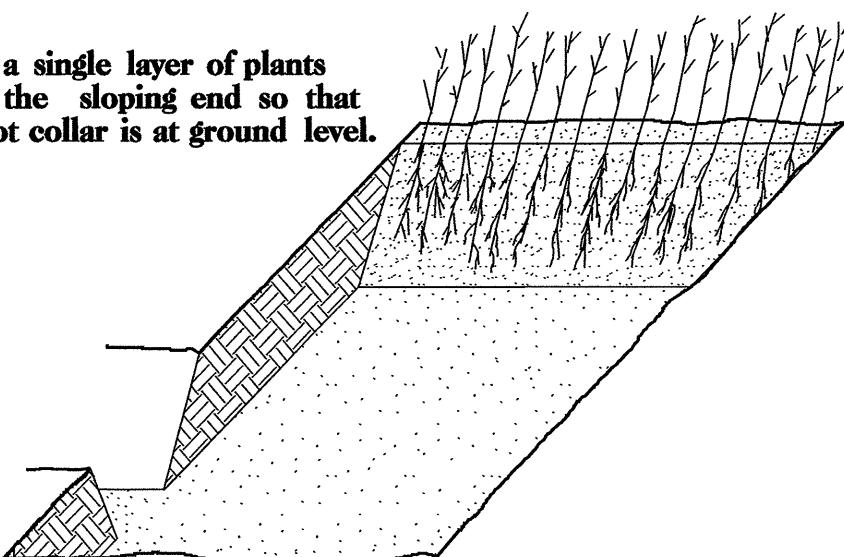

5. Place a 50mm layer of well rotted sawdust over the roots maintaining a sloping angle.

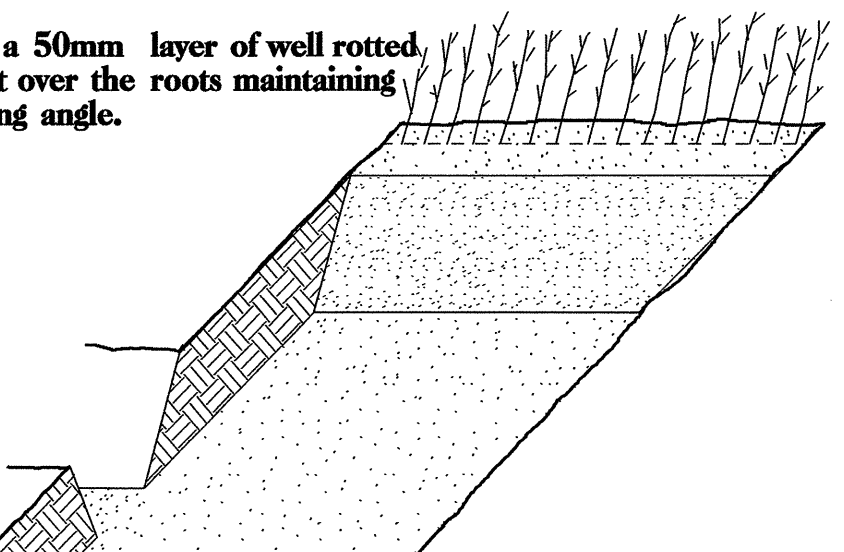

6. Repeat layers of plants and sawdust as necessary and water thoroughly.

DIBBLE PLANTING METHOD USING THE KBC PLANTING BAR

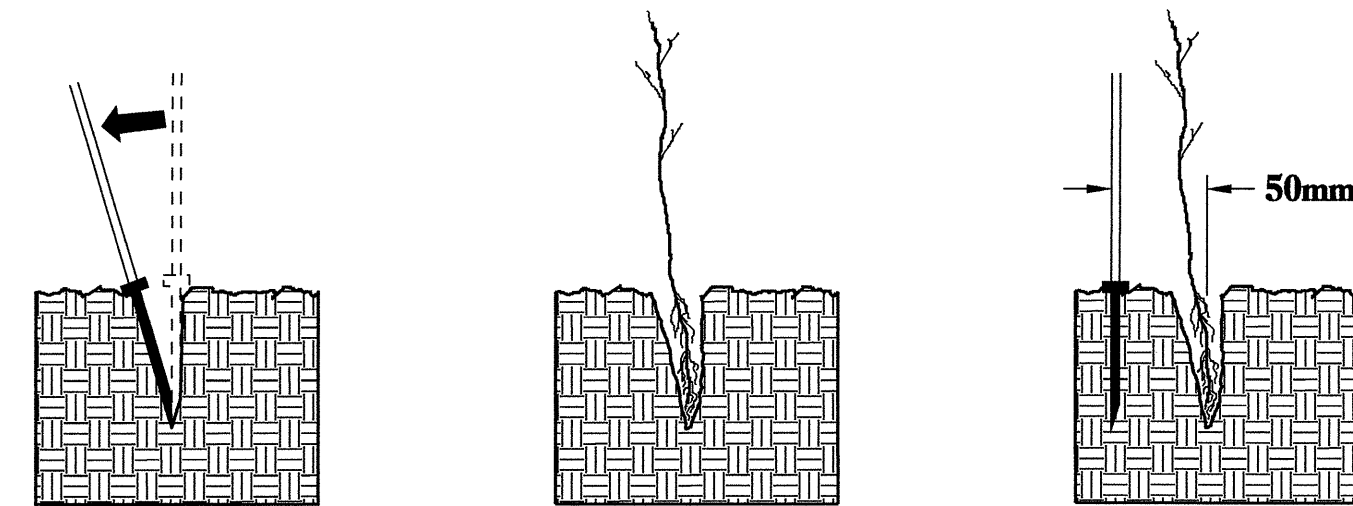

1. Insert planting bar as shown and pull handle toward planter.

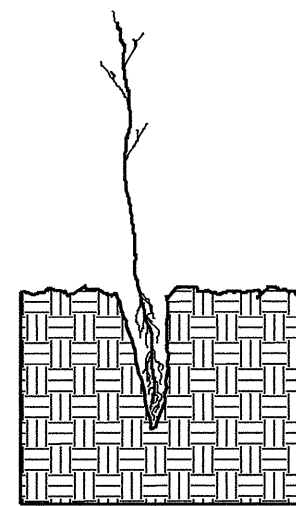

2. Remove planting bar and place seedling at correct depth.

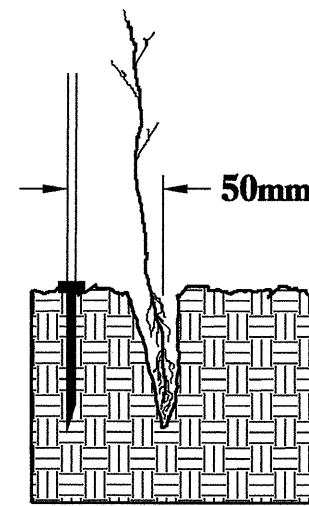

3. Insert planting bar 50mm toward planter from seedling.

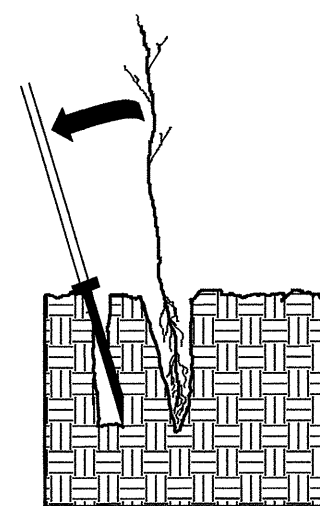

4. Pull handle of bar toward planter, firming soil at bottom.

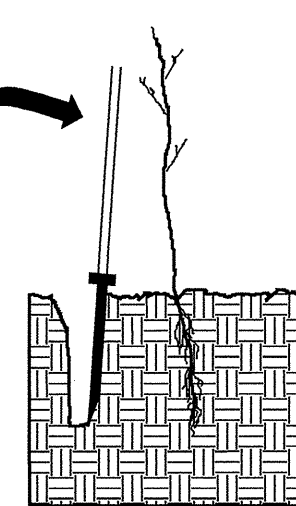

5. Push handle forward firming soil at top.

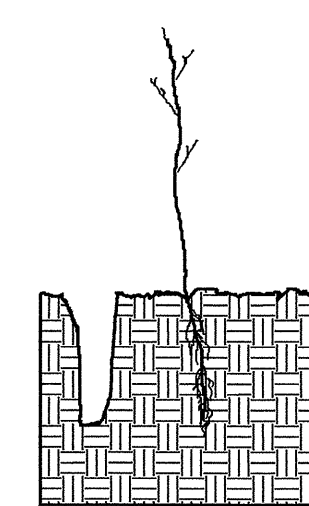

6. Leave compaction hole open. Water thoroughly.

PLANTING NOTES:

PLANTING BAG

During planting, seedlings shall be kept in a moist canvas bag or similar container to prevent the root systems from drying.



KBC PLANTING BAR

Planting bar shall have a blade with a triangular cross section, and shall be 300mm long, 100mm wide and 25mm thick at center.

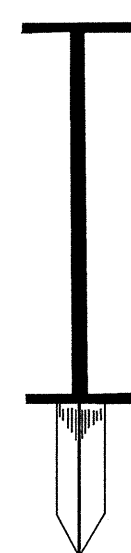

ROOT PRUNING

All seedlings shall be root pruned, if necessary, so that no roots extend more than 250mm below the root collar.

REFORESTATION

- TREE REFORESTATION SHALL BE PLANTED 1.8m TO 3.0m ON CENTER, RANDOM SPACING, AVERAGING 2.4m ON CENTER, APPROXIMATELY 1680 PLANTS PER HECTARE.

REFORESTATION

MIXTURE, TYPE, SIZE, AND FURNISH SHALL CONFORM TO THE FOLLOWING:

25% BETULA NIGRA	RIVER BIRCH	305mm - 457mm BR
25% PLATANUS OCCIDENTALIS	SYCAMORE	305mm - 457mm BR
25% LIRIODENDRON TULIPIFERA	TULIP POPLAR	305mm - 457mm BR
25% JUGLANS NIGRA	BLACK WALNUT	305mm - 457mm BR

REFORESTATION DETAIL SHEET

N.C.D.O.T. - ROADSIDE ENVIRONMENTAL UNIT



PROJECT REFERENCE NO. R-2554BA	SHEET NO. RF-3
R/W SHEET NO.	
ROADWAY DESIGN ENGINEER	HYDRAULICS ENGINEER

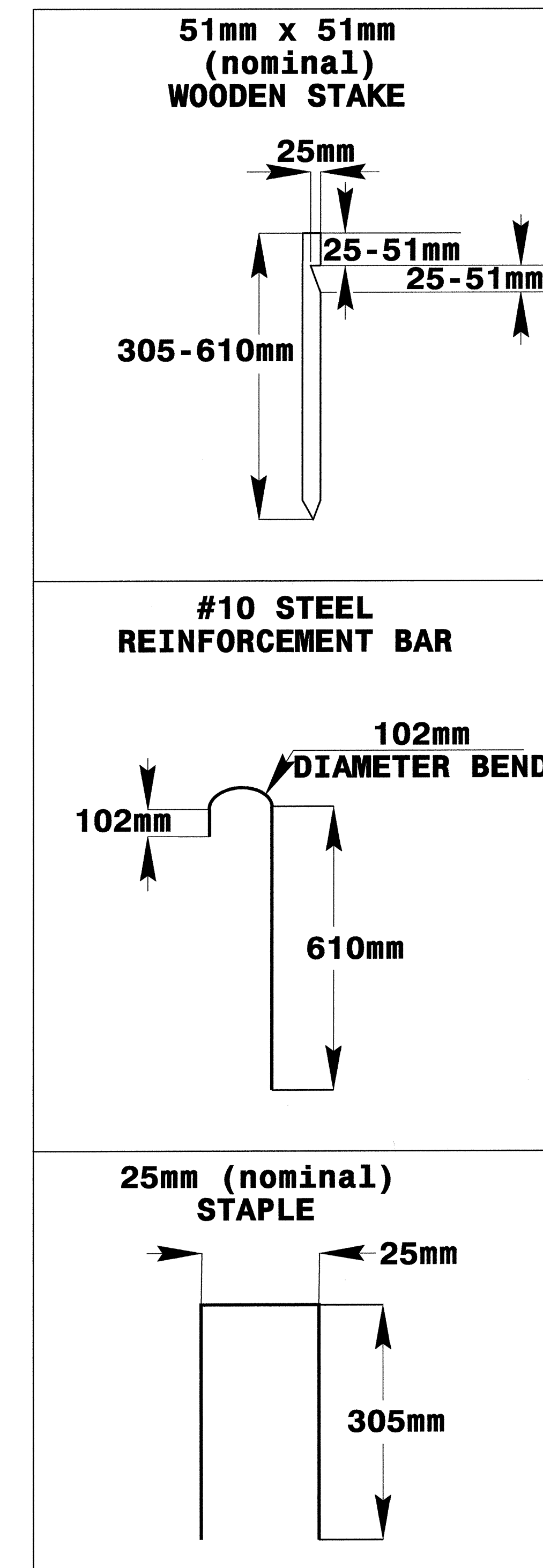
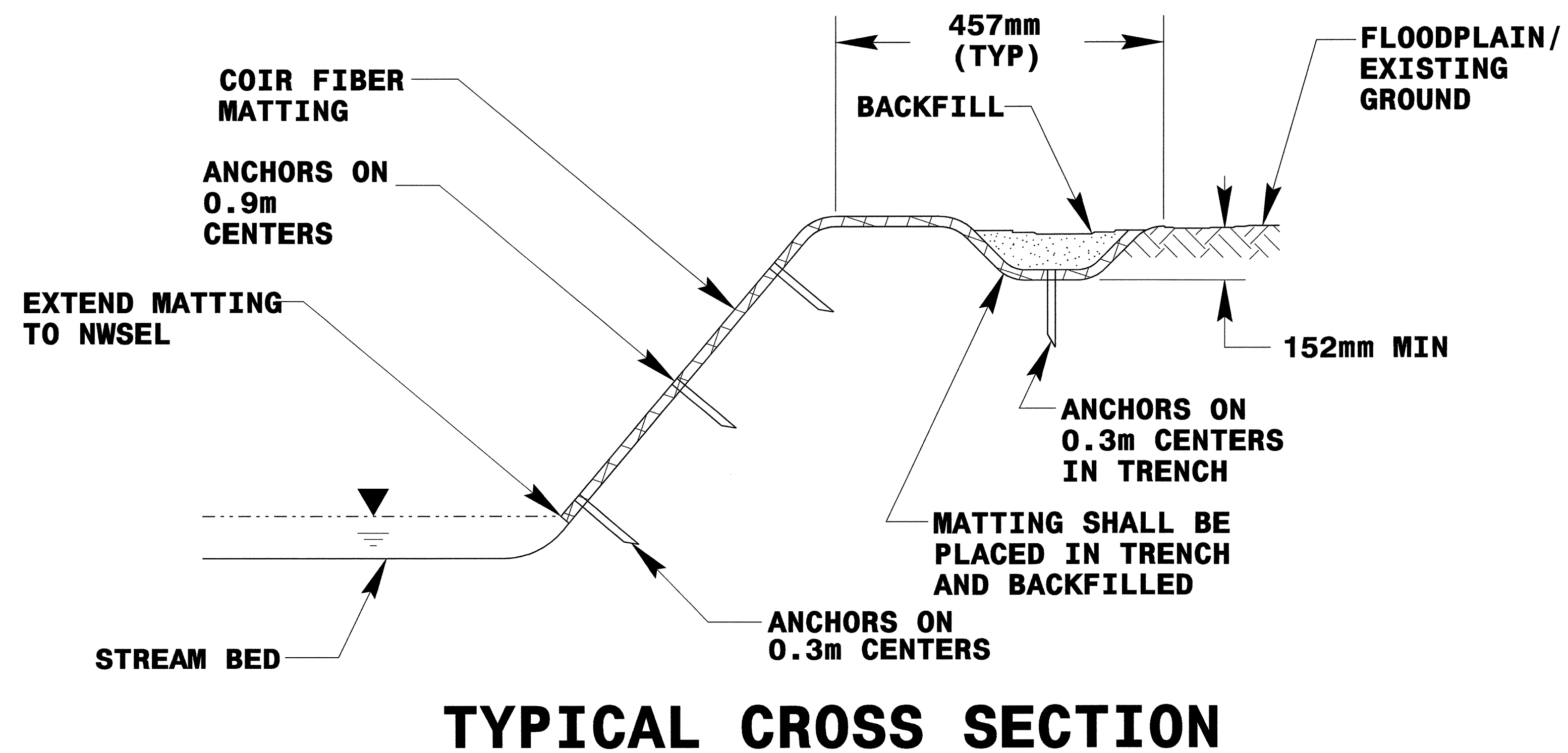
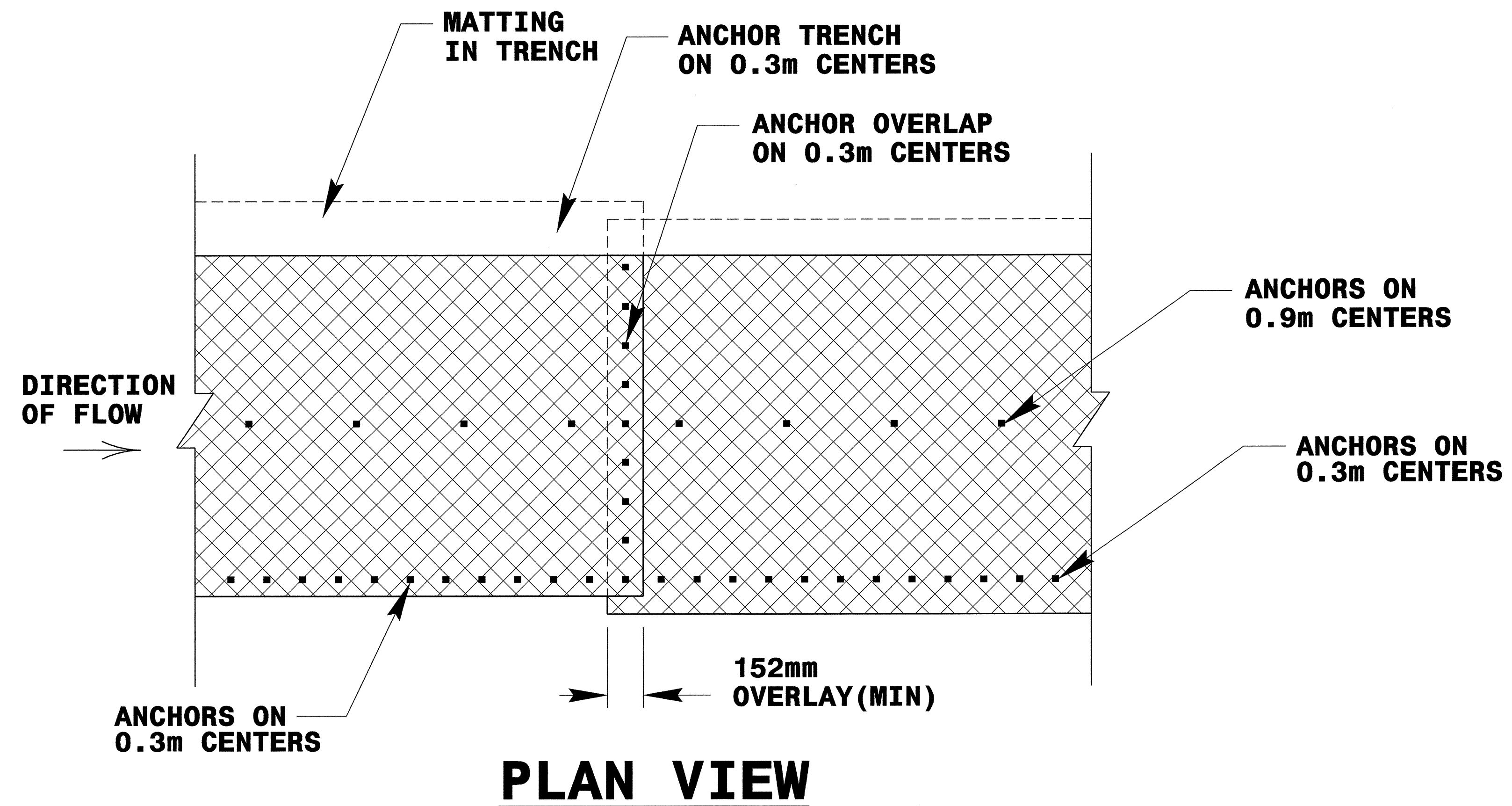

COIR FIBER MATTING DETAIL

NOT TO SCALE

STREAMBANK REFORESTATION DETAIL SHEET 2 OF 2

N.C.D.O.T. - ROADSIDE ENVIRONMENTAL UNIT