

## PLANTING DETAILS

### SEEDLING / LINER BAREROOT PLANTING DETAIL

#### HEALING IN

1. Locate a healing-in site in a shady, well protected area.
2. Excavate a flat bottom trench 12 inches deep and provide drainage.

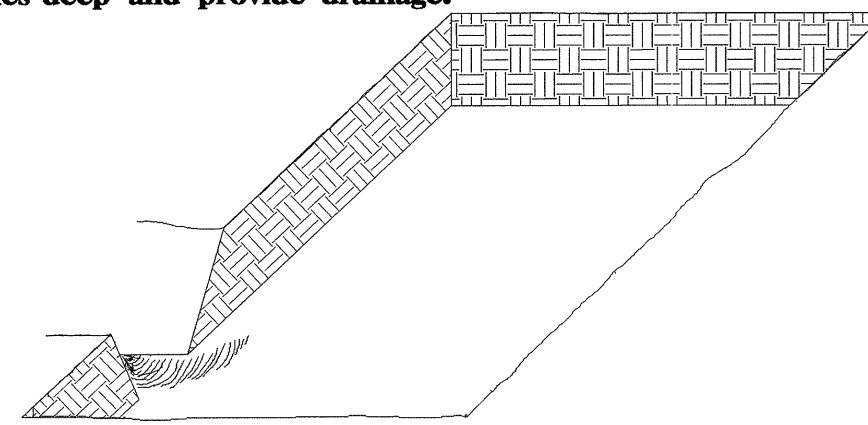

3. Backfill the trench with 2 inches well rotted sawdust. Place a 2 inch layer of well rotted sawdust at a sloping angle at one end of the trench.

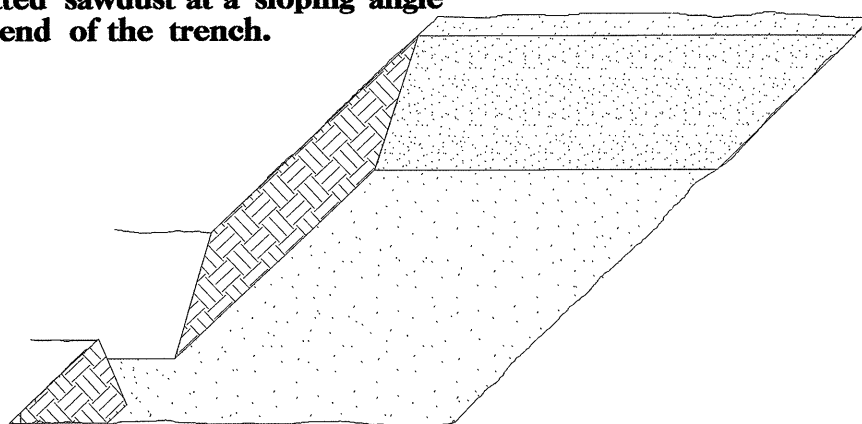

4. Place a single layer of plants against the sloping end so that the root collar is at ground level.

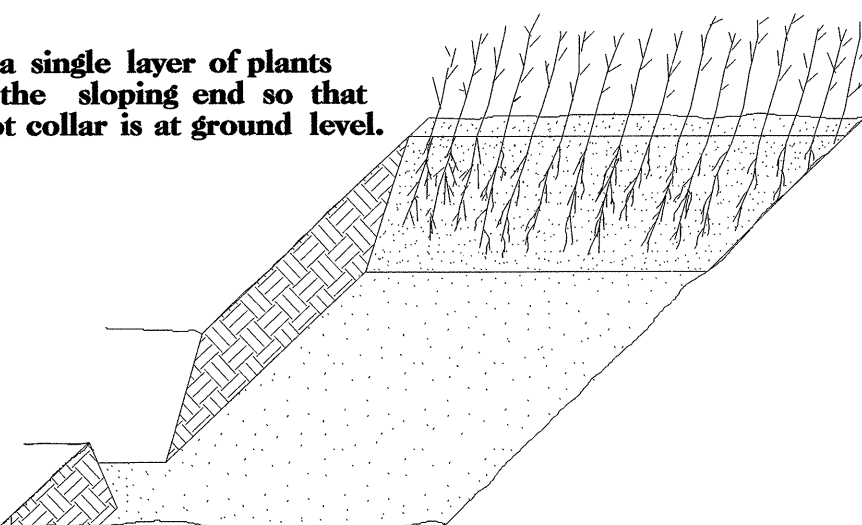

5. Place a 2 inch layer of well rotted sawdust over the roots maintaining a sloping angle.

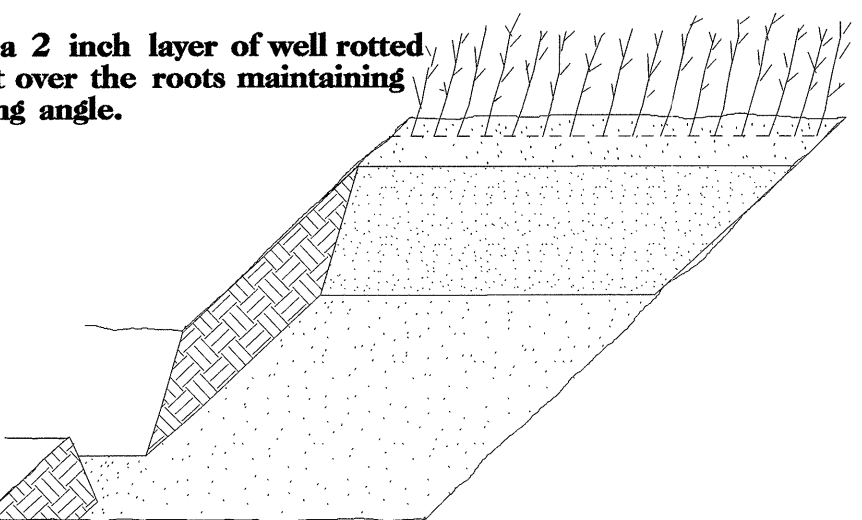

6. Repeat layers of plants and sawdust as necessary and water thoroughly.

#### DIBBLE PLANTING METHOD USING THE KBC PLANTING BAR

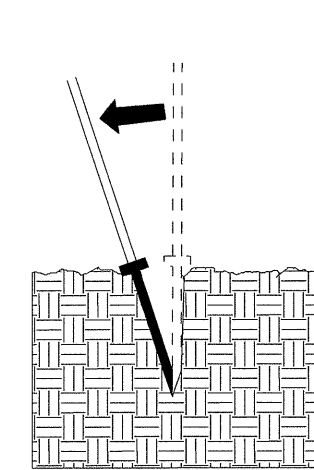

1. Insert planting bar as shown and pull handle toward planter.

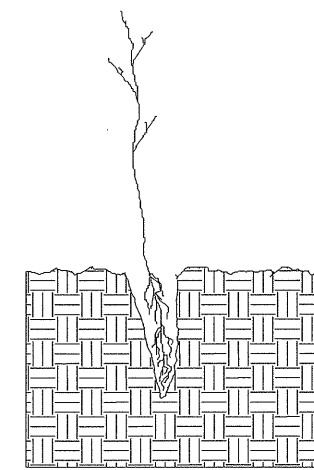

2. Remove planting bar and place seedling at correct depth.

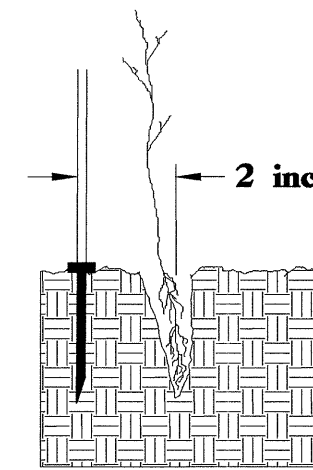

3. Insert planting bar 2 inches toward planter from seedling.

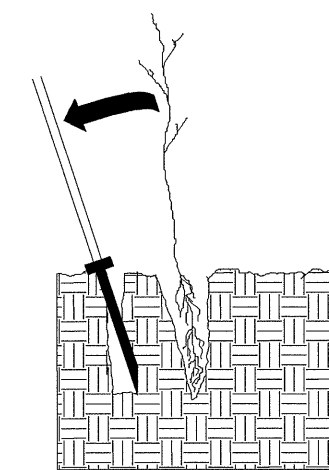

4. Pull handle of bar toward planter, firming soil at bottom.

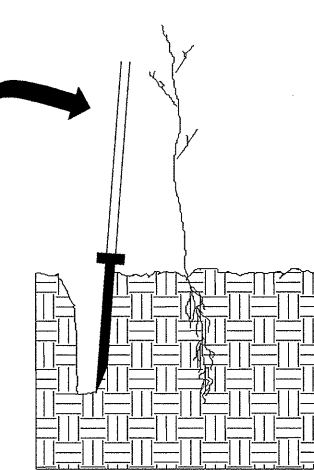

5. Push handle forward firming soil at top.

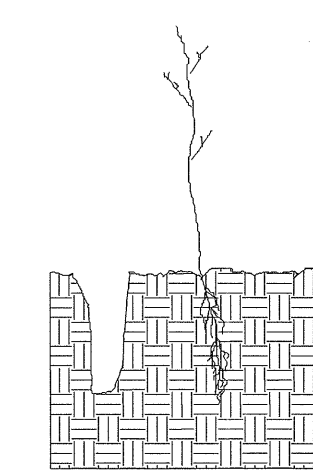

6. Leave compaction hole open. Water thoroughly.

#### PLANTING NOTES:

**PLANTING BAG**  
During planting, seedlings shall be kept in a moist canvas bag or similar container to prevent the root systems from drying.



**KBC PLANTING BAR**  
Planting bar shall have a blade with a triangular cross section, and shall be 12 inches long, 4 inches wide and 1 inch thick at center.

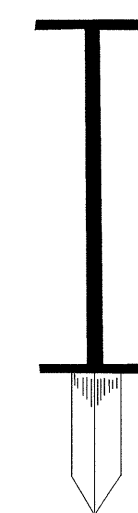

**ROOT PRUNING**  
All seedlings shall be root pruned, if necessary, so that no roots extend more than 10 inches below the root collar.

## REFORESTATION

- TREE REFORESTATION SHALL BE PLANTED 6 FT. TO 10 FT. ON CENTER, RANDOM SPACING, AVERAGING 8 FT. ON CENTER, APPROXIMATELY 680 PLANTS PER ACRE.

#### REFORESTATION

MIXTURE, TYPE, SIZE, AND FURNISH SHALL CONFORM TO THE FOLLOWING:

35% PRUNUS SEROTINA	BLACK CHERRY	12 in - 18 in BR
35% LIRIODENDRON TULIPIFERA	TULIP POPLAR	12 in - 18 in BR
30% ALNUS SERRULATA	TAG ALDER	12 in - 18 in BR

## REFORESTATION DETAIL SHEET

N.C.D.O.T. - ROADSIDE ENVIRONMENTAL UNIT