

PROJECT SPECIAL PROVISIONS**Traffic****WORK ZONE SIGNING:**

09-16-03

1- DESCRIPTION.

Install and maintain signing in accordance with Divisions 11 and 12 of the North Carolina Department of Transportation January 2002 Standard Specifications for Roads and Structures, the North Carolina Department of Transportation January 2002 Highway Design Branch Roadway Standard Drawings and the following provisions:

Furnish, install, maintain, and remove advance warning work zone signs and any required lane closure signing.

Furnish, install, and maintain general work zone warning signs for resurfacing and/or milling such as "Rough Road" (W8-8 at 48" X 48") (for milling only), "Uneven Pavement" (W8-15 at 48" X 48"), "Low Shoulder" (W8-9 at 48" X 48"), "Low / Soft Shoulder" (W8-9B at 48" X 48"), "Unmarked Pavement Ahead" (W16-10 at 48" X 48"), and "Do Not Pass"(R4-1 at 24" X 30". When construction is completed in any given area of the project, relocate signs to the next work site, as directed by the Engineer. Remove these signs at the completion of the project.

All work zone signs may be portable.

2- CONSTRUCTION METHODS.**(A) General:**

Install all warning work zone signs before beginning work on a particular map. If signs are installed three days prior to the beginning of work on a particular map, cover the signs until the work begins. Install each work zone warning sign separately and not on the same post(s) with any other sign except where an advisory speed plate or directional arrow is used.

(B) Advance warning work zone signs:

Install advance warning work zone signs (see attached Detail(s) and North Carolina Department of Transportation January 2002 Highway Design Branch Roadway Standard Drawings Nos. 1101.02 and 1110.01) prior to beginning of work and remove upon final completion of the project. If there is a period of construction inactivity longer than two weeks, remove or cover advance warning work zone signs. Uncover advance warning work zone signs no more than 3 days before work resumes. All other operations could be suspended upon failure to comply with the above requirements. Such suspended operations would not be resumed until the above requirements are fulfilled.

(C) Lane closure work zone signs:

Install any required lane closure signing needed during the life of the project (see North Carolina Department of Transportation January 2002 Highway Design Branch Roadway Standard Drawings Nos. 1101.02, 1101.11 and 1110.02).

(D) General work zone warning signs:

Install general work zone warning signs for resurfacing and/or milling such as "Rough Road" (W8-8 at 48" X 48") (for milling only), "Uneven Pavement" (W8-15 at 48" X 48"), "Low Shoulder" (W8-9 at 48" X 48") and "Low / Soft Shoulder" (W8-9B at 48" X 48") at 1 mile intervals starting at a minimum of 500 feet in advance of the condition for both directions of travel (undivided roadways only) and at any other points determined by the Engineer.

Install the "Low Shoulder" (W8-9 at 48" X 48") or "Low / Soft Shoulder" (W8-9B at 48" X 48") signs prior to any resurfacing in an area where shoulder construction will be performed. Install general work zone warning signs such as "Unmarked Pavement Ahead" (W16-10 at 48" X 48") and "Do Not Pass"(R4-1 at 24" X 30") alternately at 1/2 mile intervals starting at a minimum of 500 feet in advance of the condition for both directions of travel (undivided roadways only) and at any other points determined by the Engineer. Install signs prior to the obliteration of any pavement markings. Remove these signs at the completion of the project.

3- BASIS OF PAYMENT.

No direct payment will be made for Work Zone Signing as such work will be considered incidental to the various other bid items in the Contract.

R-3

BARRICADES

01-18-05_R

Revise the *2002 Standard Specifications* as follows:

Page 11- 12, **Article 1145-2 Materials**, delete the contents and substitute the following:

(A) General

Refer to Division 10:

Barricades..... Article 1089-3

(B) Material Qualifications

Provide Type III barricades and barricade rails that are listed on the North Carolina Department of Transportation's approved product list or accepted as traffic qualified by the Traffic Control Unit. For more information on the Traffic Qualification process, contact the Traffic Control Unit at Century Center Building B, 1020 Birch Ridge Drive, Raleigh, NC 27610; (919) 250-4159, or see the approved product list on the NCDOT web site at: www.doh.dot.state.nc.us/construction/tc/Apv_Prod/apv_prod.htm

(C) Historical Performance:

Historical performance of Type III barricades and barricade rails will be used in determining future use of the material by the NCDOT, even if the Type III Barricade is traffic-qualified. Poor past or poor current performance of Type III Barricades at any site, whether or not related to a specific contract may be grounds for non-acceptance of a product on any project under contract.

MEASUREMENT AND PAYMENT

No direct payment will be made for Barricades as such work will be considered incidental to other bid items.

R9

WBS#: 12CR.10231.3, 12CR.20231.3, 12CR.302303.2, 12CR.302318.2, 12CR.302319.2,
12CR.302339.1, 12CR.302334.1, 12CR.302399.1, 12CR.302314.1 Cleveland County

Date: 12-22-2004

Revised:

TRAFFIC CONTROL:

Maintain traffic in accordance with Divisions 11 and 12 of the North Carolina Department of Transportation January 2002 Standard Specifications for Roads and Structures, the latest revisions thereto and the following provisions:

Use a lane closure (refer to North Carolina Department of Transportation January 2002 Highway Design Branch Roadway Standard Drawings Nos. 1101.02, 1101.11, 1110.02, Detail for 1130D01 and details for the Advance Work Zone signing in contract) or a slow-moving operation as shown in details of this contract. Use a moving operation only if the minimum speed maintained at all times is 3 mph with no stops that narrow or close a lane of travel. If the moving operation is progressing slower than 3 mph at any time, install a lane closure. Maintain the existing traffic pattern at all times, except in the immediate work zone where lane closures are allowed as determined by the Engineer.

Refer to Attached Detail(s) and North Carolina Department of Transportation January 2002 Highway Design Branch Roadway Standard Drawings Nos. 1101.02, 1101.03, 1101.05, 1101.07, 1101.11, 1110.01, 1110.02, 1115.01, 1135.01, 1145.01, 1150.01, 1165.01, 1170.01 and **Detail for 1101D04** when closing a lane of travel in a stationary work zone such as pavement patching, resurfacing, or pavement marking removal, etc. Properly ballasted cones may be used instead of drums for lane closures during daylight hours. The stationary work zone shall be a maximum of 3 miles in length at any given time unless otherwise directed by the Engineer. A "pilot vehicle" operation may be used in conjunction with flaggers and the appropriate pilot vehicle warning signing as directed by the Engineer. During periods of construction inactivity, return the traffic pattern to the existing alignment and remove or cover any work zone signs. When covering work zone signs, use an opaque material that prevents reading of the sign at night by a driver using high beam headlights. Use material, which does not damage the sign sheeting. Replace any obliterated markings as required by other sections of the Specifications and the Engineer.

When personnel and/or equipment are working on the shoulder adjacent to an undivided facility and within 5 feet of an open travel lane, close the nearest open travel lane using Roadway Standard Drawing No. 1101.02 unless the work area is protected by barrier or guardrail. When personnel and/or equipment are working on the shoulder, adjacent to a divided facility and within 10 feet of an open travel lane, close the nearest open travel lane using Roadway Standard Drawing No. 1101.02 unless the work area is protected by barrier or guardrail. When personnel and/or equipment are working within a lane of travel of an undivided or divided facility, close the lane according to the traffic control plans, roadway standard drawings or as directed by the Engineer. Conduct the work so that all personnel and/or equipment remain within the closed travel lane. Do not work simultaneously, on both sides of an open travel way, within the same location, on a two-lane, two-way road. Do not perform work involving heavy equipment within 15 feet of the edge of travel way when work is being performed behind a lane closure on the opposite side of the travel way. **Perform work only when weather and visibility conditions allow safe operations as directed by the Engineer.**

The maximum acceptable drop-off between open lanes of travel is 2 inches. For drop-offs greater than 1.5 inches but less than or equal to 2 inches, place a 1:1 asphalt wedge between the lanes of travel. Where a drop-off in a travelway exceeds 2 inches but is less than or equal to 3 inches the affected lane(s) shall be closed to traffic. Where a drop-off in a travelway is greater than 3 inches the affected lane(s) shall be closed to traffic and the drop-off protected with drums. For all drop-offs between open lanes, advance warning "UNEVEN LANES" signs (W8-11 at 48' X 48") shall be installed 500 feet in advance and once every half mile where the posted speed is less than 45 mph and once every mile where the posted speed is greater than or equal to 45 mph throughout the length of the drop-off area.

The maximum acceptable edge of pavement drop-off is 2 inches. Backfill at a 6:1 slope up to the edge and elevation of existing pavement in areas adjacent to an open travel lane if the drop-off exceeds 2 inches at no expense to the Department.

When utilizing a slow-moving operation for such items as pavement marking placement, pavement marker installation and pesticide spraying, the slow moving operation caravan shall consist, as a minimum, of the vehicles and devices shown on the Moving Operation Caravan Detail(s) herein. Traffic cones may be used when necessary to provide additional protection of wet pavement markings. Ballast all traffic cones so they will not be blown over by traffic.

Submit a sequence of operation for all maps to the Engineer at the first pre-construction meeting for approval by the Engineer. Approved sequence can not be altered without written permission of the Engineer.

Notify the Engineer forty-eight (48) hours before milling or resurfacing will interfere with the existing Signal Loops. Loops may need to be placed in milled surface before resurfacing occurs. Coordinate all signal loop operations with the Engineer.

Notify the Engineer fifteen (15) consecutive calendar days before resurfacing a bridge or its approaches. Patch and make repairs to bridge surface and its approaches before resurfacing occurs. Coordinate all operations on the bridge and its approaches with the Engineer.

Notify the Engineer forty-eight (48) hours before resurfacing the areas of existing pavement that require patching. Patch these areas before resurfacing occurs. **Allow full depth asphalt patching to cool to the point of supporting traffic without displacement or rutting before reopening closed lane.** Coordinate the resurfacing operations of the patched areas with the Engineer.

During a resurfacing only operation, bring all newly resurfaced lanes to the same elevation within 72 hours.

For partial or "wheel track" milling operations on two-way, two-lane facilities, mill and pave back by the end of each work day. For partial or "wheel track" milling operations on multi-lane facilities, the lane being milled may be left closed and paved back within 72 hours.

The following options are acceptable during Resurfacing/milling operations on two-way, two-lane facilities when the entire roadway or entire lane is to be milled:

- 1) Mill a single lane and pave back by the end of each work day
- 2) Mill the entire width of roadway and pave back within 72 hours

The following options are available during Resurfacing/milling operations on multi-lane facilities when all lanes or a single lane in one direction are to be milled:

- 1) Mill the entire width of pavement for all lanes to be milled in any given direction daily and pave back within 72 hours.
- 2) Mill a single lane and pave back by the end of each work day
- 3) Mill a single lane, leave a lane closure in and pave back within 72 hours.

Slope the pavement at the beginning and ending of the daily milling operation as directed by the Engineer. Sweep and remove all milled material from the roadway as soon as the daily milling operation is completed. Maintain all accesses where milling is conducted using suitable backfill material approved by the Engineer. Continue milling operations until the particular section of roadway being milled is complete.

Operate equipment and conduct operations in the same direction as the flow of traffic. Do not cross medians with equipment, except at properly designated interchanges.

Review and record the existing pavement markings and markers prior to resurfacing. Use the record of existing pavement markings and markers in conjunction with North Carolina Department of Transportation January 2002 Highway Design Branch Roadway Standard Drawings to re-establish the proposed pavement markings and markers unless otherwise directed by the Engineer.

Provide appropriate lighting in accordance with Section 1413 of the North Carolina Department of Transportation January 2002 Standard Specifications for Roads and Structures when electing to perform paving at night at no expense to the Department.

Remove existing pavement markers in preparation for paving. Repair any pavement damage due to existing pavement marker removal **prior to the end of the work day**. Dispose of existing pavement markers as directed by the Engineer. **No direct payment will be made for this work, as it will be incidental to the paving operation.**

No direct payment will be made for the signing and traffic control items including Truck Mounted Impact Attenuators (TMIA – see Section 1165 of the NCDOT January 2002 Standard Specifications for Roads and Structures and January 2002 Highway Design Branch Roadway Standard Drawings). This work will be considered incidental to the various other bid items in the Contract.

R-1Revised

WBS#: 12CR.10231.3, 12CR.20231.3, 12CR.302303.2, 12CR.302318.2, 12CR.302319.2,
12CR.302339.1, 12CR.302334.1, 12CR.302399.1, 12CR.302314.1 . Cleveland County

Date: 12-22-2004

Revised:

**TIME LIMITATION FOR PLACEMENT AND REPLACEMENT
OF PAVEMENT MARKINGS AND MARKERS COMPLETED BY CONTRACTORS
ON NEWLY RESURFACED AREAS**

MARKING BY CONTRACTOR: DIVIDED AND MULTI-LANE FACILITIES

For all Interstate highways and access ramps, place all markings including symbols and legends, by the end of each workday's operation.

For all divided and multi-lane facilities, place all center line and lane line markings and railroad and school symbols by the end of each workday's operation. Place all edge lines, gore lines, and other symbols within 3 calendar days after they have been obliterated by the resurfacing operation.

A Multi-lane facility is defined as any roadway having more than two lanes to include a two-lane/two-way with a center two-way left turn lane.

MARKING BY CONTRACTOR: TWO-LANE, TWO-WAY FACILITIES

For all two-lane, two-way facilities, place all center line markings, railroad and school symbols within 5 calendar days after they have been obliterated by the resurfacing operation. Place all edge lines and other symbols within 30 calendar days after they have been obliterated by the resurfacing operation.

MARKING BY CONTRACTOR: ALL FACILITIES

Place two applications of paint on newly resurfaced asphalt which will remain in place over three (3) months. Place the second application of paint upon ample drying time of the first, as determined by the Engineer.

Place temporary pavement marking lines in areas designated by the Engineer.

Place Intermediate Paint in one application. If Intermediate Paint will remain in place over three (3) months, place two applications. The quantity of Intermediate Paint to be paid for shall be the actual number of linear feet (LF) or each (EA) which have been satisfactorily placed and accepted by the Engineer. Payment will be made as described in *Article 1205-6 Basis of Payment* in the *January 2002 Standard Specifications For Roads and Structures*.

MARKERS BY CONTRACTOR: ALL FACILITIES

Install permanent pavement markers within sixty (60) calendar days after completing the resurfacing on each map.

WBS#: 12CR.10231.3, 12CR.20231.3, 12CR.302303.2, 12CR.302318.2, 12CR.302319.2,
12CR.302339.1, 12CR.302334.1, 12CR.302399.1, 12CR.302314.1 Cleveland County

Date: 12-22-2004

Revised:

USE IN CONJUNCTION WITH 2002 STANDARD SPECIFICATIONS

THE FOLLOWING ROADWAY STANDARDS DRAWINGS AS THEY APPEAR IN THE "HIGHWAY DESIGN BRANCH ROADWAY STANDARD DRAWINGS" - ROADWAY DESIGN UNIT - N.C. DEPARTMENT OF TRANSPORTATION - RALEIGH, N.C., DATED JANUARY, 2002 AND THE LATEST REVISIONS THERETO ARE APPLICABLE TO THIS PROJECT AND BY REFERENCE HEREBY ARE CONSIDERED A PART OF THESE PLANS:

STANDARD PAVEMENT MARKINGS

ROADWAY STANDARD DRAWINGS: 1205.01, 1205.02, 1205.03, 1205.04, 1205.05,
1205.06, 1205.07, 1205.08, 1205.09, 1205.10,
1205.11, 1205.12

RAISED PAVEMENT MARKERS

ROADWAY STANDARD DRAWINGS: 1250.01, 1251.01

SNOWPLOWABLE PAVEMENT MARKERS

ROADWAY STANDARD DRAWINGS: 1250.01, 1253.01

WBS#: 12CR.10231.3, 12CR.20231.3, 12CR.302303.2, 12CR.302318.2, 12CR.302319.2,
 12CR.302339.1, 12CR.302334.1, 12CR.302399.1, 12CR.302314.1 Cleveland County

Date: 12-22-2004

Revised:

TRAFFIC CONTROL

01-18-05

Revise the *2002 Standard Specifications* as follows:

Article 1089-1 WORK ZONE SIGNS is deleted. Substitute the following:

(A) General:

Rigid sign retroreflective sheeting requirements for Types VII, VIII and IX (prismatic) fluorescent are described in Tables 1089-A, 1089-B and 1089-C. Cover the entire sign face of the sign substrate with NCDOT approved Type VII, VIII or IX (prismatic) fluorescent orange reflective sheeting. Apply the reflective sheeting in a workmanlike manner so that there are no bubbles or wrinkles in the material.

Roll-up sign retroreflective requirements are described in Table 1089-D.

1. Work Zones Signs (Stationary)

Use Type VII, VIII or IX (prismatic) fluorescent orange retroreflective sheeting that meets the following reflective requirements in Tables 1089-A, 1089-B or 1089-C respectively. Use approved composite or aluminum for sign backing. Signs and sign supports must meet or exceed NCHRP 350 requirements for Breakaway Devices.

Table 1089-A		
Minimum Coefficient of Retroreflection R_A for TYPE VII Fluorescent Orange Sheeting (Candelas per lux per square meter)		
Observation Angle	Entrance Angle	
	-4°	30°
0.1°	300	170
0.2°	230	130
0.5°	72	41

Table 1089-B Minimum Coefficient of Retroreflection R_A for TYPE VIII Fluorescent Orange Sheeting (Candelas per lux per square meter)		
Observation Angle	Entrance Angle	
	-4°	30°
0.1°	300	135
0.2°	210	95
0.5°	75	35

Table 1089-C Minimum Coefficient of Retroreflection R_A for TYPE IX Fluorescent Orange Sheeting (Candelas per lux per square meter)		
Observation Angle	Entrance Angle	
	-4°	30°
0.1°	200	110
0.2°	115	65
0.5°	72	41
1.0°	24	14

2. Work Zones Signs (Barricade Mounted)

Use approved composite or roll-up signs for barricade mounted sign substrates. Approved composite barricade mounted warning signs (black on orange) must be Type VII, VIII or IX sheeting which meet the retroreflective requirements of Table 1089-A, 1089-B or 1089-C. Roll-up mounted barricade warning signs (black on orange) must meet the retroreflective requirements in Table 1089-D. Sign and barricade assembly must meet or exceed the requirements of NCHRP 350 for Work Zone Category II Devices.

3. Work Zones Signs (Portable)

Use approved composite or roll-up sign substrates on portable sign stands.

Composite - Use Type VII, VIII or IX (prismatic) fluorescent orange retroreflective sheeting that meets the following reflective requirements in Tables 1089-A, 1089-B or 1089-C. Signs and sign supports must meet or exceed NCHRP 350 requirements for Breakaway Devices.

Roll-up Signs - Use fluorescent orange retroreflective roll-up signs that meet the following reflective requirements:

Table 1089-D Minimum Coefficient of Retroreflection R_A for Fluorescent Orange Roll-Up Signs (Candelas per lux per square meter)		
Observation Angle	Entrance Angle	
	-4°	30°
0.1°	300	120
0.2°	200	80
0.5°	90	34

Use roll up signs that have a minimum 3/16" x 1 1/4" horizontal rib and 38" x 1 1/4" vertical rib and has been crash test to meet NCHRP 350 requirements and Traffic Control qualified by the Work Zone Traffic Control Unit.

Add the following after 1089-1(C):

(D) Warranty

Warranty requirements for rigid sign retroreflective sheeting Types VII, VIII and IX are described in Section 1093-9 (F) and Tables 1089 A, B and C.

Roll-up fluorescent orange retroreflective signs will maintain 80% of its retroreflectivity (Table 1089-D) for years 1 – 2 and 50% for year 3.

Rigid and Rollup Fluorescent orange signs will maintain a Fluorescence Luminance Factor (Y_F)* of 13% for three (3) years.

*Fluorescence Testing Method is described in ASTM E2301 Test Methods for Fluorescent Retro reflective Sheeting.

Rigid and Roll up fluorescent orange signs shall maintain a total Luminance Factor (Y) of 25 for three (3) years and conform to the requirements of Table 1089-E when measured in accordance with ASTM D4956.

Table 1089-E Fluorescent Orange colorimetric requirements								
Color	1		2		3		4	
	x	y	x	y	x	y	x	y
Fluorescent Orange	0.583	0.416	0.535	0.400	0.595	0.351	0.645	0.355

BARRICADES

Article 1089-3(A) General, delete both paragraphs and substitute the following:

Type III Barricades shall be constructed of perforated square steel tubing and/or angle iron. Provide Type III barricades that use a cross member or stabilization bar and meet the requirements of NCHRP 350 for Work Zone Category II Devices with composite and roll-up signs attached.

Use approved composite or plastic barricade rails that have a smooth face and have alternating orange and white retroreflective stripes that slope at an angle of 45 degrees.

Article 1089-3(C) Reflective Sheeting, delete the first paragraph only and substitute the following:

Use Type VII, VIII or IX (prismatic) retroreflective fluorescent orange sheeting on both sides of the barricade rails. The rail sheeting retroreflectivity values shall meet the retroreflectivity requirements in Table 1089-A, 1089-B or 1089-C and shall be listed on the Department's approved product list or accepted as traffic qualified by the Traffic Control Unit.

R7

WBS#: 12CR.10231.3, 12CR.20231.3, 12CR.302303.2, 12CR.302318.2, 12CR.302319.2, 12CR.302339.1, 12CR.302334.1, 12CR.302399.1, 12CR.302314.1 Cleveland County

Date: 12-22-2004

Revised:

WORK ZONE SIGNS

01-18-05_R

Revise the *Standard Specifications* as follows:

DESCRIPTION

Page 11-5, **Article 1110-1 Description**

Replace the second paragraph with the following:

Furnish, install, maintain and relocate portable work zone signs and portable work zone sign stands in accordance with the plans and specifications. When portable work zone signs and portable work zone sign stands are not in use for periods longer than 30 minutes, collapse sign stand and reinstall once work begins.

Replace the last sentence in the third paragraph with the following:

Use work zone signs (portable) only with portable work zone sign stands specifically designed for one another. Work Zone Signs (portable) may be roll up or approved composite.

MATERIALS

Page 11-5, **Article 1110-2 Part (A) General:**

Add the following:

Barricade Mounted Signs.....Article 1089-3

MATERIAL QUALIFICATIONS

Page 11-5, **Article 1110-2 (B) Material Qualifications.**

Delete the first sentence in the first paragraph and replace with the following:

Provide portable work zone sign stands, portable signs and sign sheeting which are listed on the North Carolina Department of Transportation’s approved product list or accepted as traffic qualified by the Traffic Control Unit.

Page 11-6, **Article 1110-2 (B) Material Qualifications**

Delete “Traffic Control Section” in the second sentence of the first paragraph and insert “Traffic Control Unit”.

CONSTRUCTION METHODS

Page 11-6, Replace **Article 1110-3 Construction Methods**

Replace **Article 1110-3 (B) Work Zone Signs (Barricade Mounted)** with the following:

Mount approved composite or roll-up signs to barricade rails so that the signs do not cover more than 50 percent of the top two rails or 33 percent of the total area of the three rails. Signs are to be mounted a minimum of 1’ from the ground to the bottom of the sign.

Replace **Article 1110-3 (C) 2. Work Zone Signs (Portable)** with the following:

Install portable work zone signs to carry roll-up or approved composite at a minimum height of 1’ from the bottom of the sign to the ground on two lane-two way roadways.

Install portable work zone signs to carry roll-up or approved composite at a minimum height of 5’ from the bottom of the sign to the ground on multi-lane roadways.



MEASUREMENT AND PAYMENT

No direct payment will be made for Work Zone Signs as such work will be considered incidental to other bid items in the contract.

GENERAL NOTES

- (1) THE FOLLOWING OPTIONS MAY BE USED FOR ADVANCE WARNING SIGNS:
 - A. TRUCK MOUNTED SIGNS
 - B. TRUCK MOUNTED CHANGEABLE MESSAGE SIGN (CMS)
 - C. GROUND MOUNTED ADVANCE WARNING SIGNS (MUST CIRCLE TO PICK UP SIGNS)
 - D. GROUND MOUNTED CHANGEABLE MESSAGE SIGN (CMS) (MUST USE CIRCLE TO PICK UP SIGNS)
- (2) ALL ADVANCE WARNING SIGNS MUST BE 48" X 48" WITH FLUORESCENT ORANGE YELLOW REFLECTIVE VITRIFIED GLASS SHEETING. IF SPACE LIMITATIONS ON SHOULDER PROHIBIT 48" X 48" SIGN, A SMALLER SIGN CAN BE USED WITH APPROVAL FROM ENGINEER.
- (3) SIGNS ON VEHICLES SHOULD BE MOUNTED A MINIMUM OF ONE (1) FOOT FROM THE GROUND AND SHOULD NOT BLOCK THE MOTORIST'S SIGHT OF THE FLASHING ARROW PANEL AND/OR LIGHTBAR.
- (4) GROUND MOUNTED ADVANCED WARNING SIGNS SHOULD BE MOUNTED A MINIMUM OF ONE (1) FOOT FROM THE GROUND TO BOTTOM OF SIGN.
- (5) SIGN SPACING SHOULD BE ADJUSTED FOR HORIZONTAL AND VERTICAL CURVES, ETC. TO IMPROVE SIGHT DISTANCES.
- (6) ADDITIONAL VEHICLES SHOULD BE USED IN WORK CARAVAN TO FACILITATE DRYING OF PAVEMENT MARKING MATERIAL (TMA'S ARE OPTIONAL ON THESE ADDITIONAL VEHICLES) HOWEVER, THE FIRST VEHICLE MOTORISTS SEE IN THE TRAVEL LANE SHALL HAVE A TMA.
- (7) ADJUST DISTANCE AS NEEDED TO PREVENT MOTORISTS FROM ENTERING SPACE BETWEEN THE APPLICATION AND PROTECTION VEHICLE. DISTANCE CAN BE LENGTHENED TO ACCOMMODATE SIGHT DISTANCE NEEDS.
- (8) ROUND UP MILEAGE TO NEXT WHOLE MILE. WORK ZONE SHOULD NOT EXCEED FIVE (5) MILES IN LENGTH.
- (9) RADIO COMMUNICATION BETWEEN VEHICLES IS REQUIRED.
- (10) USE OF A LIGHT BAR ON ALL VEHICLES IS PREFERRED, BUT A ROTATING BEACON MAY BE USED INSTEAD.
- (11) IF WORK IS PERFORMED AT NIGHT, THE WORK AREA MUST BE ILLUMINATED WITH MACHINE AND/OR TOWER LIGHTS AS APPROVED BY THE ENGINEER.
- (12) ALL TRAFFIC CONTROL DEVICES WILL BE CONSIDERED INCIDENTAL TO THE PAVEMENT MARKING AND WARNERS.
- (13) INFORMATIONAL SIGNS SHOULD BE ACTIVITY SPECIFIC. I.e. "PAINT CREW IN ROAD" SIGNS MAY BE RECTANGULAR OR DIAMOND SHAPE. SIGN SIZE SHOULD BE BASED ON THE MOTORIST ABILITY TO RECOGNIZE SIGN WHEN TRAVELING FIVE (5) MILES ABOVE POSTED SPEED LIMIT.
- (14) IF A LEAD VEHICLE IS ADDED TO OPERATION, IT SHOULD HAVE THE SAME ADVANCE WARNING SIGNS AS THE APPLICATION VEHICLE SHOWN BELOW.

LEGEND

- K1 PORTABLE SIGN. SIGNS MUST BE NCHRP-350 AND NDOT APPROVED.
- ➔ DIRECTION OF TRAFFIC FLOW
-  APPLICATION VEHICLE WITH LIGHT BAR
-  PROTECTION VEHICLE WITH TRUCK AND LIGHT BAR (SEE ROADWAY TMA STANDARD NO. 105-01). TMA MUST BE NCHRP-350 TEST LEVEL 3 (80-MPH) APPROVED.
-  FLASHING ARROW PANEL, TYPE "B" (80"/30" MIN.), "CAUTION MODE"

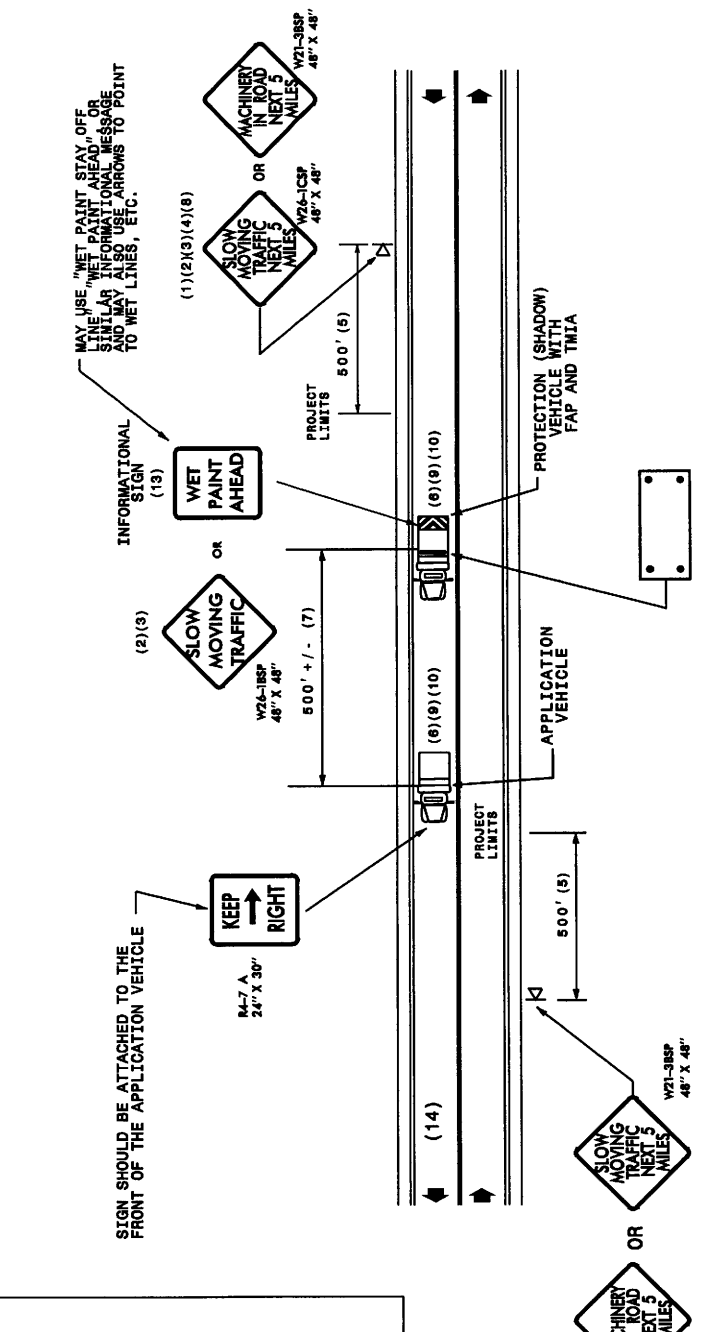
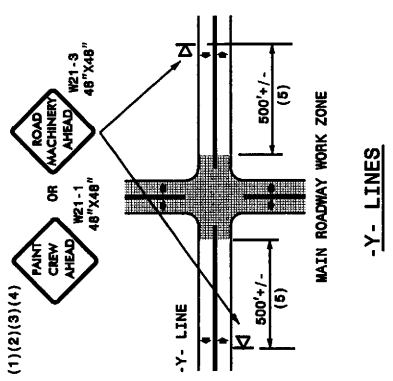

MOVING OPERATION CARAVAN
 (OPERATIONS TRAVELING 3 MPH OR FASTER)
 PLACING PAVEMENT MARKING OR MARKERS
 ON TWO-LANE TWO-WAY ROADWAYS

DRAWING NUMBER 6
 IMPLEMENTATION DATE: 07/01/97
 REVISED: 11/03/04

GENERAL NOTES

- (1) THE FOLLOWING OPTIONS MAY BE USED FOR ADVANCE WARNING SIGNS:
 - A. TRUCK MOUNTED CHANGEABLE MESSAGE SIGN (CMS)
 - B. TRUCK MOUNTED ADVANCE WARNING SIGN (TMA)
 - C. GROUND MOUNTED ADVANCE WARNING SIGN (MUST CIRCLE TO PICK UP SIGNS)
 - D. GROUND MOUNTED CHANGEABLE MESSAGE SIGN (CMS) (MUST USE CIRCLE TO PICK UP SIGNS)
- (2) ALL ADVANCE WARNING SIGNS MUST BE 48" X 48" WITH FLUORESCENT ORANGE TYPE VII, VIII OR IX SHEETING. IF SPACE LIMITATIONS ON SHOULDER PROHIBIT A 48" X 48" SIGN, A SMALLER SIGN CAN BE USED WITH APPROVAL FROM ENGINEER.
- (3) SIGNS ON VEHICLES SHOULD BE MOUNTED A MINIMUM OF ONE (1) FOOT FROM THE GROUND AND SHOULD NOT BLOCK THE MOTORIST'S SIGHT OF THE FLASHING ARROW PANEL AND/OR LIGHTBAR.
- (4) GROUND MOUNTED ADVANCED WARNING SIGNS SHOULD BE MOUNTED A MINIMUM OF FIVE (5) FEET FROM THE GROUND TO BOTTOM OF SIGN.
- (5) SIGN SPACING SHOULD BE ADJUSTED FOR HORIZONTAL AND VERTICAL CURVES, ETC. TO IMPROVE SIGHT DISTANCES.

- (6) ADDITIONAL VEHICLES SHOULD BE USED IN WORK CARAVAN TO FACILITATE DRYING OF PAVEMENT MARKING MATERIAL. (TMA'S ARE OPTIONAL ON THESE ADDITIONAL VEHICLES). HOWEVER, THE FIRST VEHICLE MOTORISTS SEE IN THE TRAVEL LANE SHALL HAVE A TMA.
- (7) ADJUST DISTANCE AS NEEDED TO PREVENT MOTORISTS FROM ENTERING WORK ZONE BEFORE THEY CAN POSITION PROTECTION VEHICLE. DISTANCE CAN BE LENGTHENED TO ACCOMMODATE SIGHT DISTANCE NEEDS.
- (8) ROUND UP MILEAGE TO NEXT WHOLE MILE. WORK ZONE SHOULD NOT EXCEED FIVE (5) MILES IN LENGTH.
- (9) RADIO COMMUNICATION BETWEEN VEHICLES IS REQUIRED, BUT A ROTATING BEACON MAY BE USED INSTEAD.
- (10) USE OF A LIGHT BAR ON ALL VEHICLES IS PREFERRED, BUT A ROTATING BEACON MAY BE USED INSTEAD.
- (11) IF WORK IS PERFORMED AT NIGHT, THE WORK AREA MUST BE ILLUMINATED WITH MACHINE AND/OR TOWER LIGHTS AS APPROVED BY THE ENGINEER.
- (12) ALL TRAFFIC CONTROL DEVICES WILL BE CONSIDERED INCIDENTAL TO THE PAY ITEMS FOR PAVEMENT MARKING AND MARKERS.

LEGEND

- K
 - ▶
 -
 -
 -
 -
 -
- PORTABLE SIGN. SIGNS MUST BE NCHRP-350 AND NGDOT APPROVED.
DIRECTION OF TRAFFIC FLOW
APPLICATION VEHICLE WITH LIGHT BAR
PROTECTION VEHICLE WITH TRUCK MOUNTED IMPACT ATTENUATOR (TMIA)
ADVANCE WARNING VEHICLE WITH TRUCK MOUNTED CHANGEABLE MESSAGE SIGN
FLASHING ARROW PANEL, TYPE "B" (60"X30" MIN.)
APPROPRIATE DIRECTION INDICATED
CHANGEABLE MESSAGE SIGN

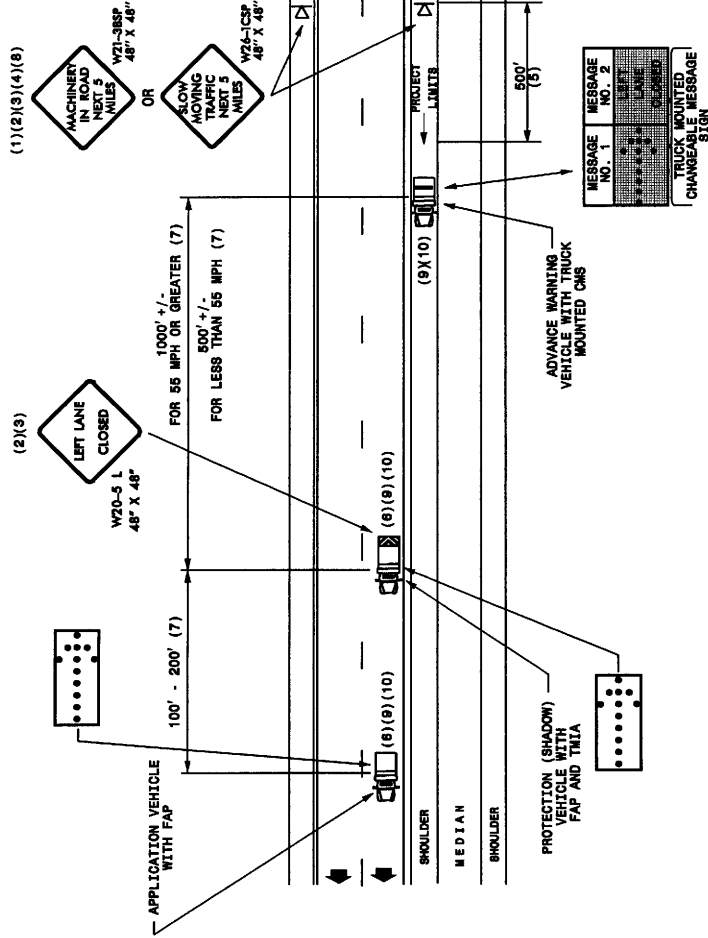
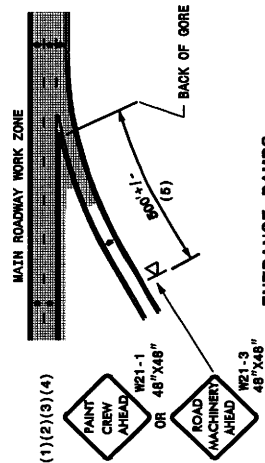
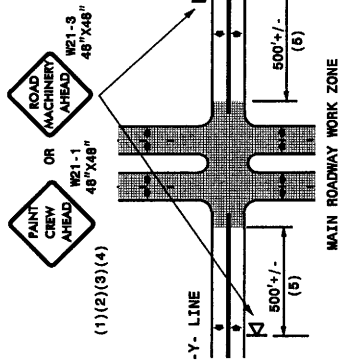

MOVING OPERATION CARAVAN

(OPERATIONS TRAVELING 3 MPH OR FASTER)
PLACING PAVEMENT MARKING OR MARKERS
ON NON-INTERSTATE MULTILANE DIVIDED ROADWAYS

DRAWING NUMBER 7
IMPLEMENTATION DATE: 07/01/97
REVISED: 11/03/04