

SECTION N-N

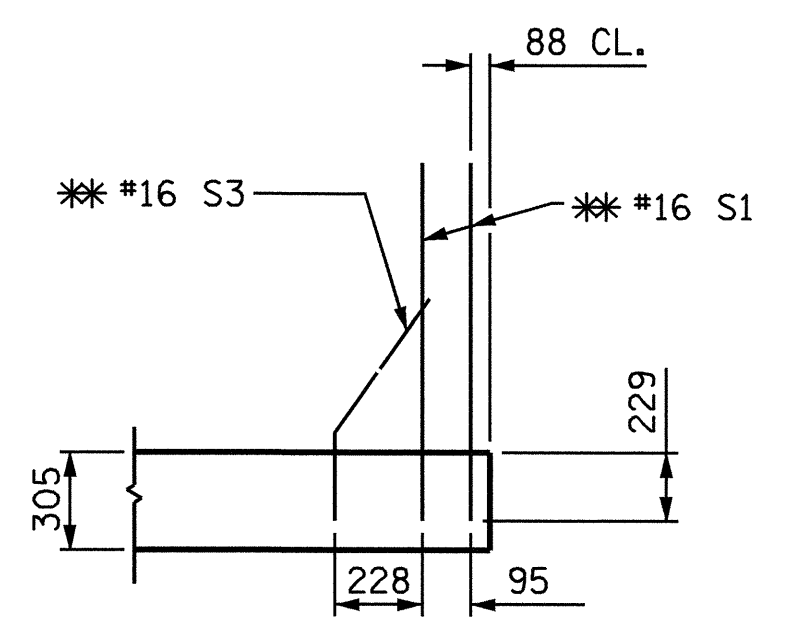

SECTION K-K
* ADHESIVELY ANCHORED

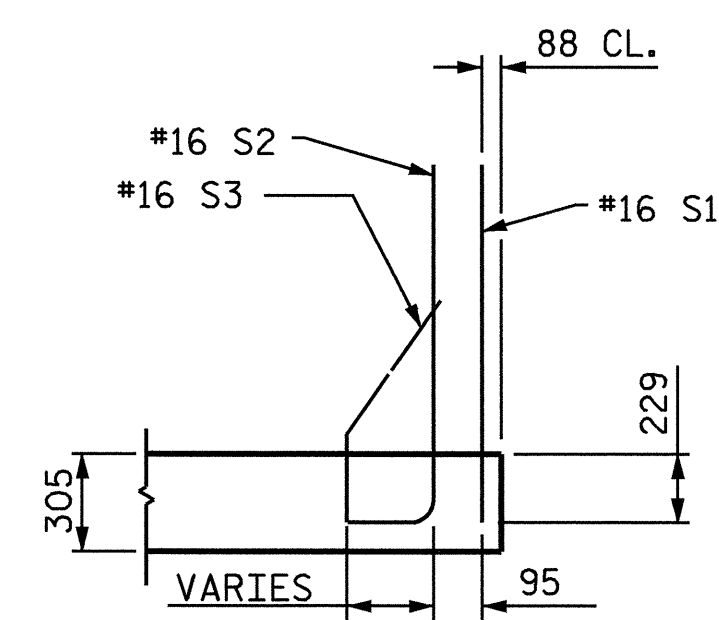

SECTION L-L

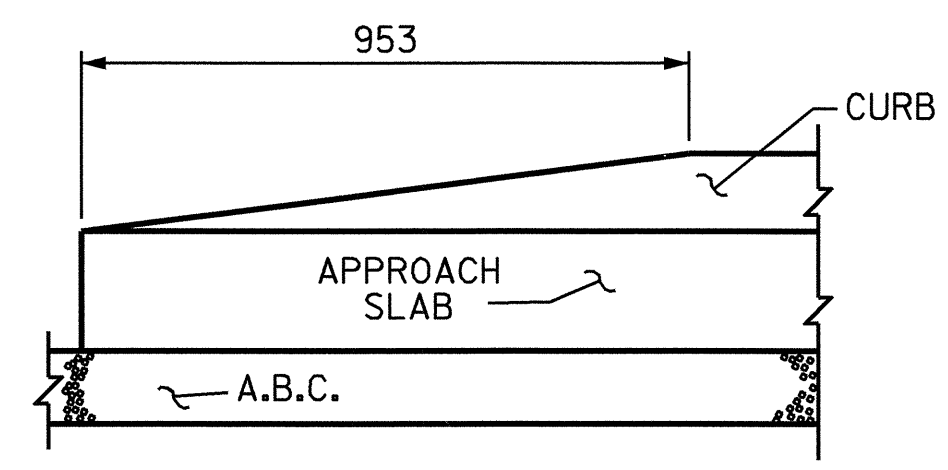

END OF CURB WITHOUT SHOULDER BERM GUTTER
CURB DETAILS

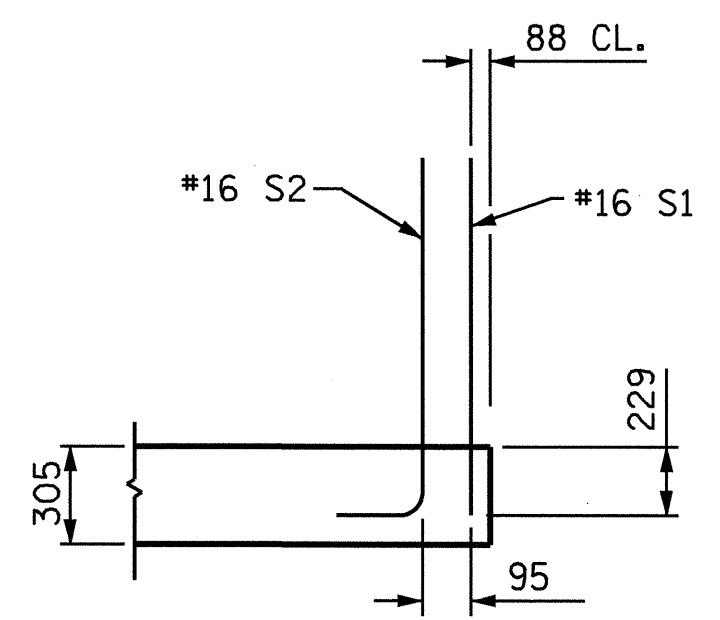

SECTION M-M

SEE SHEET 1 OF 4 FOR SECTION LOCATIONS

NOTES

THE COST OF THE BARRIER RAIL ON THE APPROACH SLAB SHALL BE INCLUDED IN THE LUMP SUM CONTRACT PRICE BID FOR BRIDGE APPROACH SLABS.

APPROACH SLAB SHALL NOT BE CONSTRUCTED PRIOR TO COMPLETION OF THE BRIDGE DECK.

FOR REINFORCED BRIDGE APPROACH FILL INCLUDING FABRIC, IMPERMEABLE GEOMEMBRANE, 102mm Ø DRAINAGE PIPE, #78M STONE, AND SELECT MATERIAL, SEE ROADWAY PLANS.

TEMPORARY DRAINAGE AND TEMPORARY BERM AND SLOPE DRAINS WILL BE PAID FOR UNDER THE LUMP SUM PRICE FOR BRIDGE APPROACH SLAB.

AREA BETWEEN THE WINGWALL AND APPROACH SLAB SHALL BE GRADED TO DRAIN THE WATER AWAY FROM THE FILL FACE OF THE BRIDGE.

THE 150mm COMP. A.B.C. SHALL EXTEND 3m BEYOND THE END OF THE APPROACH SLAB AND 300mm OUTSIDE OF EACH EDGE OF THE SLAB.

THE CONTRACTOR MAY USE 100mm TYPE B-25.0B ASPHALT CONCRETE COURSE IN LIEU OF 150mm COMP. A.B.C. IF THIS OPTION IS USED, THE BASE COURSE SHALL EXTEND 300mm BEYOND THE END OF THE APPROACH SLAB AND THE WIDTH SHALL BE THE SAME AS THAT OF THE APPROACH SLAB.

THE CONTRACTOR MAY USE 125mm CLASS "A" CONCRETE BASE IN LIEU OF 150mm COMP. A.B.C. IF THIS OPTION IS USED, THE CONCRETE BASE SHALL EXTEND 300mm BEYOND THE END OF THE APPROACH SLAB AND THE WIDTH SHALL BE THE SAME AS THAT OF THE APPROACH SLAB. THE CONCRETE SHALL BE FINISHED TO A SMOOTH SURFACE AND A LAYER OF 13.6 kg. ROOFING FELT SHALL BE PLACED BETWEEN THE CONCRETE BASE AND THE APPROACH SLAB TO PREVENT BOND. THE APPROACH SLAB SHALL NOT BE CAST UNTIL THE CONCRETE BASE HAS REACHED AN AGE OF THREE CURING DAYS.

THE JOINT SHALL BE SAWED PRIOR TO THE CASTING OF THE BARRIER RAIL.

WITH EVAZOTE JOINT SEAL

FOR EVAZOTE JOINT SEALS, SEE SPECIAL PROVISIONS.

THE NOMINAL UNCOMPRESSED SEAL WIDTH OF THE EVAZOTE JOINT SEAL SHALL BE 87mm @ EB #1, AND 64mm @ EB #2.

FOR ELASTOMERIC CONCRETE, SEE SPECIAL PROVISIONS.

BILL OF MATERIAL

FOR ONE APPROACH SLAB (2 REQ'D)

BAR	NO.	SIZE	TYPE	LENGTH	WEIGHT
*A1	26	#16	STR	11540	466
*A2	24	#16	STR	11680	435
A3	100	#13	STR	6120	608
*B1	78	#19	STR	7380	1287
B2	78	#25	STR	7520	2330
*B3	14	#16	STR	3560	77
*B4	1	#16	3	1960	3
*B5	1	#16	3	1920	3
*S1	58	#16	STR	980	88
*S2	42	#16	1	1220	80
*S3	20	#16	2	680	21

REINFORCING STEEL kg. 2938

*EPOXY COATED REINFORCING STEEL kg. 2460

CLASS AA CONCRETE BREAKDOWN

POUR	SLAB & CURB	C. M.	WEIGHT
POUR 1	SLAB & CURB	C. M.	27.6
POUR 2	RAIL	C. M.	1.6

CLASS AA CONCRETE C. M. 29.2

BAR TYPES

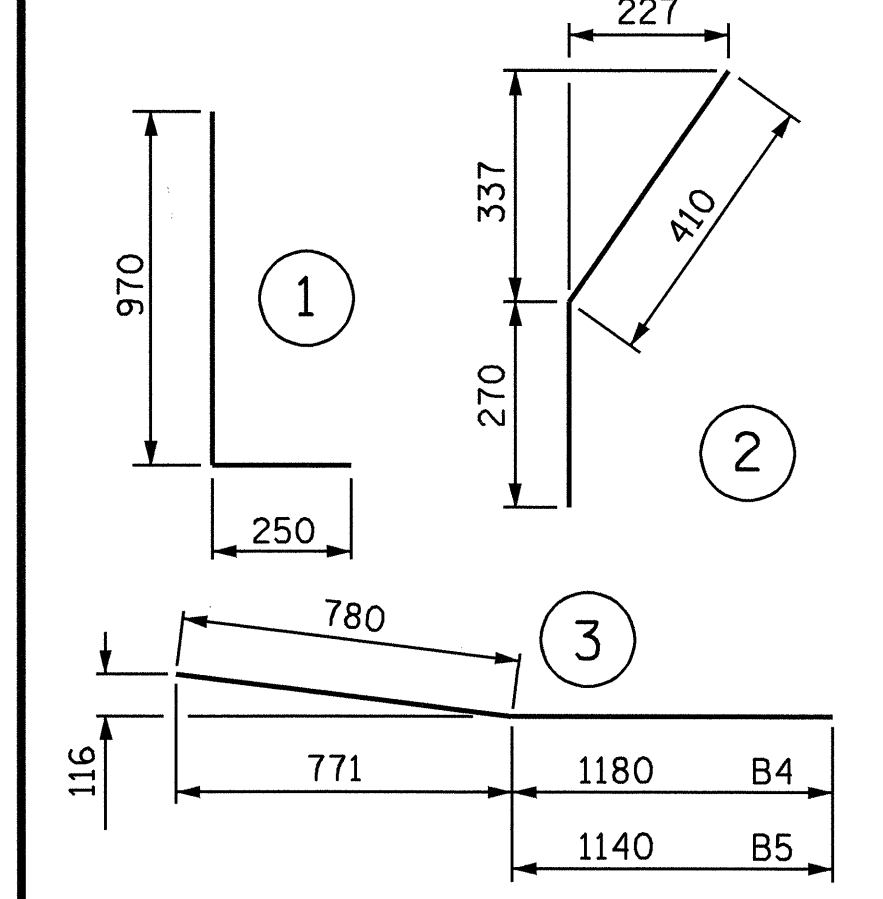

ALL BAR DIMENSIONS ARE OUT TO OUT

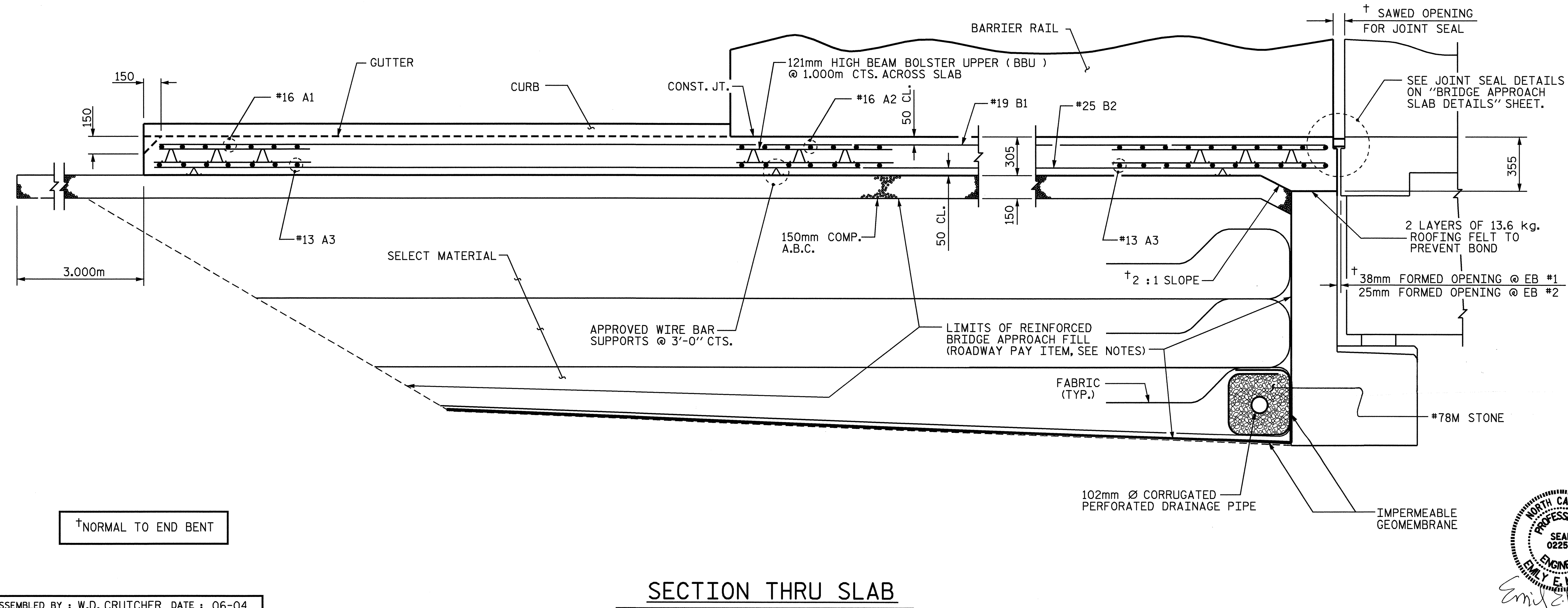

SECTION THRU SLAB

†NORMAL TO END BENT

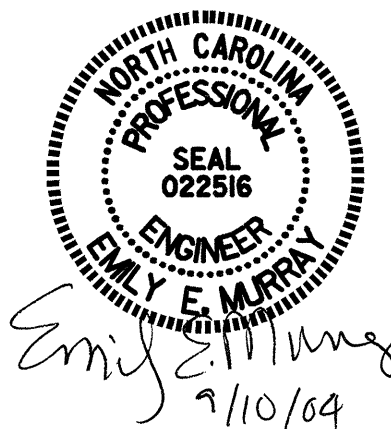

ASSEMBLED BY : W.D. CRUTCHER	DATE : 06-04
CHECKED BY : T.L. AVERETTE	DATE : 06-04
DRAWN BY : RWW	8/01
CHECKED BY : LES	8/01
ADDED	12/01
REV.	5/7/03
RWW/JTE	

PROJECT NO. R-2206C
LINCOLN-CATAWBA COUNTY
STATION: 237+97.199 -L-

SHEET 2 OF 4

STATE OF NORTH CAROLINA
DEPARTMENT OF TRANSPORTATION
RALEIGH

BRIDGE APPROACH SLAB FOR RIGID PAVEMENT WITH BARRIER RAIL
RIGHT LANE

REVISIONS						SHEET NO.	
NO.	BY:	DATE:	NO.	BY:	DATE:	TOTAL SHEETS	
1			3			3-200	
2			4			374	