

### High Speed Detection [≥40 mph (64 km/hr)]

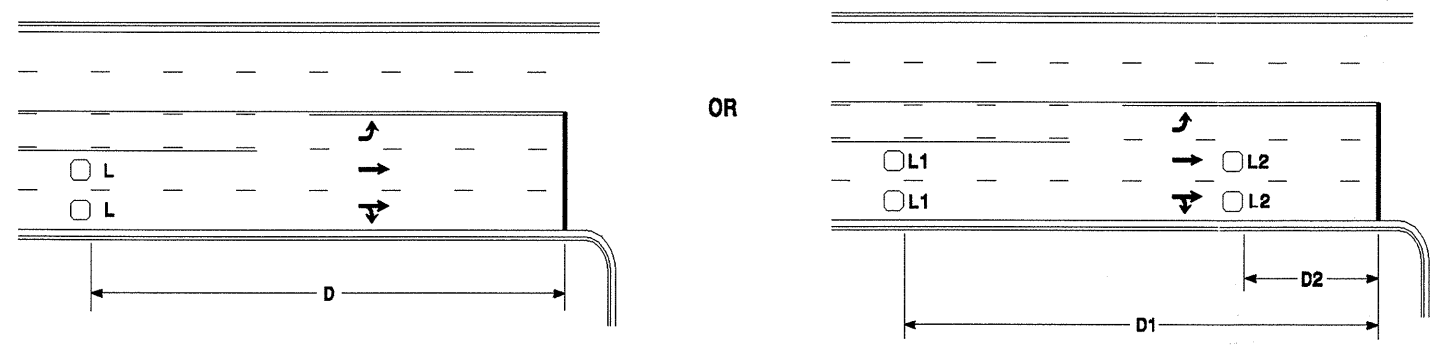

Speed Limit mph (km/hr)	D ft (m)
40 (64)	250 (75)
45 (72)	300 (90)
50 (80)	355 (110)
55 (88)	420 (130)

L = 6ft X 6ft (1.8m X 1.8m)  
Wired in series for TS1  
Controllers  
Wired separately for TS2,  
170, and 2070L Controllers

Speed Limit mph (km/hr)	D1 ft (m)	D2 ft (m)
40 (64)	250 (75)	80 (25)
45 (72)	300 (90)	90 (27)
50 (80)	355 (110)	100 (30)
55 (88)	420 (130)	110 (35)

L1 = 6ft X 6ft  
(1.8m X 1.8m)  
Wired in series  
L2 = 6ft X 6ft  
(1.8m X 1.8m)  
Wired in series

Volume Density Operation

"Stretch" Operation

### Low Speed Detection [≤35 mph (56 km/hr)]

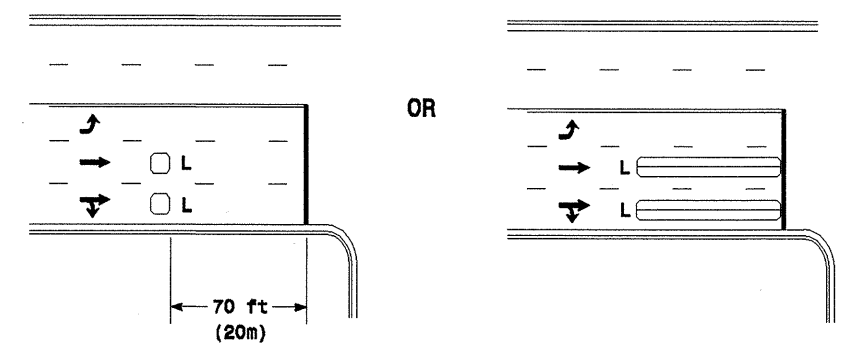

L = 6ft X 6ft (1.8m X 1.8m)  
Wired in series

L = 6ft X 60ft (1.8m X 18.0m)  
Quadrupole loop, wired separately

### Left Turn Lane Detection

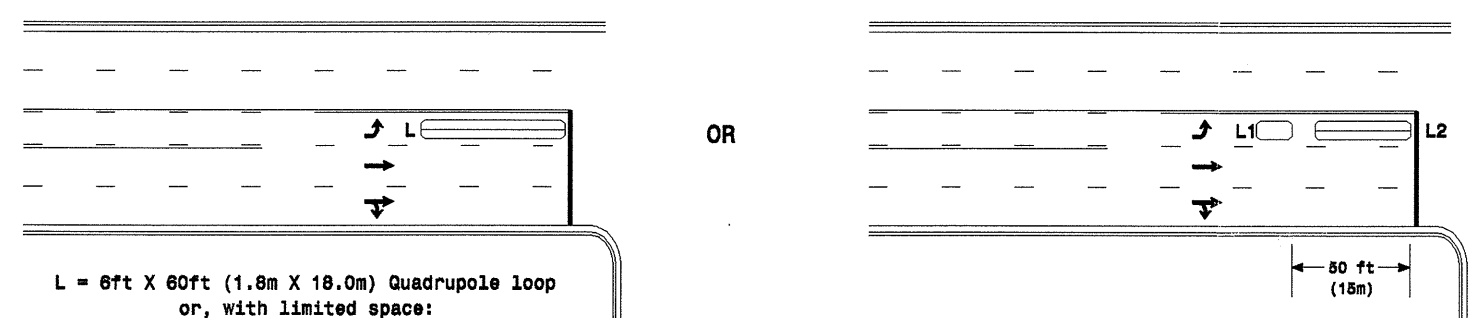

L = 6ft X 60ft (1.8m X 18.0m) Quadrupole loop  
or, with limited space:  
6ft X 50ft (1.8m X 15.0m) Quadrupole loop  
or  
6ft X 40ft (1.8m X 12.0m) Quadrupole loop

L1 = 6ft X 15ft (1.8m X 4.6m) Queue detector  
L2 = 6ft X 40ft (1.8m X 12.0m) Quadrupole loop

Presence Loop Detection

Queue Loop Detection

### Right Turn Lane Detection

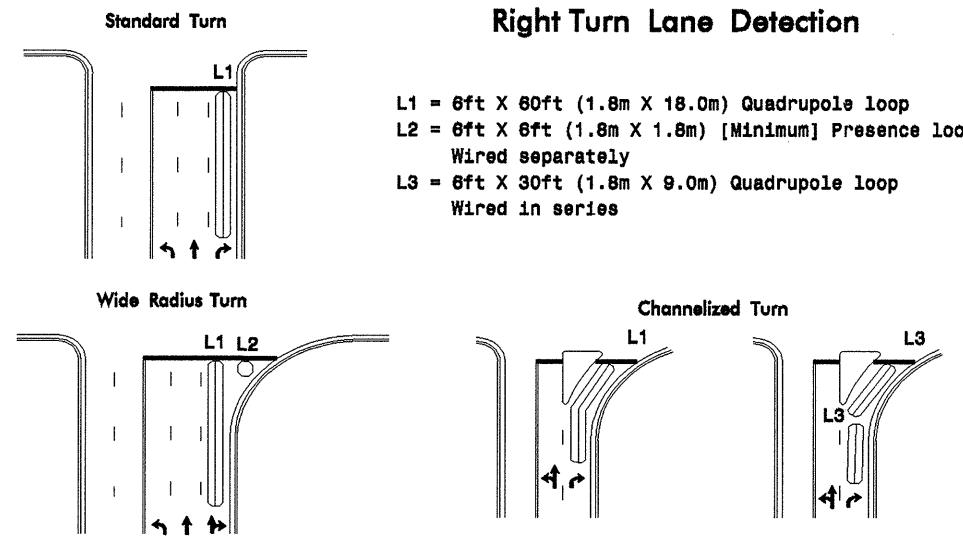

L1 = 6ft X 60ft (1.8m X 18.0m) Quadrupole loop  
L2 = 6ft X 6ft (1.8m X 1.8m) [Minimum] Presence loop  
Wired separately  
L3 = 6ft X 30ft (1.8m X 9.0m) Quadrupole loop  
Wired in series

### Side Street Detection

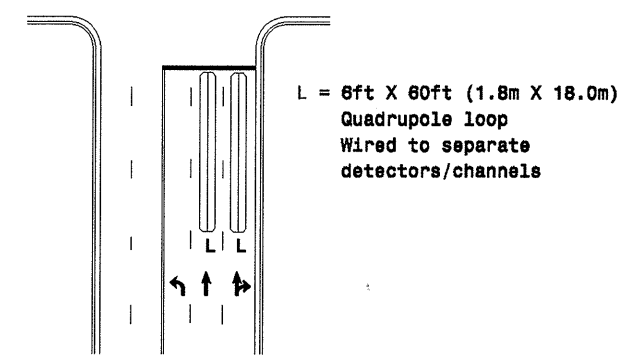

L = 6ft X 60ft (1.8m X 18.0m)  
Quadrupole loop  
Wired to separate  
detectors/channels

### Presence Loop Placement at Stop Lines

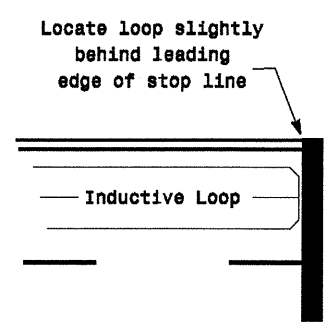

Note:  
Loop may be located in advance  
of stop line when stop line is  
greater than 15' (4.5m) from edge  
of intersecting roadway; or, when  
loop detects a permitted or  
exclusive/permitted left turn.

### Recommended Number of Turns

Single 6' X 6' (1.8m X 1.8m)  
loop (wired separately):

Length of Lead-in ft (m)	Number of Turns
< 250 (75)	3
250-375 (75-115)	4
375-525 (115-160)	5
> 525 (160)	6

Quadrupole loops:  
Use 2-4-2 turns

6' X 15' (1.8m X 4.6m) Loops:  
Lead-in < 150' (45 m), use 2 turns  
Lead-in > 150' (45 m), use 3 turns

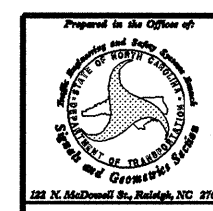

### Typical Loop Locations

PLAN DATE: August 2001	REVIEWED BY:
PREPARED BY: P. L. Alexander	REVIEWED BY:
REVISIONS	INIT. DATE
Add queue detector loop reference to 2070L controllers	ela 8/02

SCALE  
None

22-SEP-2004 11:00 AM C:\Users\paxton\Documents\7CR.10411.7\Folder\cop\_typ\001b.dgn